



MANZIM SURGICO

*Manufacturers & Exporters of Surgical, Dental Instruments
& Scissors all Sorts.*

Surgical Instruments Catalogue



Company Profile

Manzim surgico was founded over a quarter century ago to fill the need for old world craftsmanship, combined with our German technology and production know-how to achieve this unique combination of skills and instruments of the finest quality Manzim Surgico has devised and created New process, New quality control System .This concept has been building an enviable reputation in operating rooms throughout the world.

Products:

Manzim Surgico Strives to produce & Supply the latest and most comprehensive range of instruments, Due to rapid evolution in the field of biological science and constant revolution in surgical methodology,Manzim Surgico constantly review and update the product range with passage of time . All major production processes and performed in-house in production workshop.

Activity:

Manzim Surgico manufacture and Supply top quality Re-useable type and Single-use Surgical Instruments.

Quality Assurance:

Manzim Surgico prides itself on the rigorous quality control monitoring on every step from initial to final stage to ensure the supply of finest grade consistency instruments according to the required specifications supplied.

Certified Quality Awards:

Manzim Surgico's Production and quality comply with MD EEC 92/93 ,ISO 9001,ISO 13485 ,FDA ,CGMP,CE MARK .

Distribution:

Manzim Surgico's Instruments are distributed in South Korea,Spain, France, Germany, U.K, Rwanda, Australia,USA.

Customer Services:

Manzim Surgico is whole-heartedly committed to total customer satisfaction as our policy is Maximum Customer Satisfaction through: Best Quality Instruments, Competitive prices and on time Deliveries.

Contact No: 0092-52-3253436

Fax No: 0092-52-3253436

E-mail: support@manzimsurgico.com

info@manzimsurgico.com

Order Procedure:

When place an order by phone, fax or email please quote the following details.

- Order Number.
- Catalogue Number and description.
- Quantity
- Required Delivery Time.
- Special Marking (If any have)

Urgent Deliveries:

In case of urgency, we can dispatch orders within 1 to 2 weeks time.

Terms And Conditions:

The goods remain the property of Manzim Surgico until paid for in full. We only deal in terms of advance payment by T/T Telegraphic transfer or by irrevocable letter of credit L/C.

Guarantee:

MANZIM SURGICO Guaranteed unconditionally for three years, they clear boil and autoclave testing and are also passivated .The stainless steel to use manufacture instruments is the most suitable for the intended use of them. The fact that it will resist corrosion as it is further tested by different kind of chemical and physical testing. We use 410ss series of steel for non-cutting products and 420ss and french ss for cutting and scaling products.

Facility Address:

M/S: MANZIM SURGICO.

KHATANA STREET NEAR ISLAM MASJID,
P/O BOX 51310 S-I-E, SHATAB GARH, SIALKOT,
PAKISTAN.

TEL:0092-52-3253436

FAX:0092-52-3253436

EMAIL:info@manzimsurgico.com

sales@manzimsurgi.com

Web:www.manzimsurgico.com

Contacting Person: M.MUHAMMAD IMRAN
(Chief Executive)

Mobile # 0092-300-5159397
0092-307-5311117

01 DIAGNOSTIC INSTRUMENTS 01 To 13



02 TROCARS, SUCTION TUBES & CANNULAS 14 To 23



03 SCALPEL HANDLE, SCALPEL BLADES, DISSECTING KNIVES & SAWS 24 To 32



04 GENERAL OPERATING SCISSORS 33 To 60



05 DRESSING & TISSUE FORCEPS 61 To 78



06 HAEMOSTATIC FORCEPS 79 To 100



07 NEEDLE HOLDERS 101 To 126



08 RETRACTORS 127 To 161



09 Plastic SURGERY INSTRUMENTS 162 To 181



10 BONE SURGERY INSTRUMENTS 182 To 234



11 NEUROSURGERY INSTRUMENTS **235 To 262**



12 CARDIOVASCULAR & THORACIC INSTRUMENTS **263 To 284**

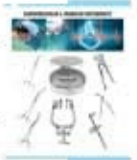

13 OPHTHALMIC INSTRUMENTS **285 To 294**



14 ENT SURGERY **295 To 337**



15 INTESTINAL AND RECTAL INSTRUMENTS **338 To 354**



16 UROLOGY INSTRUMENTS **355 To 368**



17 GYNECOLOGY / OBSTETRICS INSTRUMENTS **369 To 408**



18 LIPOSUCTION CANNULAS **409 To 423**



19 HOLLOW WARES **424 To 434**



DIAGNOSTIC INSTRUMENTS





Duplex Stethoscope 01-001
super lightweight



Duplex-Baby Stethoscope 01-002
super lightweight



Anaestophon Stethoscope 01-003
Super Lightweight



Clar Mead Mirror komplett 6 Volt 01-004



Ziegler 01-005
Ø 90mm
with head band without protection cap



01-007
Ø 50mm



Pinard Wooden Stethoscope 01-008
18 cm



Pinard Aluminium Stethoscope 01-009
15 cm



Weber Aesthesiometer 01-010
9 cm



Ziegler 01-006
Ø 90mm
with head band with protection cap



01-011
16cm
01-012
20cm
01-013
25cm

Magill Catheter Intubating Forceps



Magill Catheter Intubating Forcep Gold 01-014
6.5" (2.5" shaft) , Infant , hole (dia 2.00 mm)
01-015
7.5" (3" shaft) , Infant , hole (dia 2.30 mm)
01-016
7.5" (4" shaft) , Infant , hole (dia 2.60 mm)

Magill Catheter Intubating Forcep GOLD 01-017
8" (4" shaft) , Child , hole (dia 3.00 mm)
01-018
8" (4" shaft) , Child , oval tip (5.38 mm X 4.15 mm)
01-019
9" (5" shaft) , Adult , oval (6.80 mm x 5.00 mm)
01-020
10" (5" shaft) , Adult , oval (9.60 mm x 7.70 mm)



PERCUSSION HAMMERS

Perkussionshämmer | Martillos de percusión
 Marteaux-percuteurs | Martelli percussori



Neuro-Duoflex Hammer
01-021 22cm



Dejerine Hammer
01-022 20cm



Dejerine Hammer
01-023 20cm



Troemner Hammer
01-024 145 g
01-025 175 g
01-026 235 g
24.5 cm
spare rubber



Troemner-Simplex Hammer
01-027 21cm



Buck Hammer
01-028 18.5cm



Buck Hammer
01-029 18cm



Taylor Hammer
01-030 18cm
01-031 20cm



Taylor Hammer
01-032 18cm



Babinsky Hammer
01-033 22 cm



Babinsky Hammer
01-034 22 cm



Rabiner Hammer
01-035 25.5 cm
with needle & brush



Berliner Hammer
01-036 20 cm



Traube Hammer
01-037 16 cm



Wartenberg Pinwheel
01-038 19 cm

MC-INTOSH FIBER OPTIC LARYNGOSCOPE BLADE

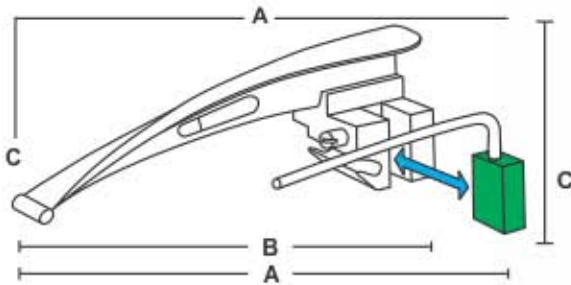

BLADE

Size	A	B	C	Working Length
0	77mm	53mm	14mm	55mm
1	95mm	72mm	43mm	70mm
2	111mm	86mm	44mm	78mm
3	133mm	109mm	44mm	108mm
4	151mm	129mm	44mm	133mm

Mc-Intosh Laryngoscope Fiber Optic

Halogen illumination. Manufactured from AISI 304 Stainless-Steel. Halogen Illumination 2.5 V. The Bulb is inside the handle in order to simplify the sterilization of the blades. All blades and handles are interchangeable with other leading manufacturer. All sets can be combined as per your request, and delivered in Green plastic case.

Blades Availability:

- ★ Matt Finish
- ★ Mirror Finish
- ★ Sand Blast Finish
- ★ Pls, confirm in your order list

Mc-INTOSH FIBER OPTIC LARYNGOSCOPE SET HALOGEN ILLUMINATION

01-039 PEDIATRIC SET

Set of 0,1,2 Blades
Supplied in Green plastic case

01-040 STANDARD SET

Set of 1,2,3 Blades
Supplied in Green plastic case

01-041 ADULT SET

Set of 1,2,3,4 Blades
Supplied in Green plastic case



Laryngoscope Battery
Handle for Adult
C type 2 batteries
01-047



Mc-Intosh Fiber Optic Laryngoscope Set
Halogen Illumination
Manufactured by AISI:
304 Stainless Steel Material



Fig. 0
01-042



Fig. 1
01-043



Fig. 2
01-044

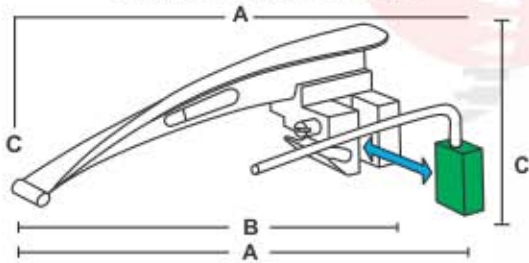

Fig. 3
01-045



Fig. 4
01-046

MC-INTOSH LARYNGOSCOPE



BLADE

Size	A	B	C	Working Length
0	77mm	53mm	14mm	55mm
1	95mm	72mm	43mm	70mm
2	111mm	86mm	44mm	78mm
3	133mm	109mm	44mm	108mm
4	151mm	129mm	44mm	133mm

Fiber Optic Laryngoscope

Plastic case, Halogen illumination. Manufactured from AISI 304 Stainless Steel Halogen Illumination 2.5 V. The Bulb is inside the handle in order to simplify the sterilization of the blades. All blades and handles are interchangeable with other leading manufacturer. All sets can be combined as per your request, and delivered in Green plastic case.

Blades Availability:

- ★ Matt Finish
- ★ Mirror Finish
- ★ Sand Blast Finish
- ★ Pls, confirm in your order list



01-056
Laryngoscope Battery
Handle for Adult
C type 2 Batteries



01-057
Laryngoscope Bulb Small



01-058
Laryngoscope Bulb Large



Fig. 0
01-051



Fig. 1
01-052



Fig. 2
01-053



Fig. 3
01-054

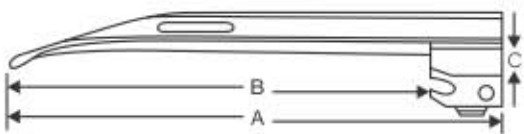

Fig. 4
01-055

Mc-Intosh Laryngoscope Set of Fiber Optic
Halogen Illumination
Manufactured From: AISI 304
Stainless Steel Material

Laryngoskope | Laringoscopios
Laryngoscopes | Laringoscopi

FIBER OPTIC LARYNGOSCOPE MILLER



BLADE

Size	A	B	C	Working Length
0	75mm	53mm	26mm	55mm
1	111mm	80mm	26mm	80mm
2	151mm	134mm	28mm	130mm
3	188mm	167mm	28mm	170mm
4	203mm	180mm	28mm	180mm



01-067
Laryngoscope Battery Handle for Adult
C type 2 Batteries

FIBER OPTIC LARYNGOSCOPE MILLER AVAILABLE SETS WITH BATTERY HANDLE

01-059 PEDIATRIC SET
Set of 0,1,2
Blades
Supplied in Green plastic case

01-060 STANDARD SET
Set of 1,2,3
Blades
Supplied in Green plastic case

01-061 ADULT SET
Set of 1,2,3,4
Blades
Supplied in Green plastic case



MC-INTOSH LARYNGOSCOPE

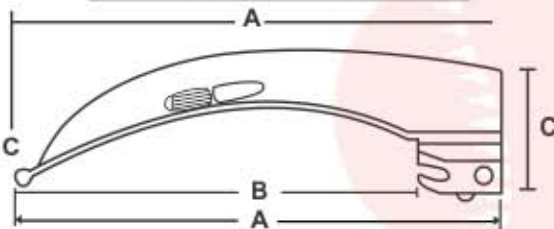

BLADE

Size	A	B	C	Working Length
0	80mm	58mm	30mm	55mm
1	97mm	76mm	36mm	70mm
2	111mm	88mm	36mm	78mm
3	133mm	112mm	36mm	108mm
4	154mm	131mm	38mm	133mm

Mc-Intosh Laryngoscope

Plastic case, Standard illumination. Manufactured from AISI 304 Stainless Steel Matt Type, Standard Illumination 2.5 V. All blades and handles are interchangeable with other leading manufacturer. All sets can be combined as per your request, and delivered in Gray plastic case.

Blades Availability:

- ★ Matt Finish
- ★ Mirror Finish
- ★ Sand Blast Finish
- ★ Pls, confirm in your order list



01-077
With one Spare Bulb



01-076
Laryngoscope Battery Handle for Adult
C type 2 Batteries



Mc-Intosh Laryngoscope Set
Standard Illumination
Manufactured From
Stainless Steel Material

CONVENTIONAL LARYNGOSCOPE SET

Mc-INTOSH LARYNGOSCOPE SET STANDARD ILLUMINATION

AVAILABLE SETS WITH BATTERY HANDLE

01-068 PEDIATRIC SET
Set of 0,1,2 Blades
Supplied in Gray plastic case

01-069 STANDARD SET
Set of 1,2,3 Blades
Supplied in Gray plastic case

01-070 ADULT SET
Set of 1,2,3,4 Blades
Supplied in Gray plastic case



MC-INTOSH LARYNGOSCOPE

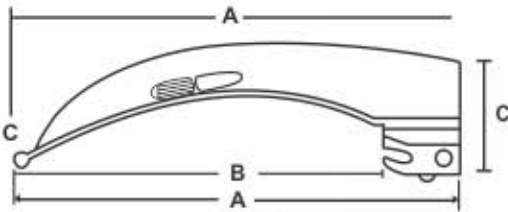

BLADE

Size	A	B	C	Working Length
0	80mm	58mm	30mm	55mm
1	97mm	76mm	36mm	70mm
2	111mm	88mm	36mm	78mm
3	133mm	112mm	36mm	108mm
4	154mm	131mm	38mm	133mm

Mc-Intosh Laryngoscope

Plastic case, Standard illumination. Manufactured from AISI 304 Stainless Steel. All blades and handles are interchangeable with other leading manufacturer. All sets can be combined as per your request, and delivered in Blue plastic case.

Blades Availability:

- * Matt Finish
- * Mirror Finish
- * Sand Blast Finish
- * Pls, confirm in your order list



01-087
With two Spare Bulbs



01-086
Laryngoscope Battery Handle for Adult C type 2 batteries



CONVENTIONAL LARYNGOSCOPE SET

Mc-INTOSH LARYNGOSCOPE CONVENTIONAL STANDARD ILLUMINATION

AVAILABLE SETS WITH BATTERY HANDLE

- 01-078 PEDIATRIC SET**
Set of 0,1,2 Blades.
Supplied in Blue plastic case
- 01-079 STANDARD SET**
Set of 1,2,3 Blades.
Supplied in Blue plastic case
- 01-080 ADULT SET**
Set of 1,2,3,4 Blades.
Supplied in Blue plastic case



Fig. 0
01-081



Fig. 1
01-082



Fig. 2
01-083



Fig. 3
01-084



Fig. 4
01-085

Mc-Intosh Laryngoscope Conventional Standard Illumination
Manufactured From Stainless Steel material

LARYNGOSCOPE MILLER

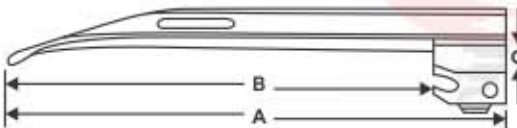

BLADE

Size	A	B	C	Working Length
0	75mm	53mm	26mm	55mm
1	111mm	80mm	26mm	80mm
2	151mm	134mm	28mm	130mm
3	188mm	167mm	28mm	170mm
4	203mm	180mm	28mm	180mm

Mc-Intosh Laryngoscope

Plastic case, Standard illumination. Manufactured from AISI 304 Stainless Steel. All blades and handles are interchangeable with other leading manufacturer. All sets can be combined as per your request, and delivered in Blue plastic case.

Blades Availability:

- * Matt Finish
- * Mirror Finish
- * Sand Blast Finish
- * Pls, confirm in your order list



01-097
With two Spare Bulbs



01-096
Laryngoscope Battery Handle for Adult C type 2 batteries

CONVENTIONAL LARYNGOSCOPE SET

LARYNGOSCOPE SET OF CONVENTIONAL MILLER STANDARD ILLUMINATION

AVAILABLE SETS WITH BATTERY HANDLE

- 01-088 PEDIATRIC SET**
Set of 0,1,2 Blades
Supplied in Blue plastic case
- 01-089 STANDARD SET**
Set of 1,2,3 Blades
Supplied in Blue plastic case
- 01-090 ADULT SET**
Set of 1,2,3,4 Blades
Supplied in Blue plastic case



Fig. 0
01-091



Fig. 1
01-092



Fig. 2
01-093



Fig. 3
01-094



Fig. 4
01-095

Laryngoscope Set of conventional Miller Standard Illumination
Manufactured From Stainless Steel Material



Laryngoskope | Laringoscopios
Laryngoscopes | Laringoscopi

Laryngoscope Flexible (Mc-Coy)



Available blade sizes 2,3 & 4 with 'AA' & 'C' type battery handles
01-100
01-101
01-102

01-098

CONVENTIONAL SET
Flexible Laryngoscope
Conventional
Halogen Illumination
Manufactured From
Stainless Steel High
grade 304 material.

01-099
'C' type handle



Available Blade sizes 2,3 & 4 with 'AA' & 'C' type battery handles

01-105
01-106
01-107

01-103 FIBER OPTIC SET
Flexible Laryngoscope
Set of Fiber Optic

Halogen Illumination
Manufactured From
Stainless Steel High grade 304
material packed in green plastic box.



Laryngoscope Battery
Handle for Adult
AA Batteries
01-104



DIAGNOSTIC PENTOSCOPE SET

01-108
2.5 V Standard illumination for use with 2 batteries type AA.

Consisting:

Universal Handle thread type fit for all Pentoscope Heads like.

- Otoscope Head.
- Ophthalmoscope Head.
- Throat Branch Head.
- Mouth Mirrors Head.

It have two exploring mirrors No. 4 & 5 mm. Its spare 06 disposable Plastic ear Canulas are with sizes 2 x 2.50 mm, 2 x 3.50 mm & 2 x 4.5 mm. On special order it can be as 2 x 1.5 mm for new born babies 2 x 2.5 mm for pediatric and 2 x 4 mm for adults, so it means total 06 canula also available in a plastic tube packing.

Sturdy adjustment mount bracket
2 spare 2.5 V bulb.

Pentoscope set battery handle is operating with two AA size batteries.

This Pentoscope set Packed in our new beautiful Blue Colour plastic case in same blue inner packing material. Spare parts also available of any item.



With 2 spare Bulbs



Mouth Mirrors Head



Otoscope Head



Sturdy Adjustment Mount Bracket



Standard illumination



Plastic ear Canulas



Handle



Two laryngeal mirrors: n. 4 and 5



Bent-arm illuminator:
pin contact fitting.



Specula



With 2 spare Bulbs

**Professional Otoscope & Ophthalmology Set
ENT Medical Diagnostic Set
01-109**

2.5 V Standard illumination for use with 2 batteries C type.

Including:

Otoscope Head: Luir Lock fitting.

Chrome plated.

Fix lens 4 x in plastic mount can be removed for introduction of instruments.

Specula sizes: 2.5, 3.5 & 4.5 mm Included,

Ophthalmoscope head: Luir Lock fitting.

Lens selection wheel permits choice of corrective lenses from 0 to - 20 and 0 to +20 diopters.

Single large circle aperture.

Bent-arm illuminator: pin contact fitting.

Nasal speculum: Chrome plated.

Two laryngeal mirrors: n. 4 and 5.

Battery handle: 28mm. For 2 cell C-batteries.

Chrome plated. For adjustment of all illumination.

Replacement bulb: 2.5 V

Diagnostic set is supplied in our new beautiful look and quality Blue Case, which protect our quality Products from moisturizing and damaging.



Otoscope Head



Nasal speculum: Chrome plated.



Ophthalmoscope head



ENT Specula

Diagnostik-Bestestecke
Trousse à diagnose

Juegos para diagnóstico
Astucci diagnostici



Two laryngeal mirrors: n. 4 and 5



Bent-arm illuminator: pin contact fitting.

**Universal Otoscope & Ophthalmology Set
ENT Medical Diagnostic Set
01-110**

2.5 V Standard illumination for use with 2 batteries type C.

Including:

Otoscope Head: Luir Lock fitting. Chrome plated.

Fix lens 4 x in plastic mount can be removed for introduction of instruments.

Specula sizes: 2.5, 3.5 & 4.5 mm Included,

Ophthalmoscope head: pin contact fitting.

Lens selection wheel permits choice of corrective lenses from 0 to - 20 and 0 to +20 diopters.

Single large circle aperture.

Bent-arm illuminator: Luir Lock fitting.

Nasal speculum: Chrome plated.

Two laryngeal mirrors: n. 4 and 5.

Battery handle: 28mm. For 2 cell C-batteries.

Chrome plated. For adjustment of all illumination.

Replacement bulb: 2.5 V

The Diagnostic set is supplied in new beautiful look and quality Blue Case, which protect our quality Products from moisturizing and damaging.

MANZIM
SURGICO



Nasal speculum: Chrome plated.



ENT Specula



Otoscope Head



Ophthalmoscope Head



Handle



Standard Otoscope + Ophthalmoscope Set
01-111

This Set is with 2.5 V standard illumination, handle is chrome plated as well otoscope head too. Handle and head is Luir / Faster lock fitting. Head of otoscope is with 6x magnifying glass. 03 Resuable speculas with sizes 2.5, 3.5 & 4.5 mm. A Full Functional Ophthalmoscope compact durable, light weight. Standard bulb and precision system 4 different apertures selection range of lenses -20 to +20 bright white light and brilliant image A Full Functional Ophthalmoscope Battery handle for 2 'c' batteries. Rheostat for adjustment of illumination. Supply in Black Plastic Box Packing.



Otoscope Head



ENT Specula



Ophthalmoscope head



ENT Specula



'C' type Battery handle



Standard Ophthalmoscope Set
01-112

A Full Functional Ophthalmoscope compact durable, light weight. Standard bulb and precision system 4 different apertures selection range of lenses -20 to +20 bright white light and brilliant image Packed in Black Plastic Case.

MANZIM
SURGICO



Standard Otoscope Set
01-113

this otoscope is with 2.5 V standard illumination, handle is chrome plated as well otoscope head too. Handle and head is Luir / Faster lock fitting. Head of otoscope is with 6x magnifying glass. 03 Resuable speculas with sizes 2.5, 3.5 & 4.5 mm. Battery handle for 2 'c' batteries. Rheostat for adjustment of illumination. Supply in Black Pouch Packing



Ophthalmoscope head



'C' type Battery Handle

Diagnostik-Bestestecke
Trousse à diagnose

Juegos para diagnóstico
Astucci diagnostici



**Standard Oscope Set
01-114**

this otoscope is with 2.5 V standard illumination, handle is chrome plated as well otoscope head too. Handle and head is Luir / Faster lock fitting. Head of otoscope is with 6x magnifying glass. 03 Reusable speculas with sizes 2.5, 3.5 & 4.5 mm. Battery handle for 2 'c' batteries. Rheostat for adjustment of illumination. Supply in Black Pouch Packing



**Otoscope + Ophthalmoscope Set
01-115**

This otoscope is with 2.5 V standard illumination, handle is chrome plated as well otoscope head too. Handle and head is Luir / Faster lock fitting. Head of otoscope is with 6x magnifying glass. 03 Reusable speculas with sizes 2.5, 3.5 & 4.5 mm. A Full Functional Ophthalmoscope compact durable, light weight. Standard bulb and precision system 4 different apertures selection range of lenses -20 to +20 bright white light and brilliant image A Full Functional Ophthalmoscope Battery handle for 2 'c' batteries. Rheostat for adjustment of illumination. Supply in Black Pouch Packing.



**Standard Ophthalmoscope
01-116**

A Full Functional Ophthalmoscope. compact durable, Standard bulb and precision system 4 different apertures selection range of lenses -20 to +20 bright white light and brilliant image Handle made of Stainless Steel Material.



**Mini Ophthalmoscope
01-117**

A Full Functional Ophthalmoscope. compact durable, light weight. Standard bulb and precision system 4 different apertures selection range of lenses -20 to +20 bright white light and brilliant image Made of plastic Material.

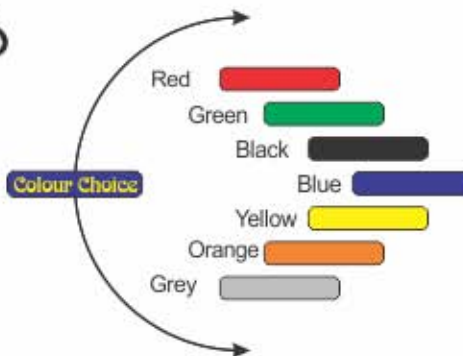

**Mini Ophthalmoscope
01-118**

A Full Functional Ophthalmoscope. compact durable, light weight. Standard bulb and precision system 4 different apertures selection range of lenses -20 to +20 bright white light and brilliant image made of plastic Material.

01-119

Dissecting Set of 6 pcs.

- Dropper Oil
- Probe Plastic Handle
- Dressing Forceps
- Dressing Scissors S/s
- Hook
- Scalpel Handle 4

01-120

Dissecting Set of 12 pcs.

- Iris Scissors
- Scalpel Knives 4
- Probe Single Ended
- Scalpel Handle 3
- Dressing Scissors S/s
- Dressing Scissors S/b
- Dressing Forceps
- College Tweezer
- Probe Straight Plastic Handle
- Probe Angular Plastic Handle
- Dropper Owl
- Hook

01-121
New Instructor's Dissecting set

Contain quality stainless steel Instrument Enclosed in an attractive zippered case Scissor surgical 4 1/2" scissiors fine point 4 1/2" Forceps fine point Str . Forcep fine point Cvd . Mosquito forceps Cvd 5" box lock . One piece scalpel 1 1/2" blade Surgeon handle # 4 . Mall probe and seeker 2 plastic handle str needle also 2 blade # 22 for each set.

01-122
Dissecting Set-Advanced

Stainless steel, consisting of 12 instruments for accurate dissection. Supplied in zipper leather case.

Kit consists of:

- Scissors - 2 pcs. Forceps - 2 pcs. Needle - 2 pcs.
- Artery Forceps - 1 pc. Tissue Forceps - 1 pc.
- Seeker - 1 pc. Scalpel Handle w/ Blade - 1 pc.
- Bone Cutter - 1 pc. Dental Probe & Seeker - 1 pc

01-123
Dissecting Kit

Kit includes:

- 1 4 1/2" Dissecting forceps with curved and serrated tips
- 1 Curved dissecting needle 1 Glass pipette with rubber bulb
- 1 4 1/2" Dissecting forceps straight and serrated tips
- 1 Dissecting scalpel, 6" long, 1 1/2" cutting edge.
- 1 4 1/2" Dissecting scissors, sharp, straight points
- 1 Plastic ruler 6", 1/16" div., millimeter and centimeter

01-124
Dissecting Set - Pro

Stainless steel, consisting of 20 instruments for accurate dissection. Supplied in zipper leather case.

Kit consists of:

- Scissors - 2 pcs. Forceps - 2 pcs. Needles - 4 pcs. Scalpel - 1 pc.
- B.P. Handle w/ Blade - 1 pc. Razor - 1 pc. Ruler 6" - 1 pc.
- Magnifying Glass - 1 pc. Glass Slide - 1 pc. Chain and Hook - 1 pc.
- Cover Slips - 1 pc. Blow Pipe - 1 pc. Needle Wooden Handle - 1 pc.
- Dropper Glass - 1 pc. Brush - 1 pc.

01-125
Dissecting Set - Popular

Stainless steel, consisting of 14 instruments for accurate dissection. Complete in zipper leather case.

Kit consists of:

- Scissors - 2 pcs. Forceps - 2 pcs. Needles - 4 pcs. Scalpel - 1 pc.
- B.P. Handle w/ Blade - 1 pc. Razor - 1 pc. Magnifying Glass - 1 pc.
- Chain and Hook - 1 pc. Blow Pipe - 1 pc.

01-126
Dissecting Set - Senior

Stainless steel, consisting of 9 instruments for accurate dissection. Supplied in zipper leather case.

Kit consists of:

- Scissors - 2 pcs. Forceps - 2 pcs. Needle - 2 pcs. Scalpel - 1 pc.
- Scalpel Handle w/ Blade - 1 pc. Ruler 6" - 1 pc.

Diagnostik-bestecke
Estuches de diagnostico

Diagnostic Setts
Combinazioni per diagnostica



01-127
Dissecting Set



01-128
Dissecting Set



01-129
Dissecting Set



01-130
Dissecting Set



01-131
Dissecting Set



01-132
Dissecting Set



Jameson Caliper
01-133 8 cm



Townley Caliper
01-134 10 cm



Vernier Caliper
01-135 15 cm



Vernier Caliper
01-136 15 cm



Carroll Pocket Goniometer
01-137 14.5cm



Möeltgen Flexometer
01-138 24cm

Bertillon Measuring Device
01-139 32 cm



Castroviejo-Epker Caliper
01-140 18 cm
Measuring range 40 mm, straight



Castroviejo-Epker Caliper
01-141 18 cm Angled
Measuring range 40 mm



Castroviejo Bone Caliper Straight
01-142 18cm



Castroviejo Bone Caliper Curved
01-143 18cm



Castroviejo-Epker Caliper
01-144 9 cm Str.
Measuring range, 40 mm
01-145 9 cm Cvd.
Measuring range, 40 mm



Castroviejo Eye View Caliper
01-146 8 cm, Str.
Measuring range, 20 mm
01-147 8 cm, Cvd.
Measuring range, 20 mm



Castroviejo Eye View Caliper
01-148 8 cm
Measuring range 20 mm



Tonometer
01-149 Set



TROCARS, SUCTION TUBES, NEEDLE AND PROBES





Cap Only



Fig. 1 02-03 1.7 mm Ø
Fig. 2 02-04 3 mm Ø
Fig. 3 02-05 4.5 mm Ø
Fig. 4 02-06 6 mm Ø



Fig. 1 02-09 1.7 mm Ø
Fig. 2 02-10 3 mm Ø
Fig. 3 02-11 4.5 mm Ø
Fig. 4 02-12 6 mm Ø

Universal Abdominal Trocar Set 02-01
(Handle with 4 needles) 14 cm
Fig. 1.7 mm Ø to 6 mm Ø
02-02
Only Handle

Universal Abdominal Trocar Set 02-07
(Handle with 4 needles) 14 cm
Fig. 1.7 mm Ø to 6 mm Ø
02-08
Only Handle



Luer, Trocar 02-13
Luer Lock Adapter

Uckermann Trocar 02-14 13cm

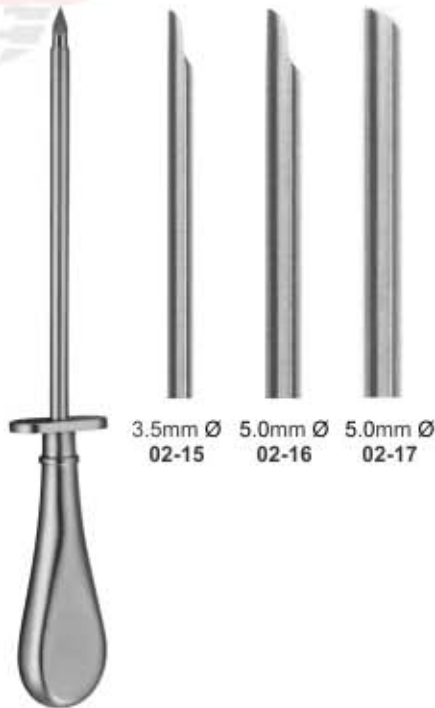

Sinuscopy Trocar 17cm

3.5mm Ø 02-15
5.0mm Ø 02-16
5.0mm Ø 02-17



Nelson Trocar Thorax 02-20 21cm

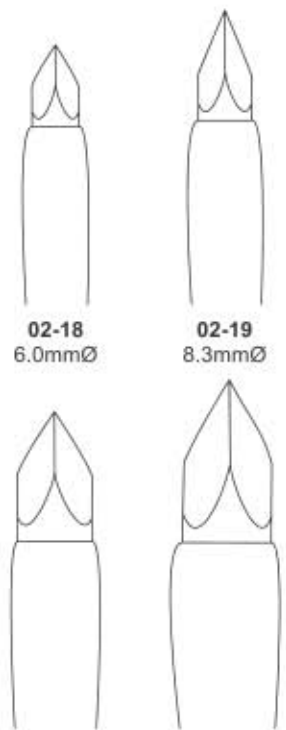

02-18 6.0mmØ

02-19 8.3mmØ

02-20 9.5mmØ

02-21 11.6mmØ

Trokare | Trócares
Trocarts | Tre quarti

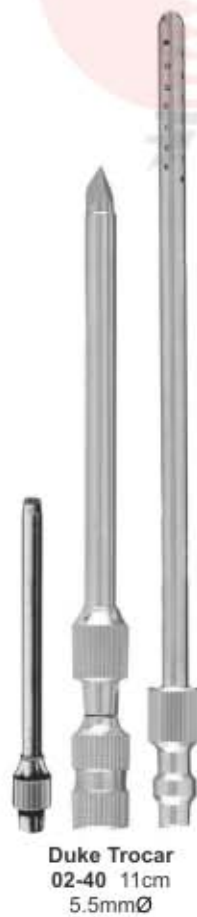
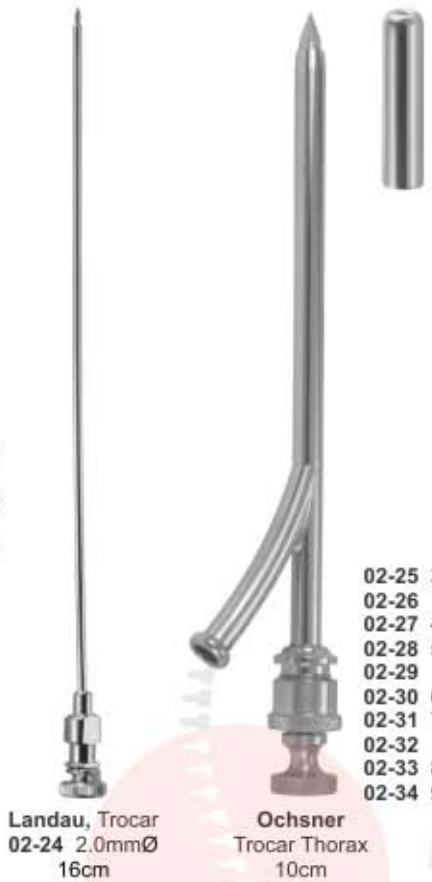

Trokare | Trócares
Trocart | Trequarti



Buelau, Trocar
02-45 8 mm
24 cm



Fleurant Trocar
02-46 23cm
5 mm Ø



Fleurant Trocar
02-47 23cm
5 mm Ø



Fleurant Trocar
02-48 23cm
5 mm Ø



Pool
02-49 22.5 cm
Suction cannula with
outer tube to be screwed

SUCTION TUBES

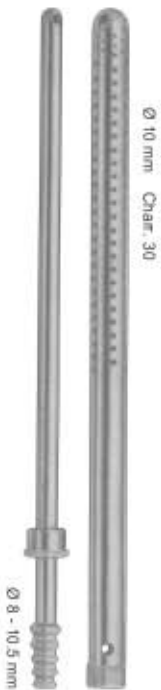

Pool
02-50 22.5 cm
Suction cannula with
outer tube to be screwed



02-51 18 cm
for tonsillectomy,
oral and laryngeal
operations



02-52 22 cm
Suction Cannula for
tonsillectomy, oral
and laryngeal operations

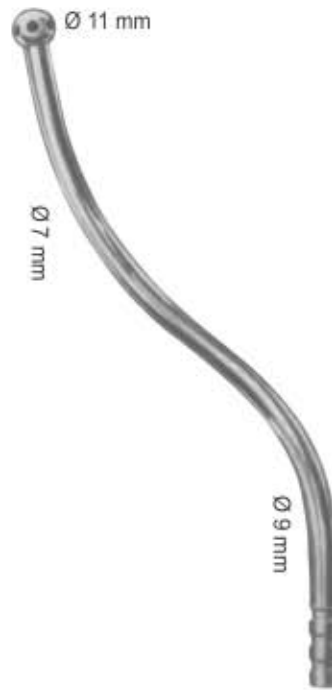

02-53 18 cm
suction cannula for
tonsillectomy, oral
and laryngeal operations



02-54 17 cm
S-shaped blunt cannula
for aspirating fluid from
the excretory ducts of
large glands and for
keeping the operations
area clear

Saugrohre | Tubos de aspiracion
 Canules d'aspiration | Tubi per aspirazione

				
<p>Cooley, Suction Tube 02-55 18 cm 6mm Ø</p>	<p>Cooley, Suction Tube 02-56 18 cm 7mm Ø</p>	<p>Cooley, Suction Tube 02-57 18 cm 09mm Ø</p>	<p>Cooley, Suction Tube 02-58 32.7 cm 9mm Ø Curved</p>	<p>Andrews-Pynchon Suction Tube 02-59 23.5 cm</p>
				
<p>Yankauer Suction Tube 02-62 31 cm, 15 cm 2.5 cm, 10 cm</p>	<p>Yankauer Suction Tube 02-63 31 cm, 15 cm 2.5 cm, 10 cm</p>	<p>De Bakey suction tube 02-64 27.5 cm</p>	<p>Yankauer Suction Tube 02-65 27 cm Baby Yankauer 02-66 21 cm</p>	<p>Coupland Suction Tube 02-67</p> <p>Byrd, Suction Tube 02-68 1.5 mm 02-69 2.5mm 02-70 3.5 mm</p>
				
<p>Adson suction tubes 02-71 4 mm Ø 15 cm</p> <p>Adson suction tubes 21 cm 02-72 4 mm Ø 12 Charr./Fr 02-73 5 mm Ø 15 Charr./Fr</p>	<p>02-74 Wullstein Suction Tube Complete</p>	<p>Gorney Suction Tubes 02-75 18 cm suction dissector</p>	<p>Landolt Dissecting Suction Tubes 02-76 4 mm wide 02-77 5 mm wide 20 cm suction raspatories, sharp,</p>	<p>Lopez-Reinke Suction Tubes 02-78 23.5 cm tonsil dissector with suction device</p>

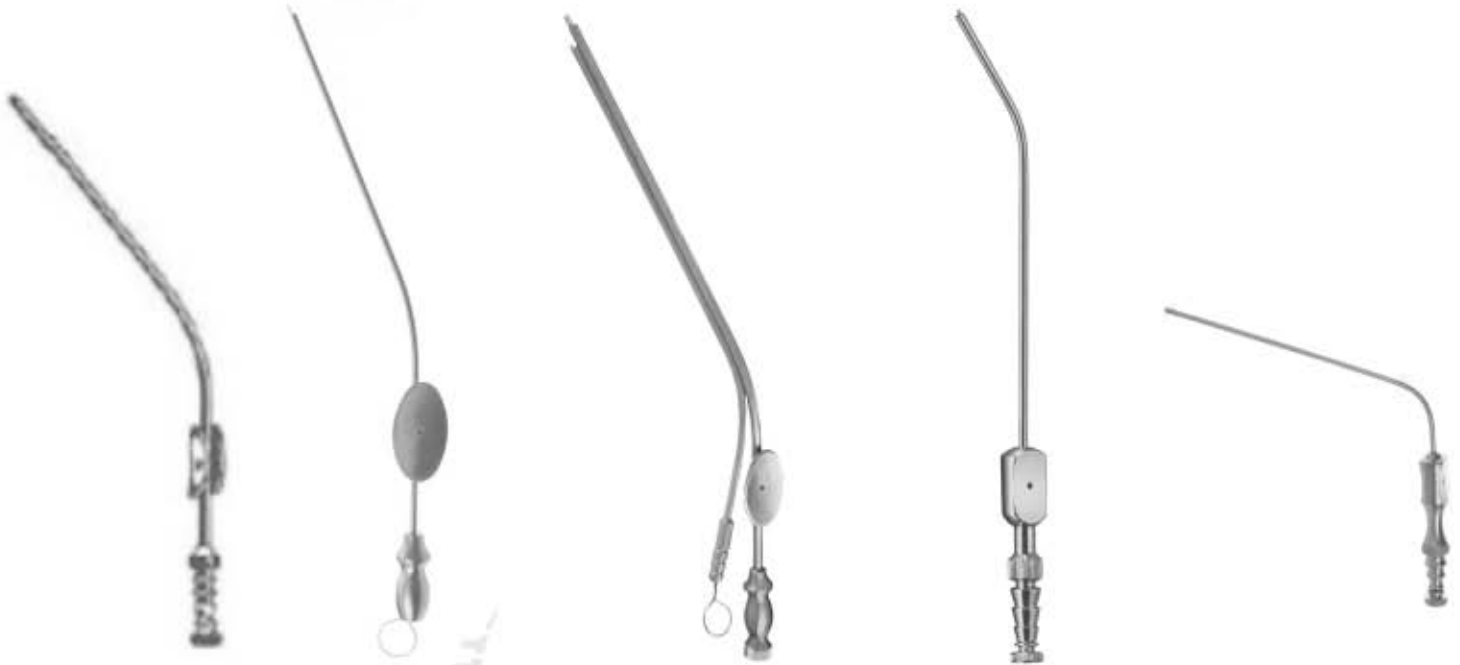

Plester Daumenplatt
 02-79 6 Charr./Fr.
 02-80 7 Charr./Fr.
 02-81 8 Charr./Fr.
 02-82 9 Charr./Fr.
 02-83 10 Charr./Fr.
 02-84 11 Charr./Fr.
 02-85 12 Charr./Fr.
 02-86 15 Charr./Fr.

Baron suction tubes 7.5 cm
 02-87 1 mm Ø 3 Charr./Fr.
 02-88 1 2/3 mm Ø 5 Charr./Fr.
 02-89 2 1/3 mm Ø 7 Charr./Fr.

Baron suction tubes 10 cm
 02-90 1 mm Ø 3 Charr./Fr.
 02-91 1 2/3 mm Ø 5 Charr./Fr.
 02-92 2 1/3 mm Ø 7 Charr./Fr.

House suction tubes 7.5 cm
 02-93 1 mm Ø 3 Charr./Fr.
 02-94 1 2/3 mm Ø 5 Charr./Fr.
 02-95 2 1/3 mm Ø 7 Charr./Fr.
 02-96 2 2/3 mm Ø 8 Charr./Fr.
 02-97 3 1/3 mm Ø 10 Charr./Fr.
 02-98 4 mm Ø 12 Charr./Fr.
 02-99 4 2/3 mm Ø 14 Charr./Fr.

House suction tubes 10 cm
 02-100 1 mm Ø 3 Charr./Fr.
 02-101 1 2/3 mm Ø 5 Charr./Fr.
 02-102 2 1/3 mm Ø 7 Charr./Fr.
 02-103 2 2/3 mm Ø 8 Charr./Fr.
 02-104 3 1/3 mm Ø 10 Charr./Fr.
 02-105 4 mm Ø 12 Charr./Fr.
 02-106 4 2/3 mm Ø 14 Charr./Fr.

Plester Suction Tubes 17 cm
 02-107 2.0 mm Ø 6 Charr./Fr.
 02-108 2.3 mm Ø 7 Charr./Fr.
 02-109 2.5 mm Ø 8 Charr./Fr.
 02-110 3.0 mm Ø 9 Charr./Fr.
 02-111 3.3 mm Ø 10 Charr./Fr.
 02-112 3.5 mm Ø 11 Charr./Fr.
 02-113 4.5 mm Ø 12 Charr./Fr.
 02-114 5.0 mm Ø 15 Charr./Fr.

Fergusson Suction Tubes 17 cm
 02-115 2.0 mm Ø 6 Charr./Fr.
 02-116 2.3 mm Ø 7 Charr./Fr.
 02-117 2.5 mm Ø 8 Charr./Fr.
 02-118 3.0 mm Ø 9 Charr./Fr.
 02-119 3.3 mm Ø 10 Charr./Fr.
 02-120 3.5 mm Ø 11 Charr./Fr.
 02-121 4.5 mm Ø 12 Charr./Fr.
 02-122 5.0 mm Ø 15 Charr./Fr.



FRAZIER
 suction tubes
 02-123 6 Fr.
 02-124 7 Fr.
 02-125 8 Fr.
 02-126 9 Fr.
 02-127 10 Fr.
 02-128 11 Fr.
 02-129 12 Fr.
 02-130 13 Fr.
 02-131 15 Fr.
 19 cm



FRAZIER 30°
 suction tubes
 02-132 6 Fr.
 02-133 7 Fr.
 02-134 8 Fr.
 02-135 9 Fr.
 02-136 10 Fr.
 02-137 11 Fr.
 02-138 12 Fr.
 02-139 13 Fr.
 02-140 15 Fr.
 18 cm



FRAZIER 45°
 suction tubes
 02-141 6 Fr.
 02-142 7 Fr.
 02-143 8 Fr.
 02-144 9 Fr.
 02-145 10 Fr.
 02-146 11 Fr.
 02-147 12 Fr.
 18 cm

Cannula

- 02-148 ○ 6fr
- 02-149 ○ 7fr
- 02-150 ○ 8fr
- 02-151 ○ 9fr
- 02-152 ○ 10fr
- 02-153 ○ 11fr
- 02-154 ○ 12fr
- 02-155 ○ 13fr
- 02-156 ○ 14fr



SUCTION AND IRRIGATION CANNULAS

Saug-und Spülkanülen | Canulas para aspiracion y lavado
 Canules pour aspiration | Cannule per aspirazione e lavaggio



Luer
02-157
 Suction Tube working
 length 110 mm



Nasal Suction Tubes
02-158 Ø 4.5 mm
02-159 Ø 5.5 mm
 17.5 cm



Eicken
Suction &
Irrigation Cannula
02-160 2.5 mm Ø
02-161 3.0 mm Ø
 Slightly curved



Eicken
Suction &
Irrigation Cannula
02-162 2.5 mm Ø
02-163 3.0 mm Ø
 Strongly curved



Tonsil Needle
Suction &
Irrigation Cannula
02-164 0.8 mm Ø
 Straight



Tonsil Needle
Suction &
Irrigation Cannula
02-165 0.8 mm Ø
 Curved



Septum Needle
Suction &
Irrigation Cannula
02-166 0.8 mm Ø
 bayonet



Septum Needle
Suction &
Irrigation Cannula
02-167 0.8 mm Ø
 angled on flat



Luer-Lock Suction &
Irrigation Cannula
02-168 3.0 mm Ø



Luer-Lock Suction &
Irrigation Cannula
02-169 2.5 mm Ø



Fisch Suction &
Irrigation Cannula
02-170 4.0 mm Ø



Probe, Double Ended

- 1.0 mm Ø
- 02-171** 11.5cm
- 02-172** 13.0cm
- 02-173** 14.5cm
- 02-174** 16.0cm
- 02-175** 18.0cm
- 02-176** 20.0cm
- 02-177** 25.0cm

Probe, Double Ended

- 1.5 mm Ø
- 02-178** 11.5cm
- 02-179** 13.0cm
- 02-180** 14.5cm
- 02-181** 16.0cm
- 02-182** 18.0cm
- 02-183** 20.0cm
- 02-184** 25.0cm

Probe, Double Ended

- 2.0 mm Ø
- 02-185** 11.5cm
- 02-186** 13.0cm
- 02-187** 14.5cm
- 02-188** 16.0cm
- 02-189** 18.0cm
- 02-190** 20.0cm
- 02-191** 25.0cm

Probe With Eye

- 2.0mm Ø
 - 02-192** 11.5cm
 - 02-193** 13.0cm
 - 02-194** 14.5cm
 - 02-195** 16.0cm
 - 02-196** 18.0cm
 - 02-197** 20.0cm
 - 02-198** 25.0cm
- with eyelet

Probe

- 2.0mm Ø
 - 02-199** 11.5cm
 - 02-200** 13.0cm
 - 02-201** 14.5cm
 - 02-202** 16.0cm
- myrtle-shaped

Ohrkatheter
Sondes auriculaires

Sondas auriculares
Sonde auricolari



Hartmann, Eustachian Catheters
Fig. 1
02-203 2.0 mm Ø
02-204 2.5 mm Ø
02-205 3.0 mm Ø

Hartmann Eustachian Catheters
Fig. 2
02-206 2.0 mm Ø
02-207 2.5 mm Ø
02-208 3.0 mm Ø

Killian, Eustachian Catheters
02-209 16 cm 2.5 mm Ø
02-210 16 cm 3.0 mm Ø oval opening

Hartmann Eustachian Catheters
15cm



Trötsch Eustachian Catheters 15cm

Zöllner, Suction Tube
02-223 0.7mm Ø complete with 1 slip-on cannula, 0.7mm Ø



Iowa, Suction Tube
02-224 0.7mm Ø 16cm



Rosen Suction Tube
X=80 mm
02-225 0.7mm Ø
02-226 0.9mm Ø
02-227 1.2mm Ø



ROSEN, Suction Tube
X=65 mm
02-228 0.7mm Ø
02-229 0.9mm Ø
02-230 1.2mm Ø



Magill Suction Tube
24.5cm
02-231 3.0mm Ø
02-232 3.5mm Ø
02-233 4.0mm Ø



Suction Tube, Guide Needle
19.5cm
02-234 2.2/3mmØ 8 Charr./Fr.
02-235 3.1/3mmØ 10 Charr./Fr.
02-236 4mmØ 12 Charr./Fr.
02-237 4 2/3mmØ 14 Charr./Fr.
02-238 5 1/3mmØ 16 Charr./Fr.
02-239 6mmØ 18 Charr./Fr.



Suction Tube, Guide Needle
19.5cm
02-240 2mmØ 6 Charr./Fr.
02-241 2.2/3mmØ 8 Charr./Fr.
02-242 3 1/3mmØ 10 Charr./Fr.
02-243 4mmØ 12 Charr./Fr.
02-244 4 2/3mmØ 14 Charr./Fr.
02-245 5 1/3mmØ 16 Charr./Fr.
02-246 6 1/3mmØ 18 Charr./Fr.



Suction Tube, Guide Needle
Lancet Tip 19.5cm
02-247 2.2/3mmØ 8 Charr./Fr.
02-248 3.1/3mmØ 10 Charr./Fr.
02-249 4mmØ 12 Charr./Fr.
02-250 4 2/3mmØ 14 Charr./Fr.
02-251 5 1/3mmØ 16 Charr./Fr.
02-252 6mmØ 18 Charr./Fr.

Sonden | Sondas y estiletos
 Sondes et stylets | Specilli e sonde

**Butterfly Grooved Director
 With Tongue Tie Plain End**

- 02-253 11.5cm
- 02-254 13.0cm
- 02-255 14.5cm
- 02-256 16.0cm
- 02-257 18.0cm
- 02-258 20.0cm



**Butterfly Grooved Director
 With Tongue Tie Plain End**

- 02-259 11.5cm
- 02-260 13.0cm
- 02-261 14.5cm
- 02-262 16.0cm
- 02-263 18.0cm
- 02-264 20.0cm



**Doyen
 Probes &
 Directors
 02-265
 14cm**



**Nélaton
 Probes &
 Directors
 02-266
 16cm**



**Directors
 02-267 13cm
 02-268 14.5cm
 02-269 16cm
 Larry Probe
 and Grooved
 Director,
 17.8 cm**



**Doyen
 02-270
 14.5cm**



**Nélaton
 02-271
 16cm**



**Director Probe
 End
 02-272 14cm
 Director with tip
 Diam. of tip
 3.3 mm**



**Brodie
 02-273 20cm
 Director with
 tip Diam. of
 tip 3.5 mm**



**Lockhart-
 Mummery
 02-274
 16.5cm**



**Lockhart-
 Mummery
 02-275
 16.5cm**



**Lockhart-
 Mummery
 02-276
 16.5cm**

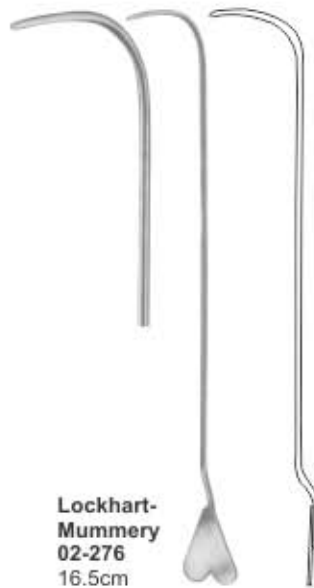

**Lockhart-
 Mummery
 02-277
 16.5cm**

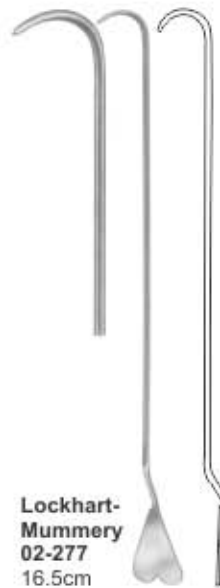

**Director
 with wire
 loop,
 malleable
 02-278
 19cm**



COTTON APPLICATORS



Jopson-Horne
Cotton Applicator
02-279 18cm



Fein Cotton
Applicator
02-280 28cm



Pelteson Cotton
Applicator
02-281 23cm



Barr Fistula Probe
02-282
with 20.3cm sterling shaft,
eye at tip, 29.2cm overall



Barr Crypt Hook
02-283
25.4cm short and long
hook ends



Buie Suction Tube
02-284
45 cm with finger
valve, 15 Fr. (5 mm)

Bowman Lacrimal Probes Double Ended, Sterling Silver



02-285
Bowman Probe,
000-0000



02-286
Bowman Probe,
00-0



02-287
Bowman Probe,
1-2



02-288
Bowman Probe,
3-4



02-289
Bowman Probe,
5-6



02-290
Bowman Probe,
7-8

William Lacrimal Probes Double Ended, Sterling Silver



02-291
William Probe,
000-0000



02-292
William Probe,
00-0



02-293
William Probe,
1-2



02-294
William Probe,
3-4



02-295
William Probe,
5-6



02-296
William Probe,
7-8

Sonden | Sondas y estiletas
Sondes et stylets | Specilli e sonde

								
Biolvar 02-297 15cm 02-298 18cm 02-299 20cm	Desjardim 02-300 18cm (Set 3 Pieces)	Probes With Eye 02-301 14.5cm 02-302 16.0cm 02-303 20.0cm	Myrtle Leaf Probe 02-304 14.5cm	Myrtle Leaf Probe 02-305 13.0cm 02-306 14.5cm 02-307 16.0cm 02-308 18.5cm 02-309 20.0cm	Probe 02-310	Wilder Lacrimal Dilator 02-311 10cm medium taper	02-312 19cm Double ended probe, malleable, diam, of tips 3 mm with hole	
								
02-313 25cm 02-314 30cm Double ended probes, tin, malleable, diam, of tips 3.5 mm with hole	02-315 40cm Double ended probes, tin, malleable, diam, of tips 4 mm with hole	02-316 1.5 mm 02-317 2.0 mm 02-318 2.5 mm 30cm	Clips Mayo 02-319 14cm	Stacke 02-320 10cm	Killian 02-321 16.5cm	02-322 16.5cm	Seiffert 02-323 18cm	
								
Modell Piccolo 02-324 11cm Round Serrated	Modell Piccolo 02-325 11cm Triangular Serrated end	Farrell 02-326 11cm Round Serrated end	Lathbury-Farrel 02-327 11cm Triangular Serrated end	Spatula 02-328 14.5cm	Spatula 02-329 14.5cm			

SCALPEL HANDLE, SCALPEL BLADES, DISSECTING KNIVES & SAWS



Skalpelligriffe
Mangos de bisturías

Manches pour bistouris
Manici per bisturi



03-01
#3 Scalpel Handle
12.50 cm
Blade Size 10, 11,
12, 13, 15, 17



03-02
#3 Scalpel Handle/
Graduated 12.75 cm
Blade Size 10, 11,
12, 13, 15, 17



03-03
Scalpel Handle
#4 Graduated
with scale



03-04
#4 Scalpel Handle
12.75 cm Blade
Size 18, 20, 21, 22,
23, 24, 25, 60,70



03-05
#4 Scalpel Handle/
Graduated 12.75 cm
Blade Size 18, 20, 21,
22, 23, 24, 25, 60,70



03-06
4LA Scalpel Handle
21 cm Blade
Size 18, 20, 21, 22,
23, 24, 25, 60,70



03-07
#3, #4 Scalpel
Handle
Double Ended
16 cm



03-08
Scalpel Handle
3L Long 21 cm
Blade Size
10, 11, 12, 15, 17



03-09
#7 Scalpel
Handle
16.5 cm
Blade 10, 11,
12, 13, 15, 17



03-10
Fig. 10 - 17
12.5cm
Solid



03-11
Scalpel Handle
4L Long 21 cm
Blade
Size 18, 20, 21,
22, 23, 24, 25,
60,70



03-12
#3LA Scalpel
Handle / Long
Angled 20.25 cm
Blade Size
10, 11, 12, 15, 17



03-13
Knife Handle
(Smooth) for
Blades Nos.
60 and 70

SCALPEL HANDLES

Skalpelli
Mangos de bisturíes

Manches pour bistouris
Manici per bisturi



03-14
Siegel Round Scalpel Handle #3 With Adjustable Tip 16 cm
Blade Size 10, 11, 12, 13, 15, 17

03-15
Siegel Round Scalpel Handle #4 With Adjustable Tip 16 cm
Blade Size 18, 20, 21, 22, 23, 24, 25, 60, 70

03-16
Round Knurled Scalpel Handle 11.5 cm
Blade Size 50, 60 & 70

03-17
Round Knurled Scalpel Handle 12.7 cm
Blade Size 50, 60 & 70

03-18
Round Knurled Scalpel Handle 12.7 cm
Blade Size 50, 60 & 70

03-19
Round Knurled Scalpel Handle 11 cm
Blade Size 50, 60 & 70

03-20
Round Knurled Scalpel Handle 13.5 cm
Blade Size 50, 60 & 70

03-21
Beaver Handle



03-22
Round Knurled Scalpel Handle 12 cm

03-23
#3RK Kaye Round Scalpel Handle 15 cm, Blade Size 10, 11, 12, 13, 15, 17

03-24
#3R Corwin Round Scalpel Handle 14.5 cm
Blade Size 10, 11, 12, 15, 17

03-25
#4R Corwin Round Scalpel Handle, 14.5 cm
Blade Size 18, 20, 21, 22, 23, 24, 25, 60, 70

03-26
#3RC Scalpel Handle 14 cm, Blade Size 10, 11, 12, 13, 15, 17

03-27
#3P Scalpel Handle 15.5 cm, Blade Size 10, 11, 12, 13, 15, 17

03-28
15.5cm Blade Size 10 - 17
With Round Hollow Handle

03-29
Scalpel Handle

03-30
Scalpel Grip

SCALPEL HANDLES, BLADE BREAKERS

Skalpgriffe, Klingenbrecher

Mangos de bisturí, rompe cuchillas

Poignées de scalpel, disjoncteurs de lame

Manici per bisturi, rompitrama



03-31
Round Scalpel Handle, Double Head #3, Blade Size 10, 11, 12, 13, 15, 17



03-32
Bever Handle



03-33
Scalpel Plastic Handle #8 Blade Size 18, 20, 21, 22, 23, 24, 25, 60,70



03-34
Collin Scalpel Handle #9 Blade Size 10, 11, 12, 13, 15, 17



Fig. 10



Fig. 11

Blade Sizes



Fig. 12



Fig. 15



03-35
Scalpel Plastic Handle



03-36
Scalpel Plastic Handle #5 Blade Size 10, 11, 12, 13, 15, 17



03-37
Scalpel Plastic Handle #6 Blade Size 18, 20, 21, 22, 23, 24, 25, 60,70



Fig. 20



Fig. 22

RAZOR BLADE HOLDER & BREAKERS



03-38
Cole-Parmer Dissecting Blade Remover For Blade Handle



03-39
Troutman-Chris Blade Breaker & Holder with Push-Pull Lock 9 cm



03-40
Troutman-Chris Blade Breaker & Holder angled, with Push-Pull Lock 9 cm



03-41
Blade Holder Blade Breaker & Holder, with Ratchet Lock 11 cm



03-42
Castroviejo Blade Breaker & Holder, with Push-Pull Lock 13 cm



03-43
Razor Blade Breaker & Holder, Straight 18.5 cm



03-44
Sterile Scalpel
Blade Size # 6
Stainless Steel



03-45
Sterile Scalpel
Blade Size # 10
Stainless Steel



03-46
Sterile Scalpel
Blade Size # 10A
Stainless Steel



03-47
Sterile Scalpel
Blade Size # 11
Stainless Steel



03-48
Sterile Scalpel
Blade Size # 11P
Stainless Steel



03-49
Sterile Scalpel
Blade Size # E11
Stainless Steel



03-50
Sterile Scalpel
Blade Size # 12
Stainless Steel



03-51
Sterile Scalpel
Blade Size # 13
Stainless Steel



03-52
Sterile Scalpel
Blade Size # 15
Stainless Steel



03-53
Sterile Scalpel
Blade Size # 15A
Stainless Steel



03-54
Sterile Scalpel
Blade Size # 17
Stainless Steel



03-55
Sterile Scalpel
Blade Size # 18
Stainless Steel



03-56
Sterile Scalpel
Blade Size # 20
Stainless Steel



03-57
Sterile Scalpel
Blade Size # 21
Stainless Steel



03-58
Sterile Scalpel
Blade Size # 22
Stainless Steel



03-59
Sterile Scalpel
Blade Size # 23
Stainless Steel



03-60
Sterile Scalpel
Blade Size # 24
Stainless Steel



03-61
Sterile Scalpel
Blade Size # 25
Stainless Steel



03-62
Sterile Scalpel
Blade Size # 36
Stainless Steel



03-63
Sterile Scalpel
Blade Size # 40
Stainless Steel



03-64
Sterile Scalpel
Blade Size # 60
Stainless Steel



03-65
Sterile Scalpel
Blade Size # 70
Stainless Steel

Operations-Skalpelle
Bistouris pour operations

Bisturios para operaciones
Bisturi per operazioni



DIEFFENBACH
16 cm



03-66 Fig. 1 16 cm
03-67 Fig. 2 16 cm
03-68 Fig. 3 16 cm
03-69 Fig. 4 16 cm
03-70 Fig. 5 16 cm
03-71 Fig. 6 16 cm
03-72 Fig. 7 16 cm
03-73 Fig. 8 16 cm
03-74 Fig. 9 16 cm
03-75 Fig. 10 16 cm



03-76
Fig. 15
16 cm



03-77
Fig. 16
16 cm

MANZIM
SURGICO



Collin Dissecting Knives
14.5 cm



03-78 Fig. 1 14.5 cm
03-79 Fig. 2 14.5 cm
03-80 Fig. 3 14.5 cm



03-84 Fig. 1 13.5 cm
03-85 Fig. 2 13.5 cm
03-86 Fig. 3 13.5 cm
03-87 Fig. 4 13.5 cm
03-88 Fig. 5 13.5 cm
03-89 Fig. 6 13.5 cm



03-81 Fig. 4 14.5 cm
03-82 Fig. 5 14.5 cm
03-83 Fig. 6 14.5 cm



Dieffenbach Dissecting Knives 13.5 cm
03-90 Fig. 7 13.5 cm
03-91 Fig. 8 13.5 cm
03-92 Fig. 9 13.5 cm
03-93 Fig. 10 13.5 cm



Dissecting Knives
17 cm

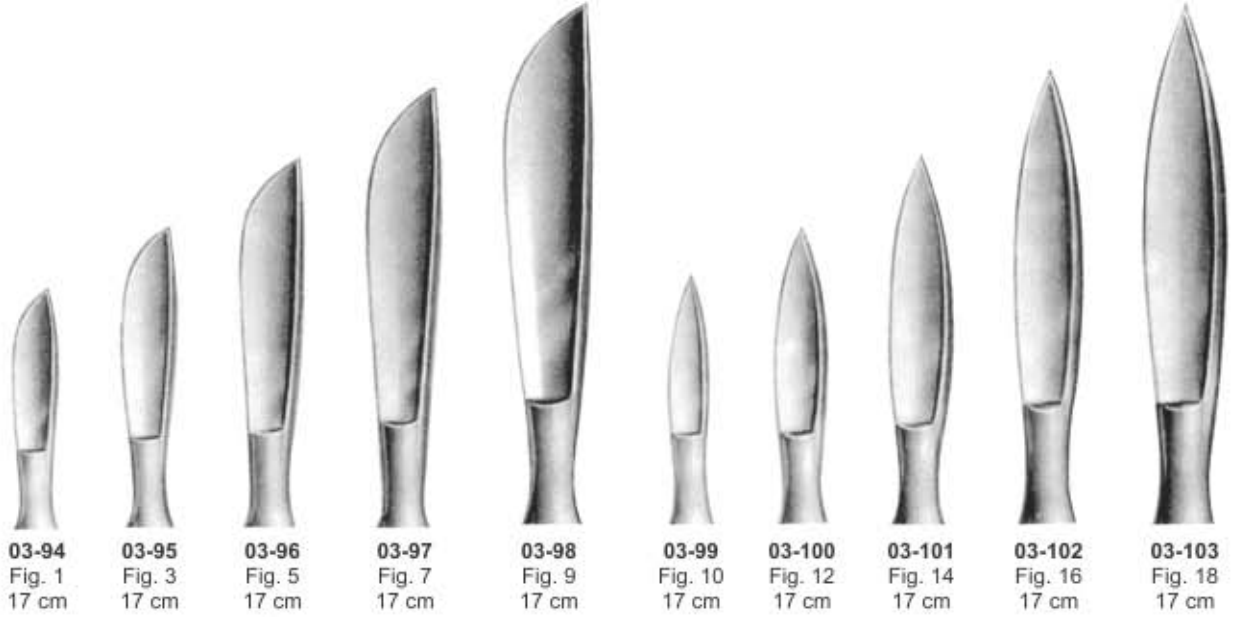

03-94
Fig. 1
17 cm

03-95
Fig. 3
17 cm

03-96
Fig. 5
17 cm

03-97
Fig. 7
17 cm

03-98
Fig. 9
17 cm

03-99
Fig. 10
17 cm

03-100
Fig. 12
17 cm

03-101
Fig. 14
17 cm

03-102
Fig. 16
17 cm

03-103
Fig. 18
17 cm



DISSECTING KNIVES



DISSECTING KNIFE
15 cm
with metal handle

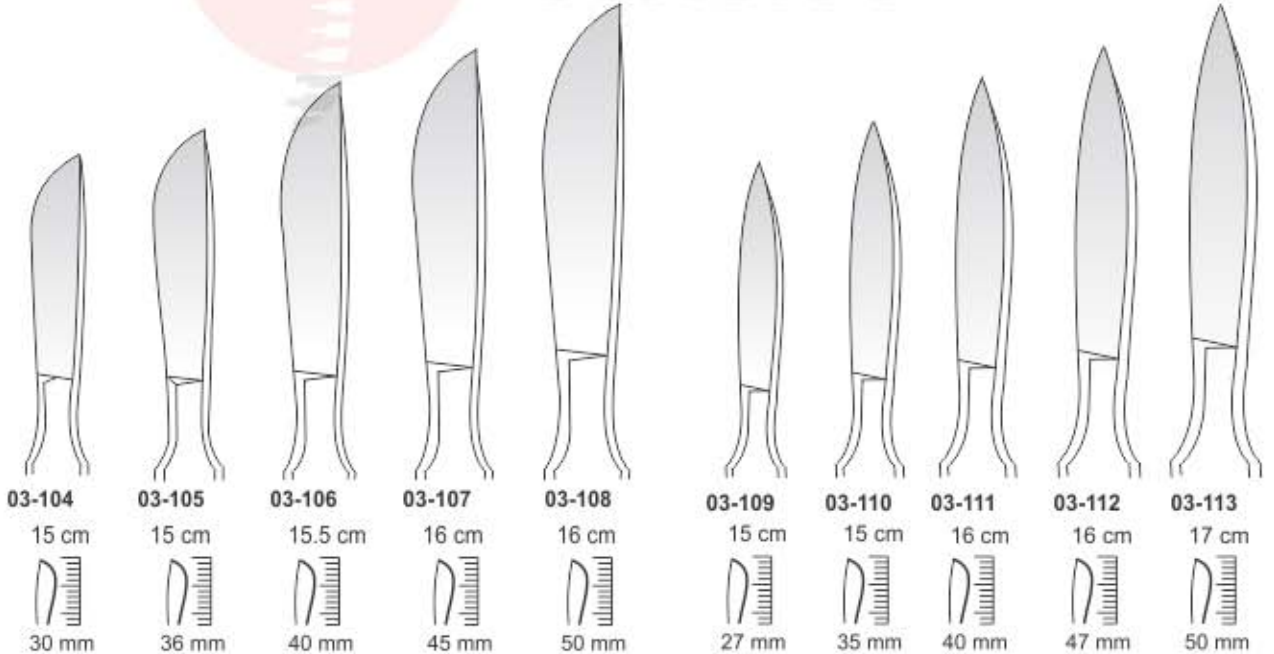

03-104
15 cm
30 mm

03-105
15 cm
36 mm

03-106
15.5 cm
40 mm

03-107
16 cm
45 mm

03-108
16 cm
50 mm

03-109
15 cm
27 mm

03-110
15 cm
35 mm

03-111
16 cm
40 mm

03-112
16 cm
47 mm

03-113
17 cm
50 mm

Anatomische skalpelle
Bisturías para disección

Bistouris à dissection
Bisturi para dissezione



Collin Dissecting Knives Blade Size
03-114 13 cm
03-115 16 cm
03-116 19 cm
03-117 22 cm
03-118 28 cm



Catlin Dissecting Knives Blade Size
03-119 16 cm
03-120 19 cm
03-121 22 cm



Liston Dissecting Knives Blade Size
03-122 16 cm
03-123 19 cm
03-124 22 cm



Langenbeck Dissecting Knives Blade
03-125 12 cm



Amputation Knife
03-126 29 cm



Amputation Knife
03-127 32.5 cm



Catlin Amputation
03-128 29 cm

MANZIM
SURGICO



Resection Knife
03-129 18 cm



Langenbeck Amputation
03-130 18 cm



Langenbeck Amputation
03-131 18 cm



Dieffenbach Dissecting Knives
03-132 13 cm



Dieffenbach Dissecting Knives
03-133 13 cm



Simon Dissecting Knives
23.5 cm



03-134 Fig. 1



03-135 Fig. 2



03-136 Fig. 3



03-137 Fig. 4

DISSECTING KNIVES

Anatomische skalpelle | Bistouris à dissection
Bisturías para disección | Bisturi para dissezione



Autopsy Knife
03-138
25.5 cm

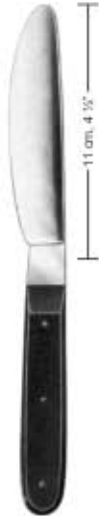

Walb Dissecting Knives
03-139
11 cm

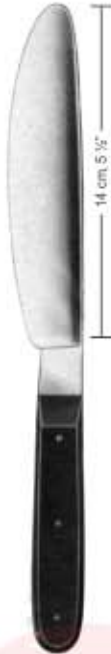

Walb Dissecting Knives
03-140
14 cm



Walb Dissecting Knives
03-141
17 cm



Virchow Dissecting Knives
03-142
16 cm



Virchow Dissecting Knives
03-143
20 cm



Virchow Dissecting Knives
03-144
24 cm



Ayre Cone Knife
03-145
23.5 cm



Cone Knife
03-146
23 cm



Segond Myomatome
03-147
27 cm



Olivecrona Trigeminal knife
03-148
20.5 cm



Trigeminal knife
03-149
23 cm



Fowler Tonsil Knife
03-150
20 cm



Abraham Tonsil Knife
03-151
21.5 cm



Brunings Tonsil knife
03-152
21.5 cm

Dermatome - Transplantationsmesser

Dermatomos - Cuchillos para transplantaciones

Dermatomes - Bistouries pour transplantation

Dermatomi - coltello per trapianto

AMPUTATION KNIVES & RESECTION SAWS

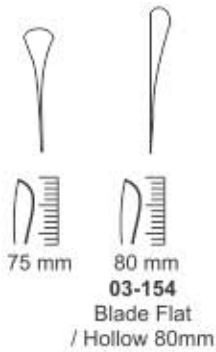

RAZOR HOLLOW
 Blades On Both Sides
 Blade Flat / Hollow
03-153

Charriere Amputation & Resection
03-155 27cm
03-156 30cm

Charriere Amputation & Resection
03-157 35cm

Satterlee Amputation & Resection
03-158 31cm

Thiersch
03-159
 20 cm



03-161
 Spare Blade



03-162
 Skin fixing plate



03-164
 spare blade



Schink
03-160 30cm
 Complete with 1 Blade & 2 plates

Humby Dermatomes
03-163 31cm
 Complete with 1 Blade

Watson Dermatomes
03-165 30cm
 Complete with 1 Blade, fixed bar

Silver Dermatomes
03-166 19cm

GENERAL OPERATING SCISSORS

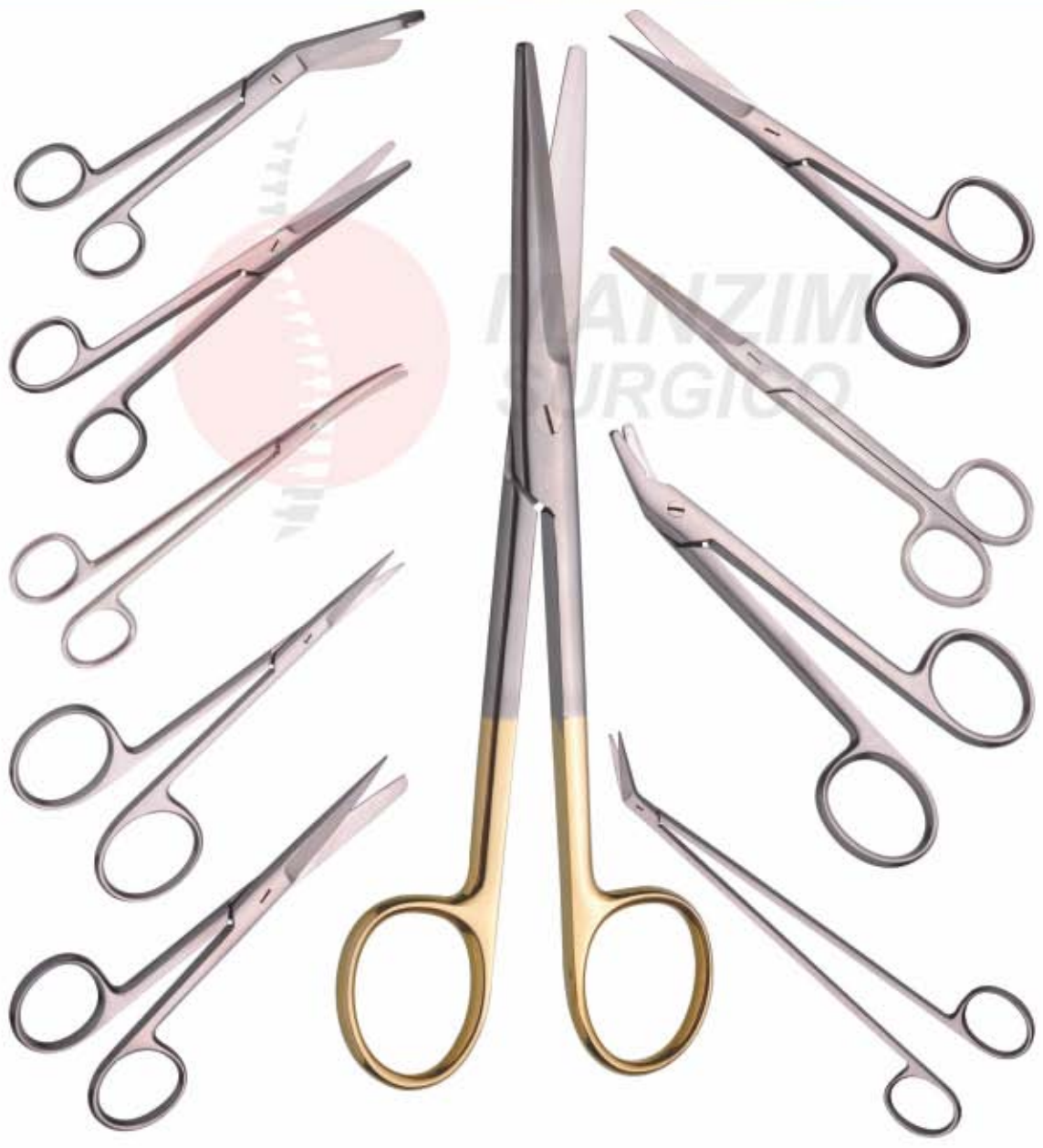

Chirurgische scheren | Ciseaux chirurgicaux
Tijeras quirúrgicas | Forbici per chirurgia

Operating Scissors (Flat Pattern)



Operating Scissors

04-001	11.5 cm	S/S Str.
04-002	12.5 cm	S/S Str.
04-003	13 cm	S/S Str.
04-004	14.5 cm	S/S Str.
04-005	16 cm	S/S Str.
04-006	18 cm	S/S Str.
04-007	20 cm	S/S Str.
04-008	23 cm	S/S Str.
04-009	25 cm	S/S Str.
04-010	28 cm	S/S Str.
04-011	30 cm	S/S Str.



Operating Scissors

04-012	11.5 cm	S/S Cvd
04-013	12.5 cm	S/S Cvd
04-014	13cm	S/S Cvd
04-015	14.5 cm	S/S Cvd
04-016	16 cm	S/S Cvd
04-017	18 cm	S/S Cvd
04-018	20 cm	S/S Cvd
04-019	23 cm	S/S Cvd
04-020	25 cm	S/S Cvd
04-021	28 cm	S/S Cvd
04-022	30 cm	S/S Cvd



Operating Scissors

04-023	11.5 cm	B/B Str.
04-024	12.5 cm	B/B Str.
04-025	13 cm	B/B Str.
04-026	14.5 cm	B/B Str.
04-027	16 cm	B/B Str.
04-028	18 cm	B/B Str.
04-029	20 cm	B/B Str.
04-030	23 cm	B/B Str.
04-031	25 cm	B/B Str.
04-032	28 cm	B/B Str.
04-033	30 cm	B/B Str.



Operating Scissors

04-034	11.5 cm	B/B Cvd
04-035	12.5 cm	B/B Cvd
04-036	13 cm	B/B Cvd
04-037	14.5 cm	B/B Cvd
04-038	16 cm	B/B Cvd
04-039	18 cm	B/B Cvd
04-040	20 cm	B/B Cvd
04-041	23 cm	B/B Cvd
04-042	25 cm	B/B Cvd
04-043	28 cm	B/B Cvd
04-044	30 cm	B/B Cvd



Operating Scissors

04-045	11.5 cm	S/B Str.
04-046	12.5 cm	S/B Str.
04-047	13 cm	S/B Str.
04-048	14.5 cm	S/B Str.
04-049	16 cm	S/B Str.
04-050	18 cm	S/B Str.
04-051	20 cm	S/B Str.
04-052	23 cm	S/B Str.
04-053	25 cm	S/B Str.
04-054	28 cm	S/B Str.
04-055	30 cm	S/B Str.



Operating Scissors

04-056	11.5 cm	S/B Cvd
04-057	12.5 cm	S/B Cvd
04-058	13 cm	S/B Cvd
04-059	14.5 cm	S/B Cvd
04-060	16 cm	S/B Cvd
04-061	18 cm	S/B Cvd
04-062	20 cm	S/B Cvd
04-063	23 cm	S/B Cvd
04-064	25 cm	S/B Cvd
04-065	28 cm	S/B Cvd
04-066	30 cm	S/B Cvd

Operating Scissors

04-067	11.5 cm	S/S Str.
04-068	12.5 cm	S/S Str.
04-069	13 cm	S/S Str.
04-070	14.5 cm	S/S Str.
04-071	16 cm	S/S Str.
04-072	18 cm	S/S Str.
04-073	20 cm	S/S Str.
04-074	23 cm	S/S Str.
04-075	25 cm	S/S Str.
04-076	28 cm	S/S Str.
04-077	30 cm	S/S Str.

Operating Scissors

04-078	11.5 cm	S/S Cvd
04-079	12.5 cm	S/S Cvd
04-080	13 cm	S/S Cvd
04-081	14.5 cm	S/S Cvd
04-082	16 cm	S/S Cvd
04-083	18 cm	S/S Cvd
04-084	20 cm	S/S Cvd
04-085	23 cm	S/S Cvd
04-086	25 cm	S/S Cvd
04-087	28 cm	S/S Cvd
04-088	30 cm	S/S Cvd

Operating Scissors

04-089	11.5 cm	B/B Str.
04-090	12.5 cm	B/B Str.
04-091	13 cm	B/B Str.
04-092	14.5 cm	B/B Str.
04-093	16 cm	B/B Str.
04-094	18 cm	B/B Str.
04-095	20 cm	B/B Str.
04-096	23 cm	B/B Str.
04-097	25 cm	B/B Str.
04-098	28 cm	B/B Str.
04-099	30 cm	B/B Str.

Operating Scissors

04-100	11.5 cm	B/B Cvd
04-101	12.5 cm	B/B Cvd
04-102	13 cm	B/B Cvd
04-103	14.5 cm	B/B Cvd
04-104	16 cm	B/B Cvd
04-105	18 cm	B/B Cvd
04-106	20 cm	B/B Cvd
04-107	23 cm	B/B Cvd
04-108	25 cm	B/B Cvd
04-109	28 cm	B/B Cvd
04-110	30 cm	B/B Cvd

Operating Scissors

04-111	11.5 cm	S/B Str.
04-112	12.5 cm	S/B Str.
04-113	13 cm	S/B Str.
04-114	14.5 cm	S/B Str.
04-115	16 cm	S/B Str.
04-116	18 cm	S/B Str.
04-117	20 cm	S/B Str.
04-118	23 cm	S/B Str.
04-119	25 cm	S/B Str.
04-120	28 cm	S/B Str.
04-121	30 cm	S/B Str.

Operating Scissors

04-122	11.5 cm	S/B Cvd
04-123	12.5 cm	S/B Cvd
04-124	13 cm	S/B Cvd
04-125	14.5 cm	S/B Cvd
04-126	16 cm	S/B Cvd
04-127	18 cm	S/B Cvd
04-128	20 cm	S/B Cvd
04-129	23 cm	S/B Cvd
04-130	25 cm	S/B Cvd
04-131	28 cm	S/B Cvd
04-132	30 cm	S/B Cvd

Bedienen & Präparierscheren

D'exploitation & Ciseaux de dissection

Funcionamiento y disección Tijeras

Forbici di funzionamento e di dissezione



04-133
12.5 cm
B/B Str.

**LANDOLT OPERATING
SCISSORS**



04-134
12.5 cm
B/B Cvd.



**DEAVER OPERATING,
DISSECTING SCISSORS**



04-135
14.5 cm
S/B Str.



04-136
14.5 cm
S/B Cvd.



04-137
14.5 cm
S/B Str.
Saw Edge.



04-138
14.5 cm
S/B Cvd.
Saw Edge.



04-139
14.5 cm
S/B Str.

**LONGE OPERATING,
DISSECTING SCISSORS**



04-140
14.5 cm
S/B Cvd.



04-141
14.5 cm
S/B Str.
Saw Edge.



04-142
14.5 cm
S/S Cvd.
Saw Edge.



INCISION OPERATING SCISSORS



04-143 13.0 cm
04-144 14.5 cm
S/S Str.



- 04-145**
14.5 cm
- 04-146**
15.0 cm
- 04-147**
17.0 cm
- 04-148**
19.5 cm
- 04-149**
21.0 cm
- 04-150**
23.0 cm
B/B, Str.
- 04-151**
14.5 cm
- 04-152**
15.0 cm
- 04-153**
17.0 cm
- 04-154**
19.5 cm
- 04-155**
21.0 cm
- 04-156**
23.0 cm
B/B, Cvd.

MAYO DISSECTING & GYNECOLOGICAL SCISSORS



- 04-157**
15.0 cm
- 04-158**
17.0 cm
- 04-159**
19.5 cm
- 04-160**
21.0 cm
B/B, Str.
- 04-161**
15.0 cm
- 04-162**
17.0 cm
- 04-163**
19.5 cm
- 04-164**
21.0 cm
B/B, Cvd.

MAYO-STILLE DISSECTING & GYNECOLOGICAL SCISSORS



- 04-165**
22.5 cm
B/B, Str.
- 04-166**
22.5 cm
B/B, Cvd.

MAYO-HARRINGTON DISSECTING & GYNECOLOGICAL SCISSORS



- 04-167**
17.0 cm
B/B, Cvd.
- 04-168**
17.0 cm
B/B, Str.

MAYO-NOBLE DISSECTING & GYNECOLOGICAL SCISSORS

Bedienen & Präparierscheren

D'exploitation & Ciseaux de dissection

Funcionamiento y disección Tijeras

Forbici di funzionamento e di dissezione



**METZENBAUM OPERATING,
DISSECTING SCISSORS
BLUNT/BLUNT STR.**

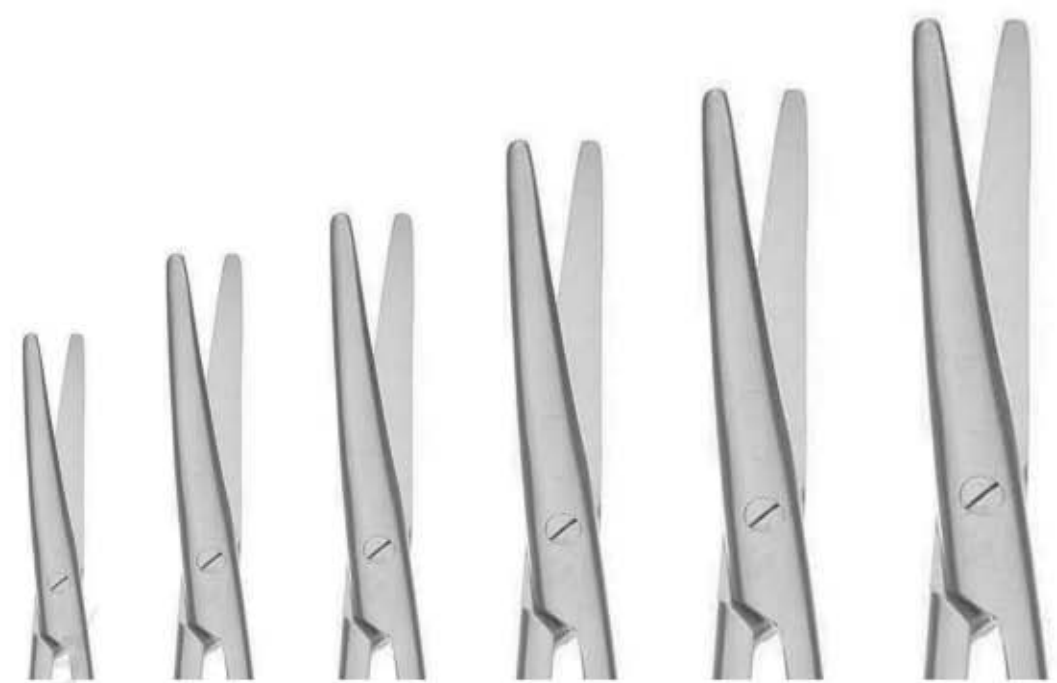

04-169
14.5 cm
B/B Str.

04-170
18 cm
B/B Str.

04-171
20 cm
B/B Str.

04-172
23 cm
B/B Str.

04-173
25 cm
B/B Str.

04-174
28 cm
B/B Str.

MANZIM
SURGICO



**METZENBAUM OPERATING,
DISSECTING SCISSORS
BLUNT/BLUNT CVD.**



04-175
14.5 cm
B/B Cvd.

04-176
18 cm
B/B Cvd.

04-177
20 cm
B/B Cvd.

04-178
23 cm
B/B Cvd.

04-179
25 cm
B/B Cvd.

04-180
28 cm
B/B Cvd.

Bedienen & Präparierscheren
Funcionamiento y disección Tijeras

D'exploitation & Ciseaux de dissection
Forbici di funzionamento e di dissezione

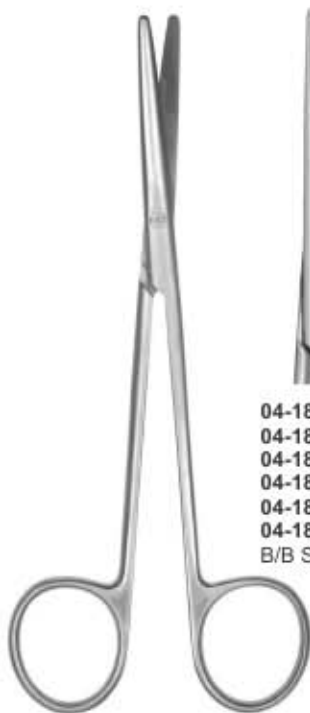

**METZENBAUM-NELSON
SCISSORS**

	04-181 18cm		04-187 18cm		04-193 18cm
	04-182 20cm		04-188 20cm		04-194 20cm
	04-183 23cm		04-189 23cm		04-195 23cm
	04-184 25cm		04-190 25cm		04-196 25cm
	04-185 28cm		04-191 28cm		04-197 28cm
	04-186 30cm		04-192 30cm		04-198 30cm
	B/B Str.		S/B Str.		S/S Str.

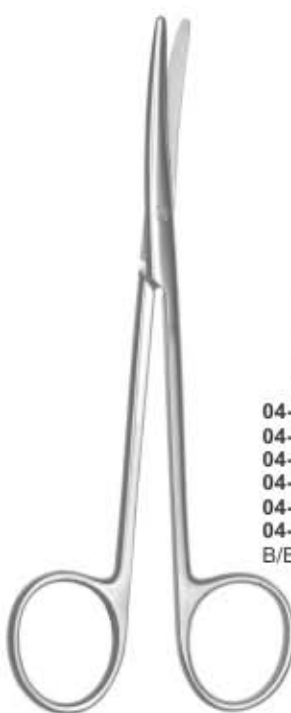

**METZENBAUM-NELSON
SCISSORS**

	04-199 18cm		04-205 18cm		04-211 18cm
	04-200 20cm		04-206 20cm		04-212 20cm
	04-201 23cm		04-207 23cm		04-213 23cm
	04-202 25cm		04-208 25cm		04-214 25cm
	04-203 28cm		04-209 28cm		04-215 28cm
	04-204 30cm		04-210 30cm		04-216 30cm
	B/B Cvd.		S/B Cvd.		S/S Cvd.



**METZENBAUM-FINO
SCISSORS**

	04-217 14.5 cm		04-218 14.5 cm		04-219 14.5 cm		04-220 14.5 cm
	B/B Str.		S/S Str.		B/B Cvd.		S/S Cvd.



**METZENBAUM-FINO
SCISSORS**

	04-221 18 cm		04-224 18 cm		04-227 18 cm
	04-222 220 cm		04-225 220 cm		04-228 220 cm
	04-223 230 cm		04-226 230 cm		04-229 230 cm
	B/B Str.		B/B Cvd.		B/B Slightly Cvd.

OPERATING & DISSECTING SCISSORS

Bedienen & Präparierscheren

D'exploitation & Ciseaux de dissection

Funcionamiento y disección Tijeras

Forbici di funzionamento e di dissezione



**RICHTER OPERATING,
DISSECTING SCISSORS**
04-230 14.5cm
Angled



04-231
14cm
S/S Str.

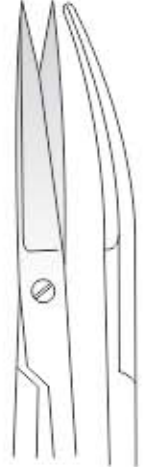

04-232
14cm
S/S Cvd



**KELLY OPERATING,
DISSECTING SCISSORS**

04-233
16cm
04-234
18cm
S/S Str.



04-235
16cm
04-236
18cm
S/S Cvd.



**DOYEN OPERATING,
DISSECTING SCISSORS**
04-237 17.5 cm
B/B, Str.



**DOYEN OPERATING,
DISSECTING SCISSORS**
04-238 17.5 cm
B/B, Cvd.





SIMS DISSECTING & GYNECOLOGICAL SCISSORS

- 04-239 20cm
- 04-240 23cm
- Str, B/B



- 04-241 20cm
- 04-242 23cm
- Str, S/B



- 04-243 20cm
- 04-244 23cm
- Str, S/S



- 04-245 20cm
- 04-246 23cm
- Cvd, B/B



- 04-247 20cm
- 04-248 23cm
- Cvd, S/B



- 04-249 20cm
- 04-250 23cm
- Cvd, S/S



MANZIM
SURGICO



Iris Scissors



- 04-251 09 cm
- 04-252 10.5 cm
- 04-253 11.5 cm
- 04-254 12.0 cm
- S/S Str.



- 04-255 09 cm
- 04-256 10.5 cm
- 04-257 11.5 cm
- 04-258 12.0 cm
- S/S Cvd.



- 04-259 11.5 cm
- Angular Left



- 04-262 9 cm
- 04-263 10cm
- 04-264 11.5cm
- 04-265 12cm
- S/S Str.



- 04-260 11.5 cm
- Laterally Cvd.



- 04-261 11.5 cm
- Angular Right



Iris Scissors



- 04-266 9 cm
- 04-267 10cm
- 04-268 11.5cm
- 04-269 12cm
- S/S Cvd.

OPERATING SCISSORS

Chirurgische scheren
Tijeras Para Cirugia

Ciseaux à chirurgie
Forbici per chirurgia



VASCULAR SCISSORS
04-270 19cm
S/S Angled 125°



COOLEY REVERSE CUT SCISSORS
04-271 17cm
S/S angled 125°



POTTS-SMITH VASCULAR SCISSORS
S/S Angled



04-272
19cm
25°



04-273
19cm
45°



04-274
19cm
60°



04-275
19cm
125°



HEGEMANN-DIETHRICH VASCULAR SCISSORS
S/S Angled



25°
04-276 16cm
04-277 19cm



45°
04-278 16cm
04-279 19cm



60°
04-280 16cm
04-281 19cm



25°
04-286 16cm
04-287 19cm
04-288 23cm
04-289 28cm



45°
04-290 16cm
04-291 19cm
04-292 23cm
04-293 28cm



90°
04-282 16cm
04-283 19cm



125°
04-284 16cm
04-285 19cm



DE BAKEY VASCULAR SCISSORS
S/S Angled

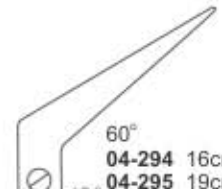

60°
04-294 16cm
04-295 19cm
04-296 23cm
04-297 28cm

VASCULAR SCISSORS

Gefäßschere | Ciseaux vasculaires
Tijeras vasculares | Forbici vascolari

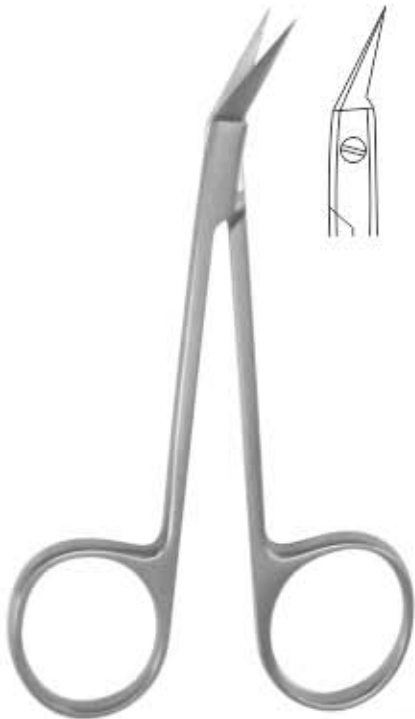

O'BRIEN VASCULAR SCISSORS
04-298 9cm
S/S Angled

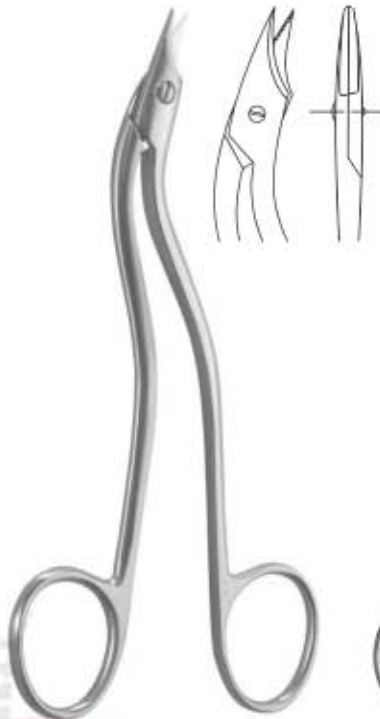

HEATH VASCULAR SCISSORS
04-299 15cm
S/S Double Cvd.



COOLEY VASCULAR SCISSORS
04-300 18.4 cm, 1 mm
04-301 18.4 cm, 1.5 mm
probe point on tip.
S/S Angled 45°



04-302
17cm
Serrated
Blade S/S
Double Cvd.

DEAN-DELICATE DISSECTING SCISSORS

DISSECTING & NASAL SCISSORS

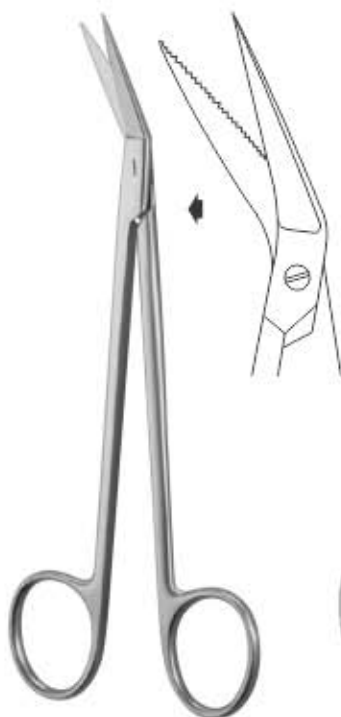

Locklin Dissecting Scissors
04-303 16.5cm
S/S

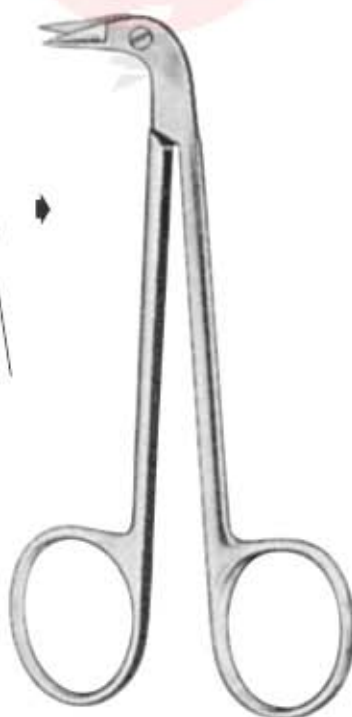

FAVALORO CORONARY
04-304 10.5 cm
S/S Angled 90°



ENT-DEAN SCISSORS
04-305 17cm
S/S Double Cvd.
Serrated



DE BAKKEY VASCULAR SCISSORS

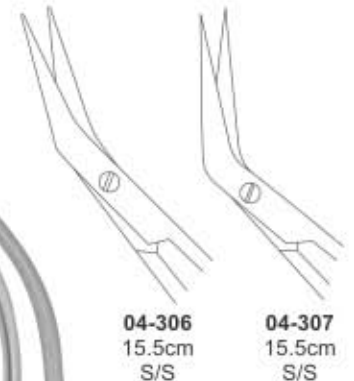

04-306
15.5cm
S/S

04-307
15.5cm
S/S

STITCH SCISSORS

stitch Schere | point de ciseaux
 Coser Tijeras | Stitch Forbici

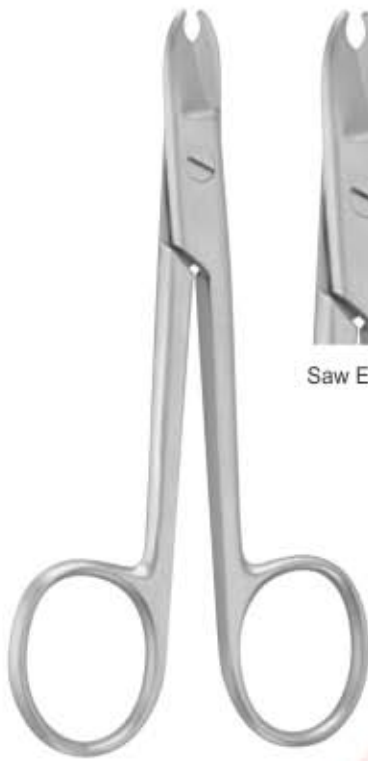

Saw Edge

STITCHES SCISSORS
 04-308 12.0 cm
 Str.



NORTHBENT STITCHES SCISSORS
 04-309 12.5 cm
 Cvd.

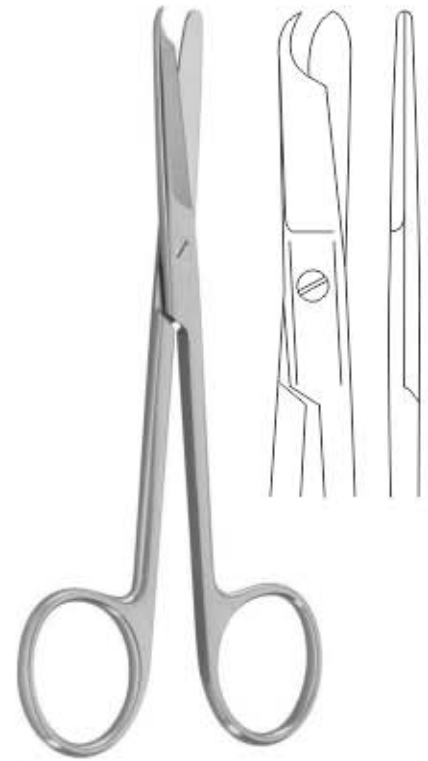

LITTAUER STITCH SCISSORS
 04-310 14 cm
 Str.



04-311
 14.5 cm
 Str.

BUCK STITCH SCISSORS

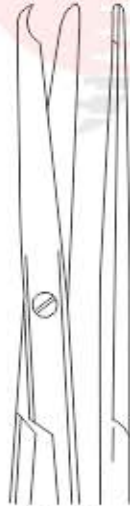

04-312
 18.0 cm
 Str.

SPENCER STITCH SCISSORS

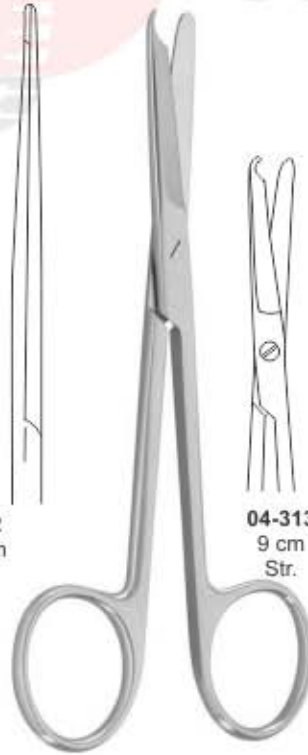

04-313
 9 cm
 Str.



04-314
 11.5 cm
 Str.



SHORTBENT STITCH SCISSORS
 04-315 9 cm
 Cvd.

Tonsillensteinen Schere, Nasenschere
Tijeras de amígdalas, tijeras nasales

Ciseaux d'amygdale, Ciseaux nasaux
Tonsille forbici, forbici nasali

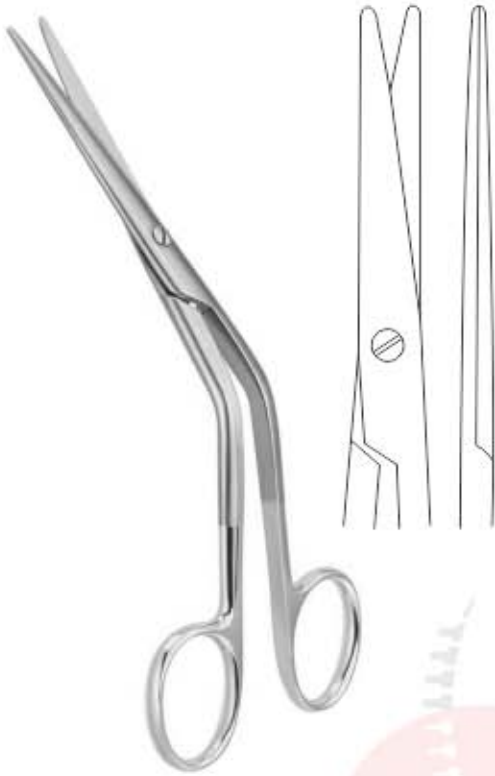

COTTLE SCISSORS
04-316 16 cm
B/B, Angled



FOMON SCISSORS
04-317 14.5 cm
B/B, Angled



SAILER SCISSORS
04-318 17.0 cm
B/B, Angled



HEYMANN SCISSORS
04-319 18 cm
04-320 19.5 cm
B/B, Angled



HEYMANN SCISSORS
04-321 18.0 cm
B/B, Angled



OLIVECRONA VASCULAR SCISSORS
04-322 23.0 cm
B/B

Chirurgische scheren, Gum Scheren
Goma Tijeras y tijeras de funcionamiento

Gum Ciseaux et Ciseaux d'exploitation
Gum Forbici & Forbici Operativi



GOOD SCISSORS
04-323 19.0 cm
Probe End, Cvd.



PRINCE SCISSORS
04-324 17.5 cm
B/B, Cvd.



HALLE SCISSORS
04-325 19.0 cm
B/B, Cvd.



04-326
14.5 cm
Pointed Tip
S/S, Str.



04-327
14.5 cm
Pointed Tip
S/S, Cvd.

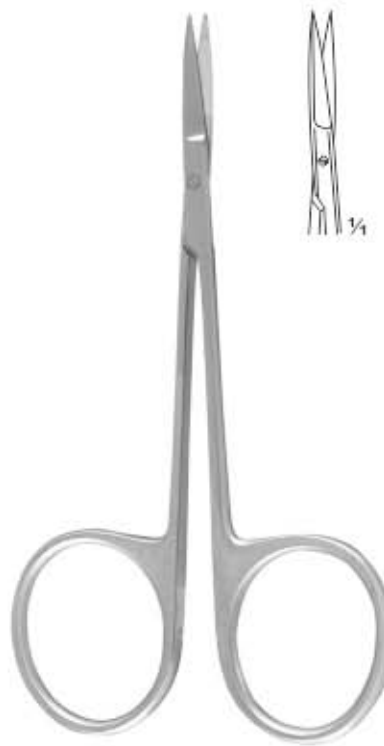

MOD. BONN SCISSORS
04-328 8.0 cm
S/S, Str.



MOD. BONN SCISSORS
04-329 8.0 cm
S/S, Cvd.

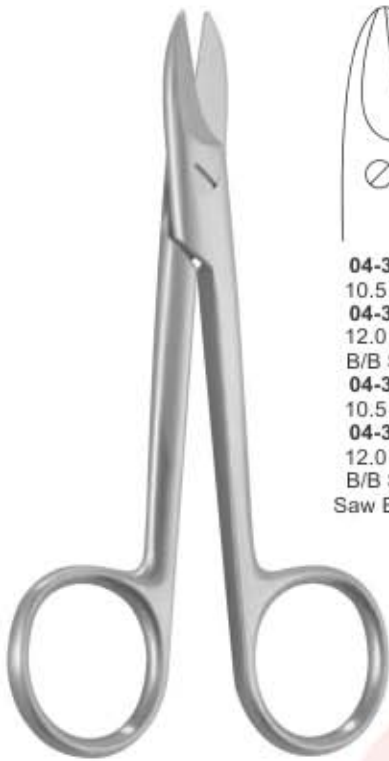

04-330
10.5 cm
04-331
12.0 cm
B/B Str.
04-332
10.5 cm
04-333
12.0 cm
B/B Str.
Saw Edge



04-334
10.5 cm
04-335
12.0 cm
S/S Str.
04-336
10.5 cm
04-337
12.0 cm
S/S Str.
Saw Edge



04-338
10.0 cm
04-339
12.0 cm
B/B Cvd.
04-340
10.0 cm
04-341
12.0 cm
B/B Cvd.
Saw Edge



04-342
10.0 cm
04-343
12.0 cm
S/S Cvd.
04-344
10.0 cm
04-345
12.0 cm
S/S Cvd.
Saw Edge

BEEBEE WIRE CUTTING SCISSORS

BEEBEE WIRE CUTTING SCISSORS



SYSTRUNK
04-346
13.0 cm
S/S, Str.



SYSTRUNK
04-347
13.0 cm
S/S, Cvd.

SYSTRUNK SCISSORS



UNIVERSAL WIRE CUTTING SCISSORS
04-348 12 cm

Nagelzangen, Nagelscheren

Pinzas para uñas, tijeras de uñas

Pince à ongles, ciseaux à ongles

Tronchesi per unghie, forbici per unghie



04-349
10 cm
04-350
11.5 cm
S/S Str.

STEVENS SCISSORS



04-351
10 cm
04-352
11.5 cm
S/S Cvd.



STEVENS SCISSORS



04-353
10 cm
04-354
11.5 cm
B/B Str.



04-355
10 cm
04-356
11.5 cm
B/B Cvd.



NAIL SCISSORS
04-357 9 cm S/S, Cvd.



NAIL SCISSORS
04-358 9 cm
S/S, Cvd.



NAIL SCISSORS
04-359 9 cm
Arrow Point Curved



NAIL NIPPERS
04-360 11 cm
04-361 13 cm
04-362 15 cm



NAIL NIPPERS
04-363 14 cm



NAIL NIPPERS
04-364 14 cm



TURNBULL NIPPERS
04-365 11.5 cm
04-366 13 cm



NAIL NIPPERS
04-367 10.5 cm



COHEN NIPPERS
04-368 10.5 cm

Mikroscheren | *micro Ciseaux*
Micro Tijeras | *Micro Forbici*



**ARTERY
SCISSORS**
Probe end
Angled



04-369
18.0 cm
25°



04-370
18.0 cm
45°



04-371
18.0 cm
60°



04-372
18.0 cm
90°

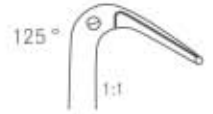

04-373
18.0 cm
125°



04-374
18.0 cm
25°



04-375
18.0 cm
45°



04-376
18.0 cm
60°



04-377
18.0 cm
90°



04-378
18.0 cm
125°



CASTROVIEJO SCISSORS
Spring Type



04-379
9.0 cm
S/B Str.



04-380
9.0 cm
S/B Cvd.



04-381
9.0 cm
S/S Str.



04-382
9.0 cm
S/S Cvd.



04-383
11.4 cm
B/B Str.



04-384
11.4 cm
B/B Cvd.



04-385
11.4 cm
S/B Str.



04-386
11.4 cm
S/B Cvd.



04-387
11.4 cm
S/S Str.



04-388
11.4 cm
S/S Cvd.



04-389
14 cm
B/B Str.



04-390
14 cm
B/B Cvd.



04-391
14 cm
S/B Str.

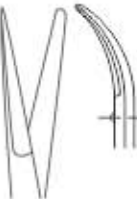

04-392
14 cm
S/B Cvd.



04-393
14 cm
S/S Str.

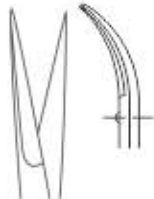

04-394
14 cm
S/S Cvd.

MICRO SCISSORS

Mikroscheren | micro Ciseaux
 Micro Tijeras | Micro Forbici



NOYES SCISSORS
Spring Handle



04-395
12 cm
S/S



04-396
12 cm
S/B



04-397
12 cm
B/B



NOYES SCISSORS
Spring Handle
04-398 12cm
Angled,



WECKER SCISSORS
Angled



04-399
11.0 cm
S/B



04-400
11.0 cm
B/B



04-401
11.0 cm
S/S



BARRAQUER SCISSORS
04-402 Sharp Points
04-403 Blunt Points
5.5 cm



CASTROVIEJO CORNEAL MICRO SCISSORS
04-404 11cm
Left Angled,
Spring Handle



CASTROVIEJO CORNEAL MICRO SCISSORS
04-405 11cm
Right Angled,
Spring Handle



TROUTMAN MICRO SCISSORS
04-406 10cm
Left Angled,
Spring Handle



TROUTMAN MICRO SCISSORS
04-407 10cm
Right Angled,
Spring Handle



WESTCOTT MICRO SCISSORS



04-408
11.0 cm
S/S Str.



04-410
11.0 cm
S/S Cvd.

04-409
13.3 cm
S/S Str.

04-411
13.3 cm
S/S Cvd.



MICRO SCISSORS
04-412 12cm
S/S, Cvd.



MICRO SCISSORS
S/S, Angled



04-413
18.0 cm
25°



04-414
18.0 cm
45°



04-415
18.0 cm
60°



04-416
18.0 cm
90°



04-417
18.0 cm
125°



MICRO SCISSORS
S/S, Angled pointed probe



04-418
18.0 cm
25°

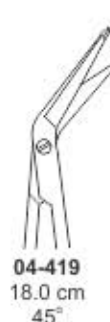

04-419
18.0 cm
45°



04-420
18.0 cm
60°



04-421
18.0 cm
90°



04-422
18.0 cm
125°

MANZIM
SURGICO



YASARGILL SCISSORS



04-423 16 cm
04-424 20 cm
04-425 22.5cm
S/S, Str.



04-426 16cm
04-427 20cm
04-428 22cm
S/S, Cvd.



04-429 16cm
04-430 20cm
04-431 22cm
B/B, Str.



04-432 16cm
04-433 20cm
04-434 22cm
S/S, Str.



04-435 16cm
04-436 20cm
04-437 22cm
S/S, Cvd.



04-438 16cm
04-439 20cm
04-440 22cm
B/B, Cvd.



NOYES MICRO SCISSORS
04-441 15cm
S/S



NOYES MICRO SCISSORS
04-442 14.5cm
S/S

PLASTER SCISSORS

Gips Schere
Tijeras Yeso

plâtre Ciseaux
intonaco Forbici



ESMARCH KNIFE
04-443 18cm



BRUNS SCISSORS



04-444
24 cm
Cvd, Probe End



04-445
24cm
Cvd, Serrated
Probe End



**LISTER-EXCENTRIC
PLASTER SCISSORS**

04-446 16 cm
04-447 19 cm
Angled, Probe End



Saw Edge Upper
Teeth is Serrated



LISTER BANDAGE PLASTER

Scissors, one large ring
04-448 9 cm
04-449 11 cm
04-450 14 cm
04-451 15 cm
04-452 18 cm
04-453 20 cm
Angled, Probe End



BERGMANN SCISSORS
04-454 23 cm
Angled, Probe End



ESMARCH SCISSORS
04-455 20 cm
04-456 23 cm
Angled, Probe End



**LISTER BANDAGE
PLASTER SCISSORS**
04-457 9 cm
04-458 11 cm
04-459 14 cm
04-460 15 cm
04-461 18 cm
04-462 20 cm
Angled, Probe End



PLASTER SCISSORS
04-463 17 cm
Angled



**BURNHAM BANDAGE
PLASTER SCISSORS**
04-464 14 cm
Angled

Gips Schere
Tijeras Yeso

plâtre Ciseaux
intonaco Forbici



BANDAGE SCISSORS
04-465 16.0 cm



**SMITH (Mod. Usa)
PLASTER SCISSORS**
04-466 16 cm
04-467 18 cm
04-468 20 cm
04-469 23 cm



**LORENZ PLASTER
SCISSORS**
04-470 23 cm
B/B, Cvd



**LANGE BANDAGE
SCISSORS**
04-471 18.0 cm
B/B



**BRAUN-STADLER
PLASTER SCISSORS**
04-472 14cm
04-473 22cm
B/B, Angled



**BUSCH PLASTER
SCISSORS**
04-474 13 cm
04-475 16 cm
B/B, Cvd.



**KNOWLES PLASTER
SCISSORS**
04-476 14 cm
Str. Probe End



**KNOWLES PLASTER
SCISSORS**
04-477 14 cm
Angled, Probe End



**WALDMANN PLASTER
SCISSORS**
04-478 18 cm
Probe End

MANZIM
SURGICO

PLASTER SCISSORS

Gips Schere
Tijeras Yeso

plâtre Ciseaux
intonaco Forbici



WALDMANN SCISSORS
04-479 18 cm



SCHUMACHER PLASTER SCISSORS
04-480 16 cm



MODIFIED-USA PLASTER SCISSORS
04-481 10.5 cm



MARBACH PLASTER SCISSORS
04-482 15.5 cm
Probe End, Serrated blade



SEUTIN PLASTER SCISSORS
04-483 20cm
Probe End



SEUTIN PLASTER SCISSORS
04-484 23cm
Probe End

PLASTER SHEARS

GipsScheren
Tijeras Yeso

plâtres Ciseaux
Cesoie in gesso



Stille Plaster Shears
04-485 23 cm
04-486 26 cm
04-487 37 cm
04-488 Spare Blade



STILLE PLASTER SHEARS
04-489 24 cm
04-490 Spare Blade



**HENNIG PLASTER
CAST SPREADER**
04-491 28 cm



MODEL USA CAST SPREADER PLASTER
04-492 23 cm 3 Prong



3/4



SPREADER PLASTER
04-493 29 cm



3/4

With removable jaws



WOLFF SPREADER PLASTER
04-494 18 cm
04-495 24 cm

Super Cut Schere | Ciseaux SuperCut
 Súper Cut Tijeras | Forbici SuperCut



Standard Operating Super Cut Scissors



04-496
14.5 cm
04-497
16.5 cm
Str. B/B



04-498
14.5 cm
04-499
16.5 cm
Str. S/B



04-500
14.5 cm
04-501
16.5 cm
Str. S/S



Standard Operating Super Cut Scissors



04-502
14.5 cm
04-503
16.5 cm
Cvd. B/B



04-504
14.5 cm
04-505
16.5 cm
Cvd. S/B



04-506
14.5 cm
04-507
16.5 cm
Cvd. S/S



Lexer Operating Super Cut Scissors



04-508 16 cm
04-509 21 cm
B/B, Str.



04-510 16.5 cm
04-511 21 cm
B/B, Cvd.



Safety Super Cut Scissors
04-512 Str.
04-513 Cvd.
9.0 cm, Probe Ends



Goldman-fox Super Cut Scissors
04-514 Str.
04-515 Cvd.
9.0 cm, S/S



Stevens Tenotomy Super Cut Scissors
04-516 Str.
04-517 Cvd.
9.0 cm, B/B



Stevens Tenotomy Super Cut Scissors
04-518 Str.
04-519 Cvd.
11.5 cm, S/S



BABY METZENBAUM SUPER CUT SCISSORS
04-520 11.5 cm
B/B, Str.



BABY METZENBAUM SUPER CUT SCISSORS
04-521 11.5 cm
B/B, Cvd.



IRIS SUPER CUT SCISSORS
04-522 9.0 cm
04-523 11.5 cm
S/S, Str.



IRIS SUPER CUT SCISSORS
04-524 9.0 cm
04-525 11.5 cm
S/S, Cvd.

Chirurgische scheren
Tijeras quirúrgicas

Ciseaux chirurgicaux
Forbici per chirurgia



**Operating Scissors, S/S Str.
T/C Insert**

04-526	11.5 cm
04-527	13.0 cm
04-528	14.0 cm
04-529	15.0 cm
04-530	16.0 cm
04-531	17.5 cm
04-532	18.5 cm
04-533	20.0 cm



**Operating Scissors, S/S Cvd.
T/C Insert**

04-534	11.5 cm
04-535	13.0 cm
04-536	14.0 cm
04-537	15.0 cm
04-538	16.0 cm
04-539	17.5 cm
04-540	18.5 cm
04-541	20.0 cm



**Operating Scissors, B/B Str.
T/C Insert**

04-542	11.5 cm
04-543	13.0 cm
04-544	14.0 cm
04-545	15.0 cm
04-546	16.0 cm
04-547	17.5 cm
04-548	18.5 cm
04-549	20.0 cm



**Operating Scissors, B/B Cvd.
T/C Insert**

04-550	11.5 cm
04-551	13.0 cm
04-552	14.0 cm
04-553	15.0 cm
04-554	16.0 cm
04-555	17.5 cm
04-556	18.5 cm
04-557	20.0 cm



**Operating Scissors, S/B
Standard Str. T/C Insert**

04-558	11.5 cm
04-559	13.0 cm
04-560	14.0 cm
04-561	15.0 cm
04-562	16.0 cm
04-563	17.5 cm
04-564	18.5 cm
04-565	20.0 cm



**Operating Scissors, S/B
Standard Cvd. T/C Insert**

04-566	11.5 cm
04-567	13.0 cm
04-568	14.0 cm
04-569	15.0 cm
04-570	16.0 cm
04-571	17.5 cm
04-572	18.5 cm
04-573	20.0 cm

Chirurgische scheren | Ciseaux chirurgicaux
Tijeras quirúrgicas | Forbici per chirurgia



Metzenbaum Operating Scissors T/C Insert

		
04-574	04-576	04-578
11.5 cm	11.5 cm	11.5 cm
04-575	04-577	04-579
14.5 cm	14.5 cm	14.5 cm
B/B Str.	S/B Str.	S/S Str.



Metzenbaum Operating Scissors T/C Insert

		
04-580	04-582	04-584
11.5 cm	11.5 cm	11.5 cm
04-581	04-583	04-585
14.5 cm	14.5 cm	14.5 cm
B/B Cvd.	S/B Cvd.	S/S Cvd.



Metzenbaum-Fino Operating Scissors T/C Insert

	
04-586	04-590
14.5 cm	14.5 cm
04-587	04-591
18 cm	18 cm
04-588	04-592
20 cm	20 cm
04-589	04-593
23 cm	23 cm
B/B Str.	B/B Cvd.



Metzenbaum-Fino Operating Scissors T/C Insert

	
04-594	04-598
14.5 cm	14.5 cm
04-595	04-599
18 cm	18 cm
04-596	04-600
20 cm	20 cm
04-597	04-601
23 cm	23 cm
S/S Str.	S/S Cvd.





Metzenbaum-Nelson Operating Scissors T/C Insert

		
04-602	04-608	04-614
18 cm	18 cm	18 cm
04-603	04-609	04-615
20 cm	20 cm	20 cm
04-604	04-610	04-616
23 cm	23 cm	23 cm
04-605	04-611	04-617
25 cm	25 cm	25 cm
04-606	04-612	04-618
28 cm	28 cm	28 cm
04-607	04-613	04-619
30 cm	30 cm	30 cm
B/B Str.	S/B Str.	S/S Str.



Metzenbaum-Nelson Operating Scissors T/C Insert

		
04-620	04-626	04-632
18 cm	18 cm	18 cm
04-621	04-627	04-633
20 cm	20 cm	20 cm
04-622	04-628	04-634
23 cm	23 cm	23 cm
04-623	04-629	04-635
25 cm	25 cm	25 cm
04-624	04-630	04-636
28 cm	28 cm	28 cm
04-625	04-631	04-637
30 cm	30 cm	30 cm
B/B Cvd.	S/B Cvd.	S/S Cvd.



Mayo Dissecting & Gynecological Scissors
T/C Insert



04-638	04-642
14.5 cm	14.5 cm
04-639	04-643
15.0 cm	15.0 cm
04-640	04-644
17.0 cm	17.0 cm
04-641	04-645
23.0 cm	23.0 cm
B/B, Str.	B/B, Cvd.



Mayo-stille Dissecting & Gynecological Scissors
T/C Insert



04-646	04-650
15.0 cm	15.0 cm
04-647	04-651
17.0 cm	17.0 cm
04-648	04-652
19.5 cm	19.5 cm
04-649	04-653
21.0 cm	21.0 cm
B/B, Str.	B/B, Cvd.



ENT-DEAN SCISSORS
04-654 17 cm
S/S Double Cvd.
Serrated



KELLY OPERATING, DISSECTING SCISSORS



04-655	04-657
16.0 cm	16.0 cm
04-656	04-658
18.0 cm	18.0 cm
S/S Str.	S/S Cvd.



Goldmann-Fox Operating Scissors
T/C Insert



04-659	04-660
13 cm	13 cm
S/S Str.	S/S Cvd.



WIRE CUTTING SCISSORS
04-661 12 cm



Chirurgische scheren
Tijeras quirúrgicas

Ciseaux chirurgicaux
Forbici per chirurgia



Lister Bandage Plaster Scissors T/C Insert,
one large ring
04-662 8.9cm
04-663 11.43 cm
04-664 14 cm
04-665 16 cm
04-666 18 cm
04-667 20 cm



Lister Bandage Plaster Scissors, T/C Insert
04-668 8.9cm
04-669 11.43 cm
04-670 14 cm
04-671 16 cm
04-672 18 cm
04-673 20 cm



Castroviejo Scissors T/C Insert



04-674
14 cm
B/B Str.

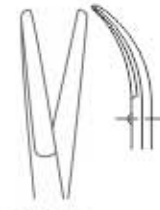

04-675
14 cm
B/B Cvd.



04-676
14 cm
S/B Str.

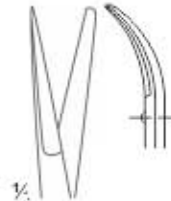

04-677
14 cm
S/B Cvd.



04-678
14 cm
S/S Str.



04-679
14 cm
S/S Cvd.

MANZIM SURGICO



04-680
14 cm
S/S Str.



04-681
14 cm
S/S Cvd.



04-682
16 cm
S/S Str.



04-684
16 cm
S/S Cvd.



Foman Operating Scissors T/C Insert
04-686
13 cm Full Bent



04-687
10 cm
Str.



04-689
10 cm
Cvd.

04-688
11 cm
Str.

04-690
11 cm
Cvd.

Universal Paramedic Shear



04-691 14cm (PINK)
04-692 16cm (PINK)
04-693 18cm (PINK)



04-709 14cm (ORANGE)
04-710 16cm (ORANGE)
04-711 18cm (ORANGE)



04-694 14cm (BLUE)
04-695 16cm (BLUE)
04-696 18cm (BLUE)



04-712 14cm (GREEN)
04-713 16cm (GREEN)
04-714 18cm (GREEN)



04-697 14cm (YELLOW)
04-698 16cm (YELLOW)
04-699 18cm (YELLOW)



04-715 14cm (WHITE)
04-716 16cm (WHITE)
04-717 18cm (WHITE)



04-700 14cm (Cyan)
04-701 16cm (Cyan)
04-702 18cm (Cyan)



04-718 14cm (RED)
04-719 16cm (RED)
04-720 18cm (RED)



04-703 14cm (BLACK)
04-704 16cm (BLACK)
04-705 18cm (BLACK)



04-721 14cm (ROYAL BLUE)
04-722 16cm (ROYAL BLUE)
04-723 18cm (ROYAL BLUE)



04-706 14cm (RED)
04-707 16cm (RED)
04-708 18cm (RED)



04-724 14cm (BLUE)
04-725 16cm (BLUE)
04-726 18cm (BLUE)

DRESSING & TISSUE FORCEPS



Pinzas para tejidos, Pinces à dissection
Pinze per tessuti, Pinze per dissezione

Pinces a tissu, Anatomische pinzetten
Gewebe, Pinzas de disección



Standard Dressing Forceps

- serrated
- 05-01 10.5cm
 - 05-02 11.5cm
 - 05-03 13cm
 - 05-04 14.5cm
 - 05-05 16cm
 - 05-06 18cm
 - 05-07 20cm
 - 05-08 25cm
 - 05-09 30cm

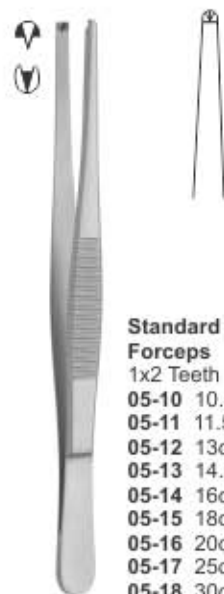

Standard Tissue Forceps

- 1x2 Teeth
- 05-10 10.5cm
 - 05-11 11.5cm
 - 05-12 13cm
 - 05-13 14.5cm
 - 05-14 16cm
 - 05-15 18cm
 - 05-16 20cm
 - 05-17 25cm
 - 05-18 30cm



Mod. USA, Dressing Forceps

- serrated
- 05-19 10.2cm
 - 05-20 12cm
 - 05-21 13cm
 - 05-22 14.5cm
 - 05-23 15.5cm
 - 05-24 18cm
 - 05-25 21cm
 - 05-26 25cm
 - 05-27 31cm



Mod. USA, Tissue Forceps

- 1x2 teeth
- 05-28 10.2cm
 - 05-29 11.4cm
 - 05-30 12.7cm
 - 05-31 14.0cm
 - 05-32 15.2cm
 - 05-33 17.8cm
 - 05-34 20.3cm
 - 05-35 25.4cm
 - 05-36 30.5cm



Mod. Martin Dressing Forceps

- 05-37 12.7cm
- 05-38 14.0cm

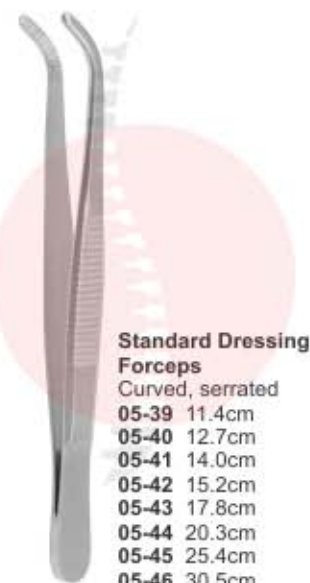

Standard Dressing Forceps

- Curved, serrated
- 05-39 11.4cm
 - 05-40 12.7cm
 - 05-41 14.0cm
 - 05-42 15.2cm
 - 05-43 17.8cm
 - 05-44 20.3cm
 - 05-45 25.4cm
 - 05-46 30.5cm



Standard Dressing Forceps

- wide pattern cross serration
- 05-47 11.4cm
 - 05-48 12.7cm
 - 05-49 14.0cm
 - 05-50 15.20cm
 - 05-51 17.8cm
 - 05-52 20.3cm
 - 05-53 25.4cm
 - 05-54 30.5cm



Standard Dressing Forceps

- Narrow Point serrated
- 05-55 12.7cm
 - 05-56 14 cm
 - 05-57 15.20cm
 - 05-58 17.8cm
 - 05-59 20.3cm
 - 05-60 25.4cm
 - 05-61 30.5cm



Semken Dressing Forceps

- Straight Serrated
- 05-62 12.5cm
 - 05-63 15.5cm



Semken Dressing Forceps

- Curved Serrated
- 05-64 12.5cm
 - 05-65 15.5cm



Potts-Smith Dressing Forceps

- Straight Serrated
- 05-66 17.5cm
 - 05-67 21cm
 - 05-68 25 cm



Potts-Smith Dressing Forceps

- Curved Serrated
- 05-69 17.5cm
 - 05-70 21cm
 - 05-71 25cm

Pinces a tissu, Anatomische pinzetten | Pinzas para tejidos, Pinces à dissection
Gewebe, Pinzas de disección | Pinze per tessuti, Pinze per dissezione



Potts-Smith Tissue Forceps
 1x2 teeth Straight
 05-72 17.5cm
 05-73 21.0cm
 05-74 25.0cm



Potts-Smith Tissue Forceps
 1x2 teeth Curved
 05-75 17.5cm
 05-76 21.0cm
 05-77 25.0cm



Brophy Dressing Forceps
 Straight Serrated
 05-78 20cm



Brophy Dressing Forceps
 Curved Serrated
 05-79 20cm



Brophy Tissue Forceps
 1x2 teeth
 Straight Serrated
 05-80 20cm

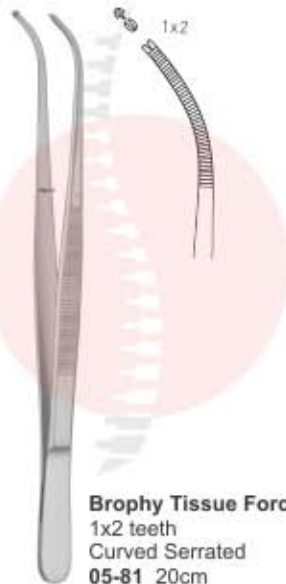

Brophy Tissue Forceps
 1x2 teeth
 Curved Serrated
 05-81 20cm



Wangensteen Dressing Forceps
 05-82 23cm



Stone Tissue Forceps
 4X5 Teeth
 05-83 15.2cm

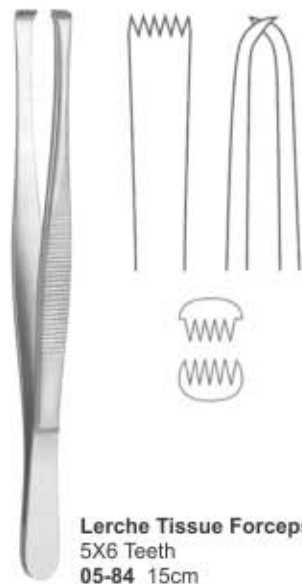

Lerche Tissue Forceps
 5X6 Teeth
 05-84 15cm

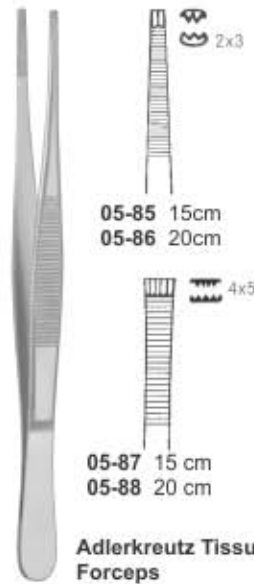

05-85 15cm
 05-86 20cm
 05-87 15 cm
 05-88 20 cm
Adlerkreutz Tissue Forceps

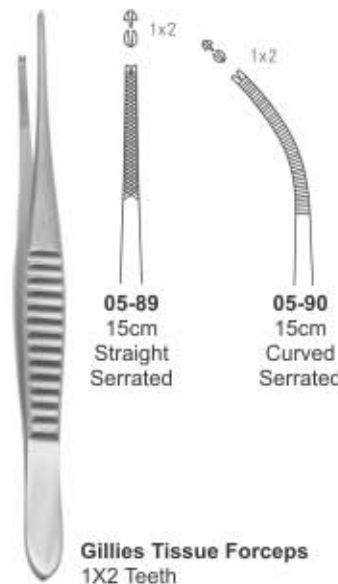

05-89 15cm
 Straight Serrated
 05-90 15cm
 Curved Serrated
Gillies Tissue Forceps
 1X2 Teeth



Treves Tissue Forceps
 1x2 Teeth
 05-91 12.5cm
 05-92 15cm
 05-93 18cm
 Dissecting Forceps
 teeth, on smooth jaws.

Pinzas para tejidos, Pincas à dissection
Pinze per tessuti, Pinze per dissezione

Pincas a tissu, Anatomische pinzetten
Gewebe, Pinzas de disección



Tissue Forceps
2x3 Teeth
05-94 11.4cm
05-95 13.0cm
05-96 14.5cm
05-97 16.0cm
05-98 17.5cm
05-99 20.0cm
05-100 25.0cm
05-101 30.0cm



Tissue Forceps
3x4 Teeth
05-102 11.4cm
05-103 13.0cm
05-104 14.5cm
05-105 16.0cm
05-106 17.5cm
05-107 20.0cm
05-108 25.0cm
05-109 30.0cm



Tissue Forceps
4x5 Teeth
05-110 11.4cm
05-111 13.0cm
05-112 14.5cm
05-113 16.0cm
05-114 17.5cm
05-115 20.0cm
05-116 25.0cm
05-117 30.0cm



Iris Tissue Forceps
1x2 Teeth, Straight
05-118 10.2 cm



Iris Tissue Forceps
1x2 Teeth, Half Curved
05-119 10.2 cm



Iris Tissue Forceps
1x2 Teeth, Full Curved
05-120 10.2 cm



Iris Forceps
05-121
10cm



Iris Tissue Forceps
1x2 teeth
05-122 10cm



Waugh Dressing Forceps
05-123 15 cm
05-124 18 cm
slightly heavier
non-toothed,
serrated jaws.



Waugh Tissue Forceps
1x2 Teeth
05-125 15 cm
05-126 18 cm
as above but one two
tooth on serrated jaws.
Known as Scott.



Leedham Tissue Forceps
1x2 Teeth
05-127 14.5 cm
05-128 18 cm
Green Dissecting
Forceps two three
teeth, smooth jaws.



Charnley Tissue Forceps
1x2 Teeth
05-129 14.5cm
05-130 18.0cm
Dissecting Forceps
one into two teeth,
block on jaws.

Pinzas para tejidos, Pinces à dissection
Pinze per tessuti, Pinze per dissezione

Pinces a tissu, Anatomische pinzetten
Gewebe, Pinzas de disección



Ramsay Dissecting Forceps
05-131 18cm
serrated jaws.



Ramsay Tissue Forceps
Dissecting Forceps
one into teeth on
serrated jaws.

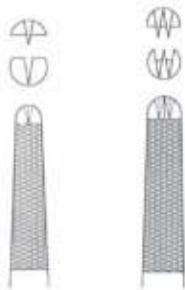

05-132 18cm
1x2 teeth
05-133 18cm
2x3 teeth



Dissecting Dressing Forceps
05-134 12.5cm
05-135 15.0cm
05-136 18.0cm
turn over end, serrated jaws.



Dissecting Dressing Forceps
05-137 12.5cm
05-138 15.0cm
05-139 18.0cm
05-140 20.0cm
block end, serrated jaws.



Ferris-Smith Tissue Forceps
1x2 Teeth
05-141 18cm



Ferris-Smith Tissue Forceps
2x3 Teeth
05-142 18cm



Lane Tissue Forceps
1x2 Teeth
05-143 12.5cm
05-144 15cm
05-145 17cm
05-146 18cm
05-147 20cm



Lane Tissue Forceps
2x3 Teeth
05-148 12.5cm
05-149 15cm
05-150 17cm
05-151 18cm
05-152 20cm



Bonney Tissue Forceps
1x2 Teeth
05-153 18cm



Bonney Tissue Forceps
2x3 Teeth
05-154 18cm



Durante Tissue Grasping Forceps
05-155 14.5cm
05-156 16cm
05-157 20cm

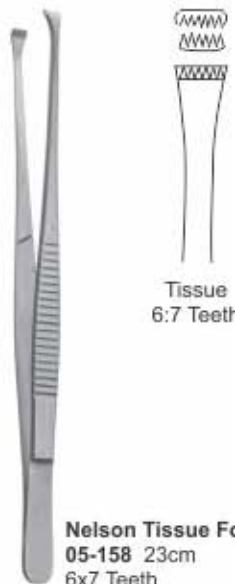

Nelson Tissue Forceps
05-158 23cm
6x7 Teeth



MANZIM SURGICO

Pinzas para tejidos, Pincas à dissection | Pincas a tissu, Anatomische pinzetten
Pinze per tessuti, Pinze per dissezione | Gewebe, Pinzas de disección

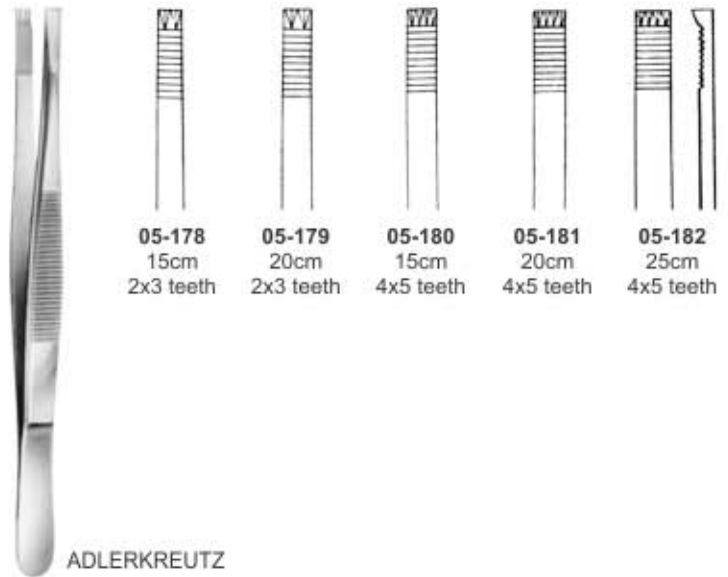
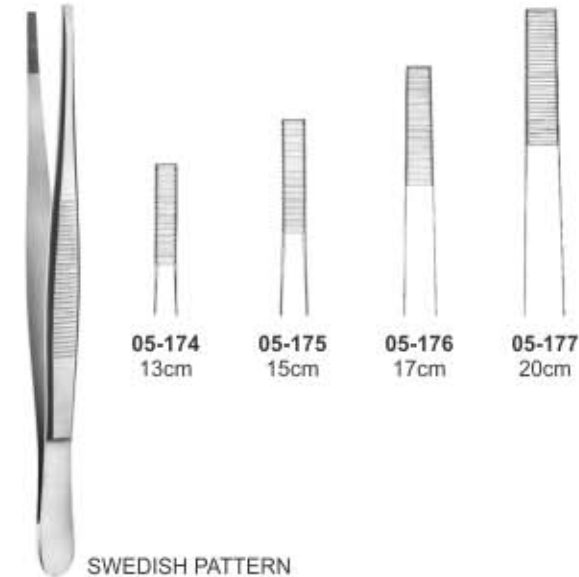
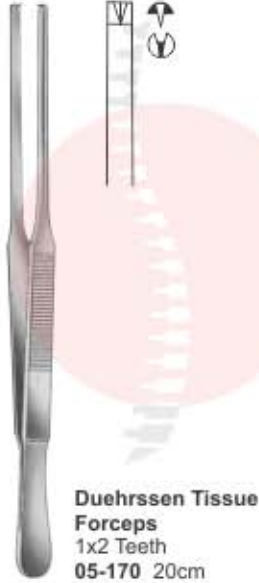
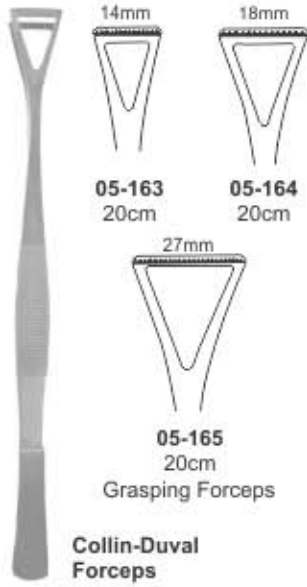

Pinzas para tejidos, Pincas à dissection
Pinze per tessuti, Pinze per dissezione

Pincas a tissu, Anatomische pinzetten
Gewebe, Pinzas de disección

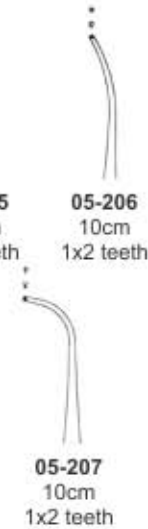
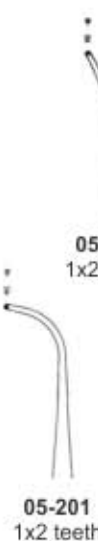
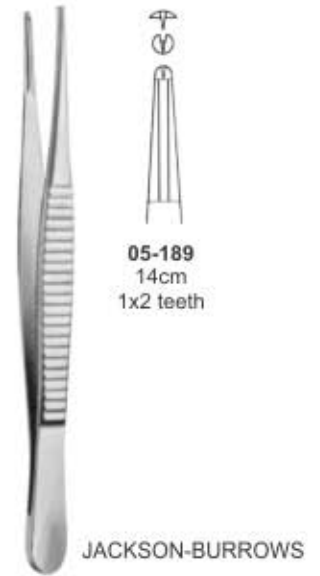
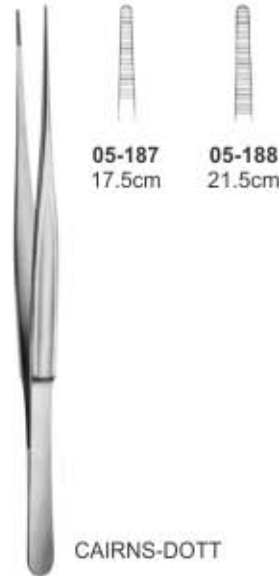
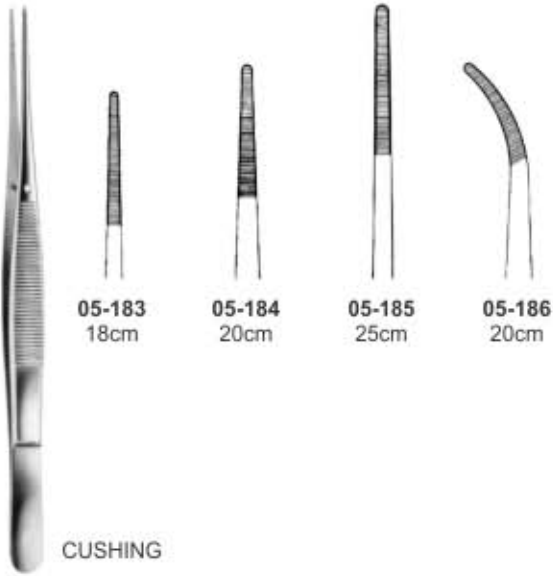

Pinzas para tejidos, Pinces à dissection
Pinze per tessuti, Pinze per dissezione

Pinces a tissu, Anatomische pinzetten
Gewebe, Pinzas de disección

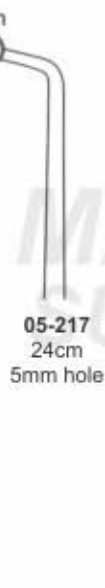
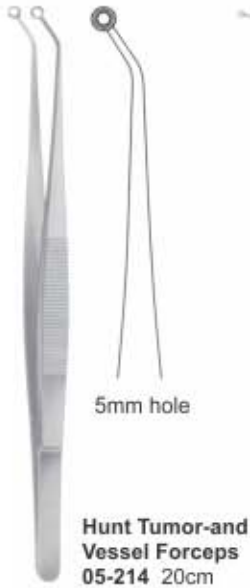

Pinzas para tejidos, Pincas à dissection
Pinze per tessuti, Pinze per dissezione

Pincas a tissu, Anatomische pinzetten
Gewebe, Pinzas de disección



Yasargil
05-231
20cm



Hunt
05-232
20cm



Hunt
05-233
20cm



Plain Forceps
05-234 18.5cm



Jansen
05-235 16 cm
05-236 18 cm
05-237 20 cm



Plain Forceps
05-238 16cm



Tissue Forceps
05-239 16cm

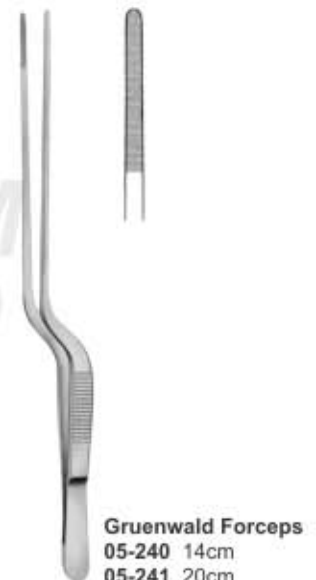

Gruenwald Forceps
05-240 14cm
05-241 20cm



Gruenwald Tissue Forceps
05-242 20cm

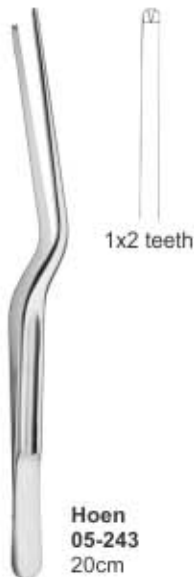

Hoen
05-243
20cm



D'Errico
05-244
22cm



D'Errico
05-245
22cm

Pinzas para tejidos, Pincas à dissection
Pinze per tessuti, Pinze per dissezione

Pincas a tissu, Anatomische pinzetten
Gewebe, Pinzas de disección



Adson
05-246
23cm



Troeltsch
05-247 10cm
05-248 12cm
05-249 15cm
05-250 17cm



Troeltsch
05-251
13cm



Wilde
05-252
11cm



Troeltsch
05-253
11.5cm



Landolt
05-254
21.5cm



Yasargil

0,6 mm

05-255
18cm
05-256
20 cm
05-257
22 cm
05-258
24 cm

0,9 mm

05-259
18 cm
05-260
20 cm
05-261
22 cm
05-262
24 cm

φ

05-263
18 cm
05-264
20 cm
05-265
22 cm
05-266
24 cm
1x2 teeth



YASARGIL
22 cm



05-267



05-268



YASARGIL
22 cm



05-269



05-270



YASARGIL
24 cm



05-271



05-272



05-273

Pinces a tissu, Anatomische pinzetten
Gewebe, Pinzas de disección

Pinzas para tejidos, Pinces à dissection
Pinze per tessuti, Pinze per dissezione

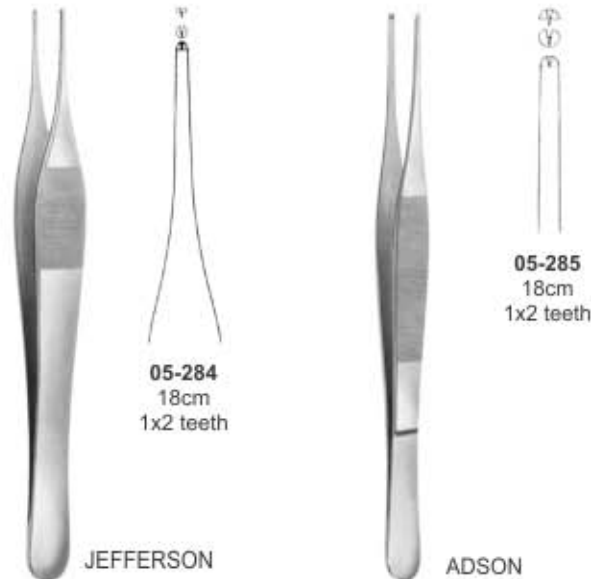
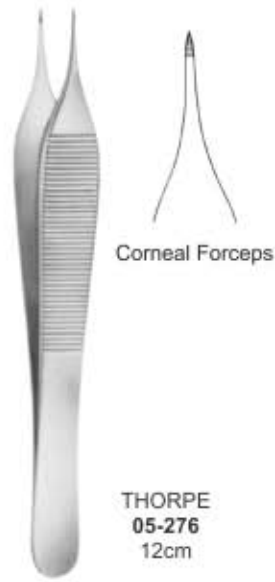
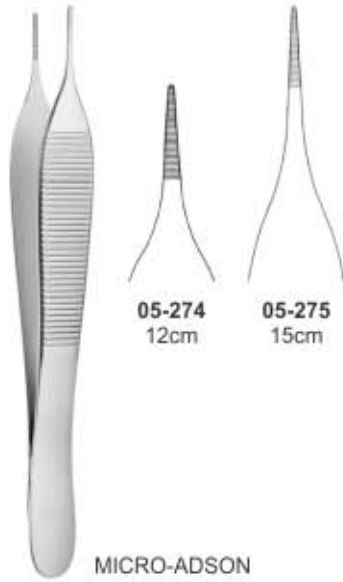

Pincas a tissu, Anatomische pinzetten
Gewebe, Pinzas de disección

Pinzas para tejidos, Pincas à dissection
Pinze per tessuti, Pinze per dissezione

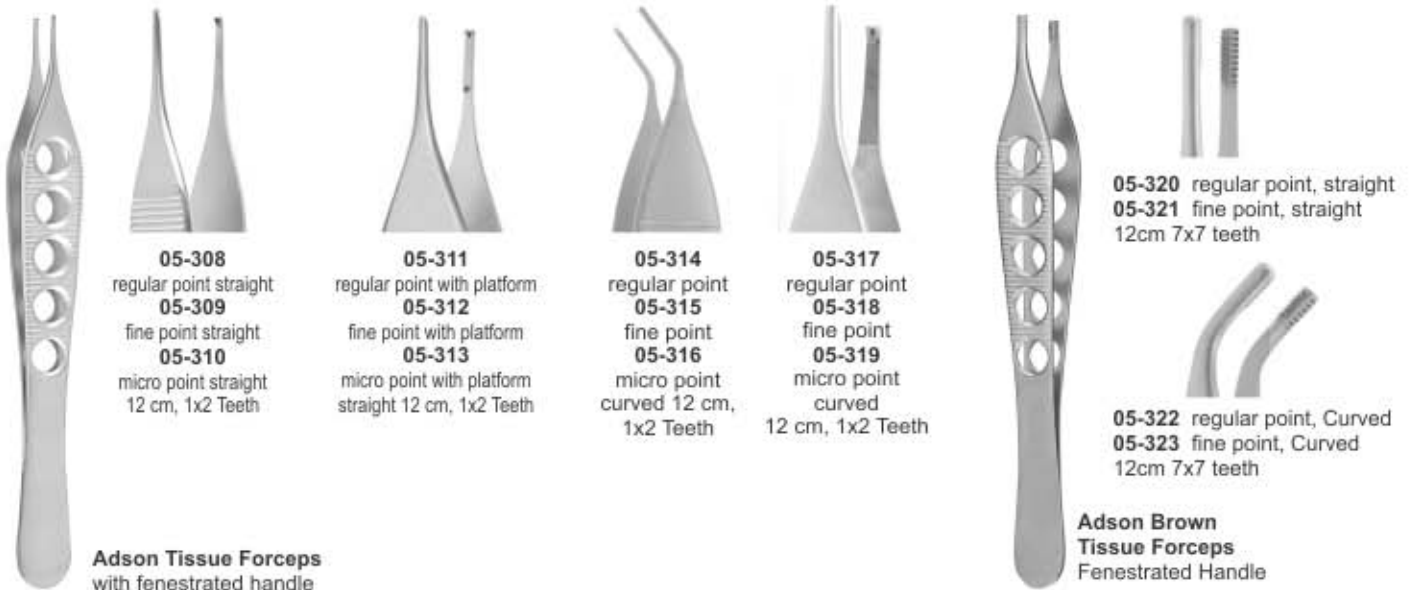
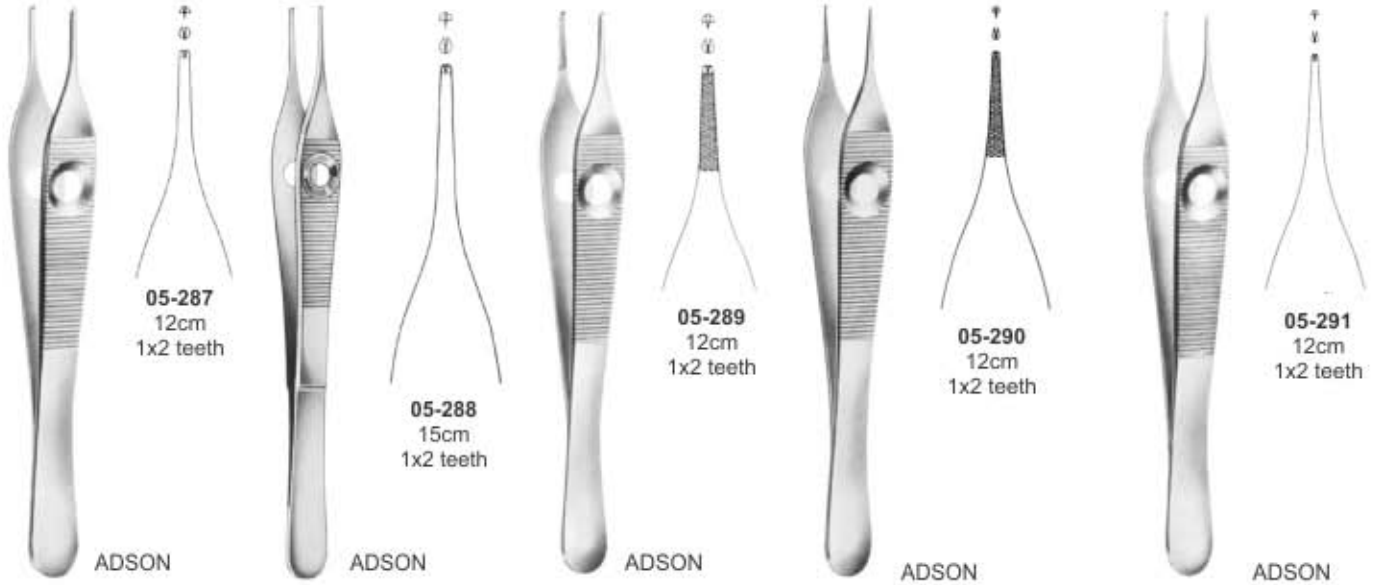

Pinces a tissu, Anatomische pinzetten | *Pinzas para tejidos, Pinces à dissection*
Gewebe, Pinzas de disección | *Pinze per tessuti, Pinze per dissezione*



Graefe Forceps

05-324
7cm
05-325
10cm
straight
serrated



05-326
7cm
05-327
10cm
half curved
serrated



05-328
7cm
05-329
10cm
full curved
serrated



05-330
7cm
05-331
10cm
1x2 teeth
straight



05-332
7cm
05-333
10cm
1x2 teeth
half curved



05-334
7cm
05-335
10cm
1x2 teeth
full curved



Stevens Tissue Forceps
1x2 Teeth

05-336
11cm
straight



Stevens Tissue Forceps
1x2 Teeth

05-337
11cm
Curved



Graefe Dressing Forceps
05-338 0.5 mm
05-339 0.7 mm
05-340 1.0 mm
7cm
Straight Serrated



Graefe Dressing Forceps
05-341 0.5 mm
05-342 0.7 mm
05-343 1.0 mm
7cm
curved serrated



Graefe Tissue Forceps
1x2 Teeth
05-344 0.5 mm
05-345 0.7 mm
05-346 1.0 mm
7cm Straight



Graefe Tissue Forceps
1x2 Teeth
05-347 0.5 mm
05-348 0.7 mm
05-349 1.0 mm
7cm Curved



Graefe Fixation Forceps
05-350 11.2 cm
standard jaws 4.5mm wide
with fine teeth



05-351
90mm
05-352
105mm
05-353
115mm
05-354
125mm

Chirurgische pinzetten, Uhrmacher-Pinzetten
Pinzas de disección con dientes, Pinzas de relojero

Pinces à dissection à groffes, Pinces d'horloger
Pinze per dissezione con denti, Pinze de orologiaio



Dumont Forceps
05-355 11.5cm
curved



05-356
10.5cm
full curved



05-357
10.5cm
half curved



05-358
11cm



05-359
11cm
fine point



05-360
11cm
extra fine
point



05-361
12cm
fine point



05-362
12cm
extra fine
point



05-363
12cm



Dumont Forceps
05-364
style 1, fine point,
12cm



Dumont Forceps
05-365
style 2, strong
fine point,
12cm



Dumont Forceps
05-366
style 3, narrow
fine point,
12cm



Dumont Forceps
05-367
style 3C, narrow
fine point,
11cm



Dumont Forceps
05-368
style 4, fine point,
11cm



Dumont Forceps
05-369
style 5, super fine
11cm point



Dumont Forceps
05-370
style 5, micro fine
11cm point



Dumont Forceps
05-371
style 7, micro fine
11.5 cm curved



Dumont Forceps
05-372
style 7, fine curved,
11.5 cm



Dumont Forceps
05-373
style 6, pick up,
11.5 cm

CILIA FORCEPS

Cilienpinzetten

Pinces à épiler les cils

Pinzas depilatorias

Pinze depilatoria



Ziegler Cilia Forceps
05-374 9cm



Beer Cilia Forceps
05-375 9cm



Douglas Cilia Forceps
05-376 9cm



Gradle Cilia Forceps
05-377 10.5cm



Kuehne Cilia Forceps
05-378 10.5cm

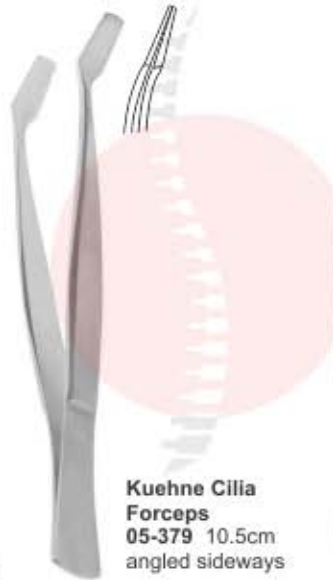

Kuehne Cilia Forceps
05-379 10.5cm
angled sideways



Barraquer Cilia Forceps
05-380 10.5cm



Littauer Cilia Forceps
05-381 8.5cm



Littauer Cilia Forceps
05-382 9cm



Splinter Forceps
05-383 8 cm
05-384 9 cm
05-385 10.5cm
05-386 11.5cm
05-387 12.5cm
05-388 14.5cm
Straight Plain



Splinter Forceps
05-389 8cm
05-390 9cm
05-391 10.5cm
05-392 11.5cm
05-393 12.5cm
05-394 14.5cm
Curved Plain



Splinter Forceps
05-395 8cm
05-396 9cm
05-397 10.5cm
05-398 11.5cm
05-399 12.5cm
05-400 14.5cm
Straight serrated



Splinter Forceps
05-401 8cm
05-402 9cm
05-403 10.5cm
05-404 11.5cm
05-405 12.5cm
05-406 14.5cm
Curved serrated



Feilchenfeld Forceps
05-407 7.5cm
05-408 9cm
05-409 11cm
Straight

SPLINTER FORCEPS

Splitterpinzetten
Pinzas Para espinas

Pinces à échardes
Pinze per scheggie



05-410
10.5cm
Straight

Hunter Forceps



05-411
10.5cm
Curved

Hunter Forceps



05-412
10.5cm
Straight

Carmalt Forceps



05-413
10.5cm
Curved

Carmalt Forceps



Splinter Forceps
05-414 8cm
05-415 9cm
05-416 10.5cm
05-417 11.5cm
05-418 12.5cm
05-419 14.5cm
Straight serrated with guide pin



Splinter Forceps
05-420 8cm
05-421 9cm
05-422 10.5cm
05-423 11.5cm
05-424 12.5cm
05-425 14.5cm
Curved serrated with guide pin



Splinter Forceps
05-426 8cm
05-427 9cm
05-428 10.5cm
05-429 11.5cm
05-430 12.5cm
05-431 14.5cm
Straight plain with guide pin



Splinter Forceps
05-432 8cm
05-433 9cm
05-434 10.5cm
05-435 11.5cm
05-436 12.5cm
05-437 14.5cm
Curved plain with guide pin



Stieglitz Forceps with Magnifying Mirrors
05-438 12.5cm



Ochsner Forceps
05-439 14cm



Lange Tissue Forceps
05-440 10cm



Childe Tissue Forceps
05-441 18cm



Michel Tissue Forceps
05-442 12cm



Wachenfeldt Tissue Forceps
05-443 12.5cm



Hegenbarth Tissue Forceps
05-444 12.5cm

Splitterpinzetten | Pincès à écharde
 Pinzas Para espinas | Pinze per scheggie



**Wachenfeldt
Tissue Forceps**
05-445 12.5cm



Stieglitz Splinter Forceps
05-446 14cm Str.
05-447 14cm 45° Angled



Stieglitz Splinter Forceps
05-448 14cm, 90° Angled



Peet Splinter Forceps
05-449 11.5cm

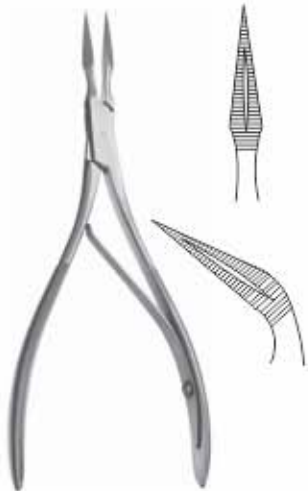

Raik Splinter Forceps
05-450 15cm, Str.
05-451 15cm, Cvd.



Michel Clips
05-453
sizes: 11mm x 3mm
& 18mm x 3mm.



Mod. Michel Forceps
05-454 12cm



Collin Forceps
05-455 13cm



Richter-Heath Forceps
05-456 14cm



1.5 mm
05-457 14cm

T.C Oehler Tissue Forceps



2.0 mm
05-458 16cm



2.7 mm
05-459 18cm



0.4 mm
05-463 15cm

**Semken
with dissector
end**



0.2 mm
05-464 16cm

**Semken
1x2 teeth**



0.2 mm
05-465 18cm

**T.C De Bakey
Dressing Forceps**
05-466 15cm
05-467 19cm
05-468 24cm



1.5 mm
05-466 15cm



2.0 mm
05-467 19cm



0.4 mm
05-468 24cm

**T.C Gillies
Tissue Forceps**
05-469 15cm

Pinces a tissu, Anatomische pinzetten
Gewebe, Pinzas de disección

Pinzas para tejidos, Pinces à dissection
Pinze per tessuti, Pinze per dissezione

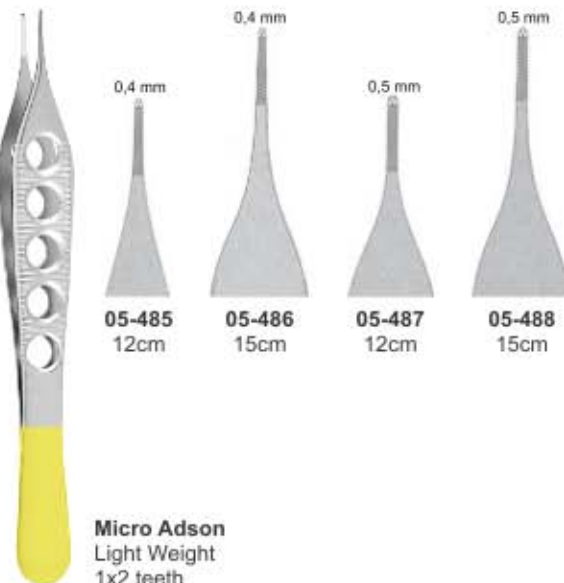
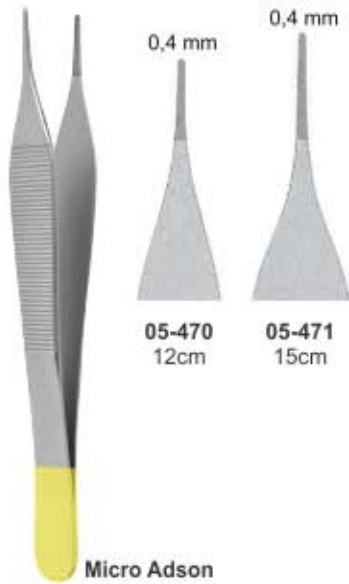

Pinces a tissu, Anatomische pinzetten | *Pinzas para tejidos, Pincas à dissection*
Gewebe, Pinzas de disección | *Pinze per tessuti, Pinze per dissezione*

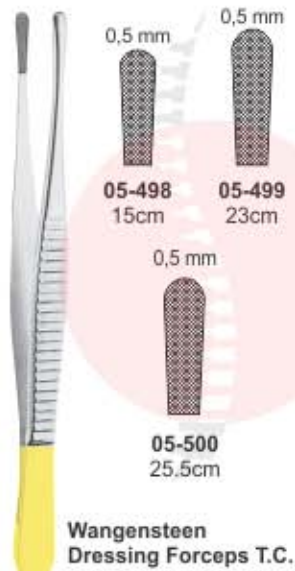

HAEMOSTATIC FORCEPS



Arterienklemmen
Pincas Hemostaticas

Pinzas Hemostaticas
Pinze Emostatiche



Mosquito Haemostatic Forceps



06-01
11.3cm
straight,
serrated



06-02
11.3cm
Curved,
Serrated

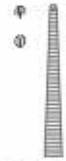

06-03 11.3cm
Straight
Haemostatic tissue
(rat tooth 1x2 teeth)



06-04 11.3cm
Curved
Haemostatic tissue
(rat tooth 1x2 teeth)



Halsted-Mosquito Haemostatic Forceps



06-05
12.5cm
06-06
20cm
straight



06-07
12.5cm
06-08
20cm
curved



Halsted-Mosquito Haemostatic Forceps

06-09
12.5cm
06-10
20cm
straight
Left Handed

06-11
12.5cm
06-12
20cm
curved
Left Handed



Kelly Haemostatic Forceps

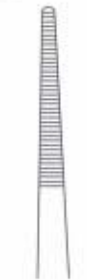

06-13
14cm
straight



06-14
14cm
curved



06-15
Kelly Haemostatic Fine
point Forceps 14cm
straight



06-16
Kelly Haemostatic Fine
point Forceps 14cm
curved

HAEMOSTATIC FORCEPS

Arterienklemmen
Pincas Hemostatiques

Pinzas Hemostaticas
Pinze Emostatiche



**Dandy Haemostatic
Fine point Forceps**
06-18 14cm
Curved sideways

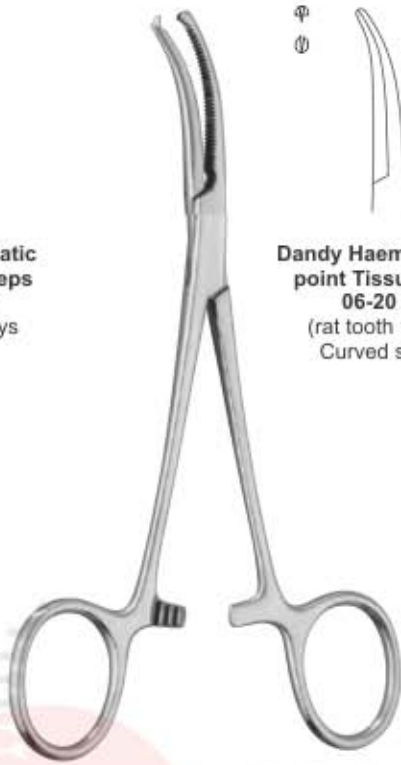

**Dandy Haemostatic Fine
point Tissue Forceps**
06-20 14cm
(rat tooth 1x2 teeth)
Curved sideways

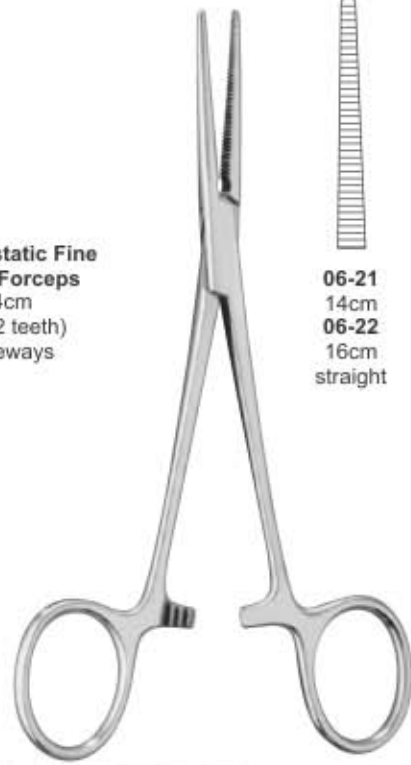

06-21
14cm
06-22
16cm
straight



06-23
14cm
06-24
16cm
curved

Dandy Haemostatic Forceps
06-17 14cm
Curved sideways

**Dandy Haemostatic
Tissue Forceps**
06-19 14cm
(rat tooth 1x2 teeth)
Curved sideways

Crile Haemostatic Forceps

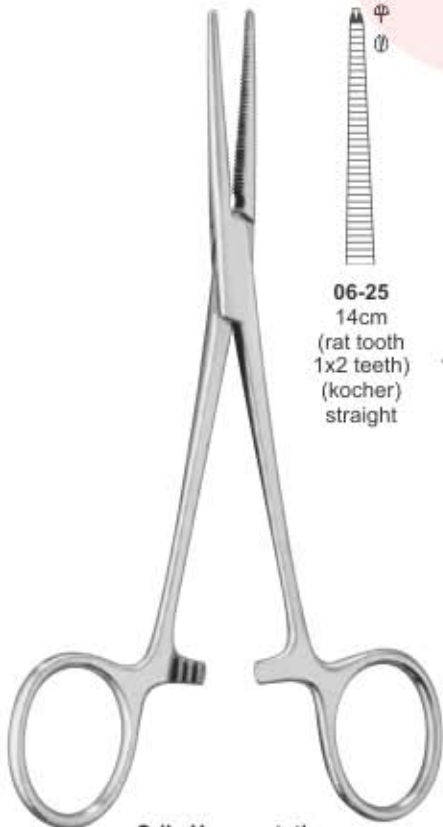

06-25
14cm
(rat tooth
1x2 teeth)
(kocher)
straight

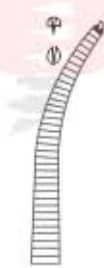

06-26
14cm
(rat tooth
1x2 teeth)
(kocher)
curved

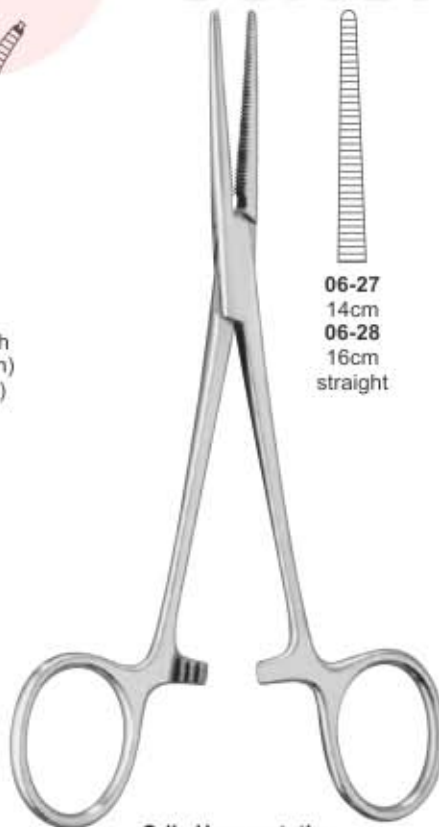

06-27
14cm
06-28
16cm
straight



06-29
14cm
06-30
16cm
curved

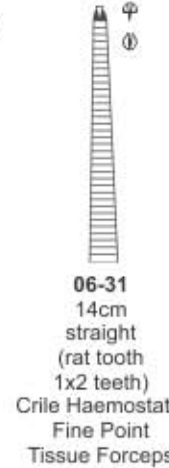

06-31
14cm
straight
(rat tooth
1x2 teeth)
Crile Haemostatic
Fine Point
Tissue Forceps

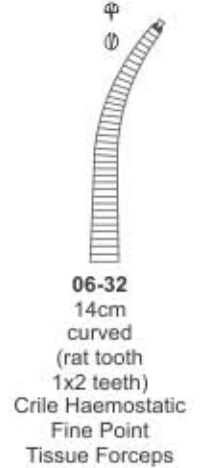

06-32
14cm
curved
(rat tooth
1x2 teeth)
Crile Haemostatic
Fine Point
Tissue Forceps

**Crile Haemostatic
Tissue Forceps**

**Crile Haemostatic
Fine Point Forceps**

Arterienklemmen
Pincas Hemostaticas

Pinzas Hemostaticas
Pinze Emostatiche

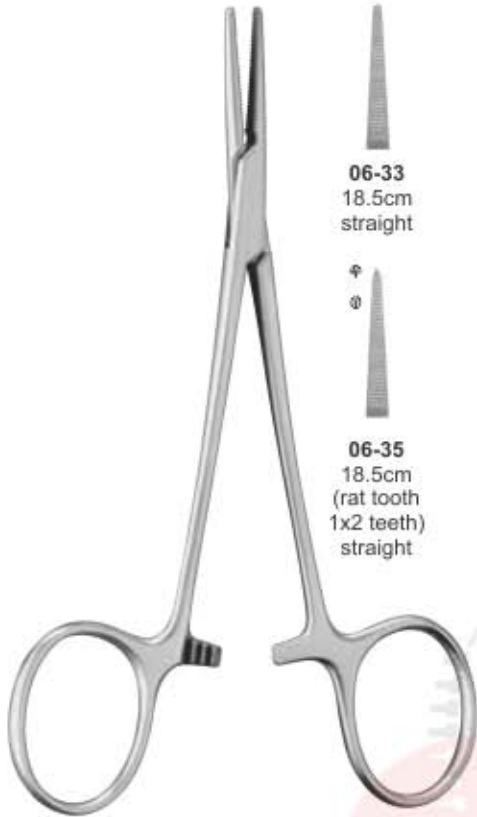

06-33
18.5cm
straight

06-34
18.5cm
curved



06-35
18.5cm
(rat tooth
1x2 teeth)
straight



06-36
18.5cm
(rat tooth
1x2 teeth)
curved

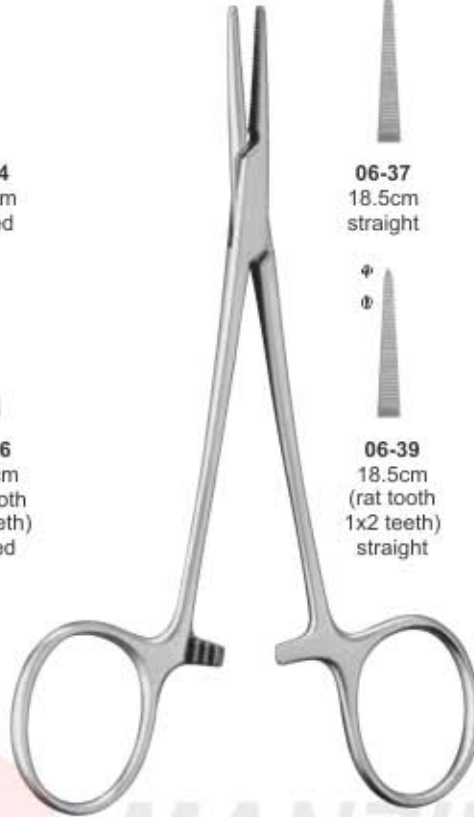

06-37
18.5cm
straight

06-38
18.5cm
curved



06-39
18.5cm
(rat tooth
1x2 teeth)
straight



06-40
18.5cm
(rat tooth
1x2 teeth)
curved



Packer Mosquito Forceps
06-41 12.7cm
Curved, flat jaws



06-42
14cm
06-43
16cm
Straight,
serrated

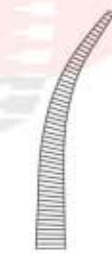

06-44
14cm
06-45
16cm
Curved,
serrated

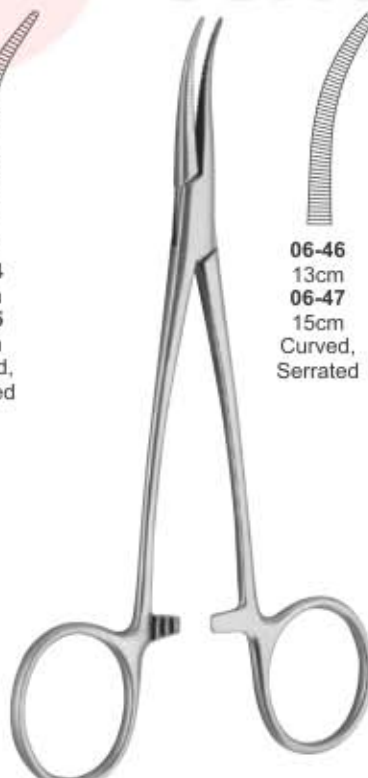

06-46
13cm
06-47
15cm
Curved,
Serrated



06-48
24cm
Straight,
Serrated

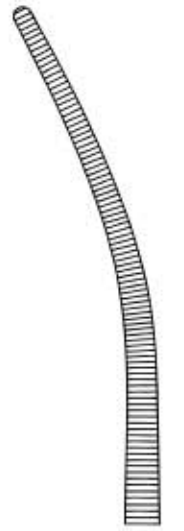

06-49
24cm
Curved
Serrated

Coller Haemostatic Forceps

Christophe Haemostatic Forceps

Saroot Haemostatic Forceps

HAEMOSTATIC FORCEPS

Arterienklemmen
Pincas Hemostatiques

Pinzas Hemostaticas
Pinze Emostatiche



06-50
18.5cm
straight

06-51
18.5cm
curved



06-52
18.5cm
straight
(rat tooth
1x2 teeth)

06-53
18.5cm
Curved
(rat tooth
1x2 teeth)



06-54
15cm
06-55
20cm
Curved

06-56
15cm
06-57
20cm
Curved
Fine Point

Adson Haemostatic Fine point Forceps

Adson Haemostatic Tissue Forceps

O'Shaughnessy Haemostatic Forceps

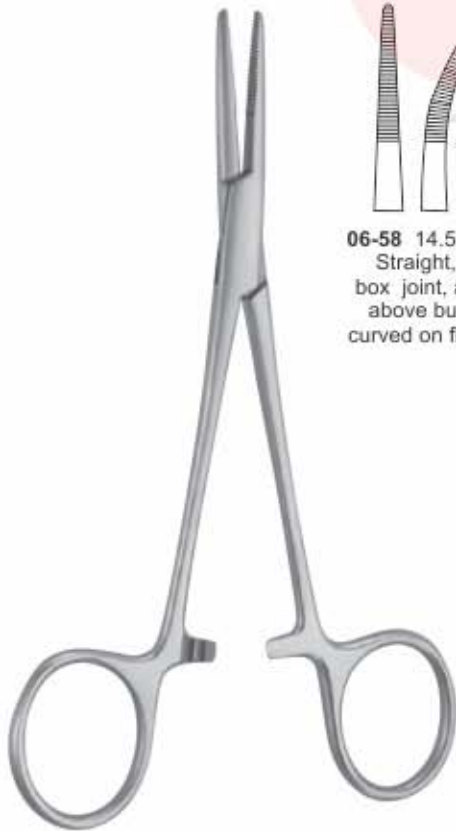

06-58 14.5cm
Straight,
box joint, as
above but
curved on flat.



06-59
13cm
06-60
14cm
straight

06-61
13cm
06-62
14cm
curved



06-63
14.5cm
Straight

Cairns Haemostatic Forceps

Pean Haemostatic Forceps Slender Type

Kocher Haemostatic Forceps Strong Pattern

Arterienklemmen
Pincas Hemostatiquas

Pinzas Hemostaticas
Pinze Emostatiche

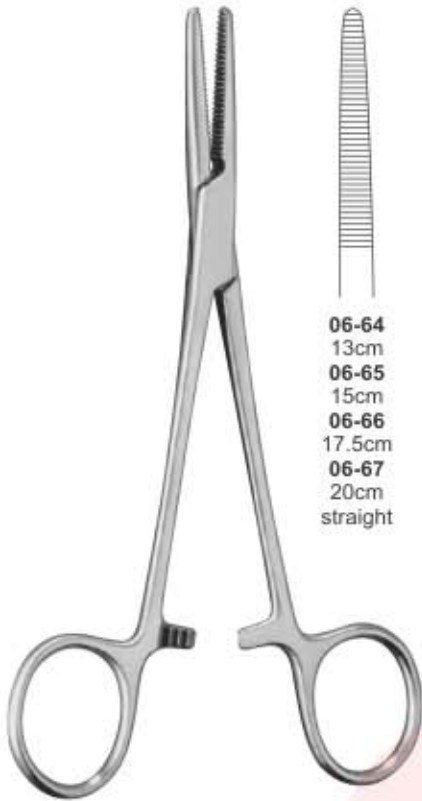

06-64
13cm
06-65
15cm
06-66
17.5cm
06-67
20cm
straight

06-68
13cm
06-69
15cm
06-70
17.5cm
06-71
20cm
curved

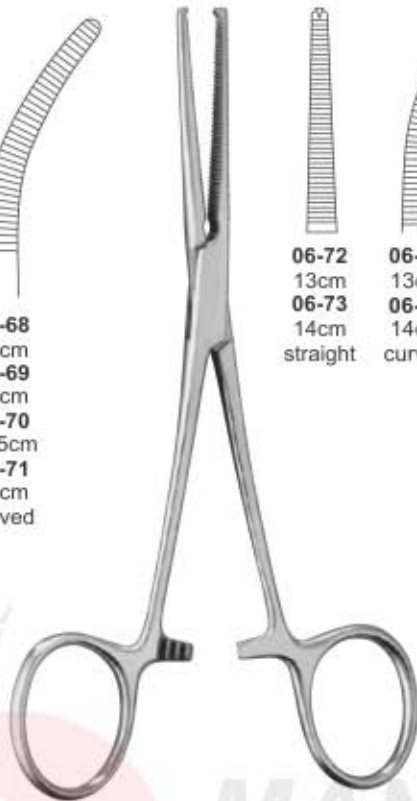

06-72
13cm
06-73
14cm
straight
06-74
13cm
06-75
14cm
curved



06-76
16cm
06-77
20cm
Straight
06-78
16cm
06-79
20cm
Curved

Spencer-Wells Haemostatic Forceps
Slender Type

Kocher Haemostatic Forceps
1x2 teeth

Rochester-Carmalt Haemostatic
Forceps

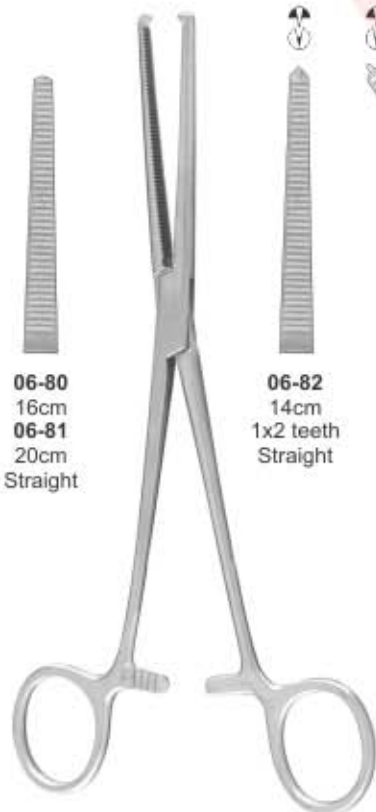

06-80
16cm
06-81
20cm
Straight

06-82
14cm
1x2 teeth
Straight

06-83
14cm
1x2 teeth
Curved

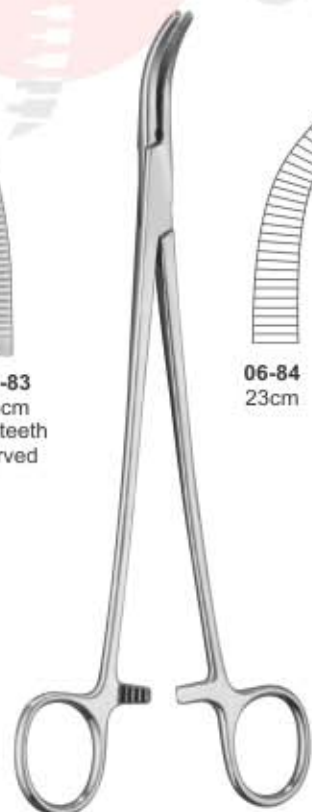

06-84
23cm

06-85
24cm



06-86
19.5cm

06-87
19.5cm

Rochester-Ochsner
Haemostatic Forceps

Moynihan Haemostatic Forceps

Negus Haemostatic Forceps

HAEMOSTATIC FORCEPS

Arterienklemmen
Pinces Hemostatiques

Pinzas Hemostaticas
Pinze Emostatiche



- 06-88 14cm
- 06-89 16cm
- 06-90 18.5cm
- 06-91 20cm
- 06-92 22.5cm
- 06-93 24cm
- 06-94 25.4cm
- 06-95 28cm
- 06-96 30.5cm
- 06-97 35.6cm
- 06-98 40.5cm
- 06-99 45.5cm
- 06-100 50.8cm
- 06-101 55.6cm
- 06-102 60cm
- straight

Rochester-Pean Haemostatic Forceps Straight



- 06-103 14cm
- 06-104 16cm
- 06-105 18.5cm
- 06-106 20cm
- 06-107 22.5cm
- 06-108 24cm
- 06-109 25.4cm
- 06-110 28cm
- 06-111 30.5cm
- 06-112 35.6cm
- 06-113 40.5cm
- 06-114 45.5cm
- 06-115 50.8cm
- 06-116 55.6cm
- 06-117 60cm
- Curved

Rochester-Pean Haemostatic Forceps Curved



- 06-118 18.5cm
- 1x2 teeth

Mikulicz Haemostatic Tissue Forceps



- 06-119 16cm
- 06-120 18.5cm
- 06-121 20cm
- 06-122 22.5cm
- 06-123 24cm
- 06-124 26cm
- Straight
- 1x2 teeth

Kocher-Ochsner Haemostatic Forceps 1x2 teeth

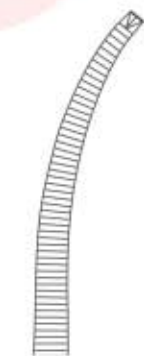

- 06-125 16cm
- 06-126 18.5cm
- 06-127 20cm
- 06-128 22.5cm
- 06-129 24cm
- 06-130 26cm
- Curved
- 1x2 teeth



Rochester-Ochsner Haemostatic Forceps 1x2 teeth



- 06-131 14cm
- 06-132 15cm
- 06-133 16cm
- 06-134 18cm
- 06-135 20cm
- 06-136 22cm
- 06-137 24cm
- 06-138 26cm
- 06-139 28cm
- 06-140 25cm



- 06-141 14cm
- 06-142 15cm
- 06-143 16cm
- 06-144 18cm
- 06-145 20cm
- 06-146 22cm
- 06-147 24cm
- 06-148 26cm
- 06-149 28cm
- 06-150 25cm

Arterienklemmen
Pinces Hemostatiques

Pinzas Hemostaticas
Pinze Emostatiche

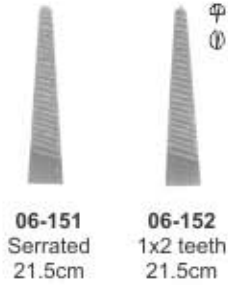

06-151
Serrated
21.5cm

06-152
1x2 teeth
21.5cm

Halsted Haemostatic Forceps

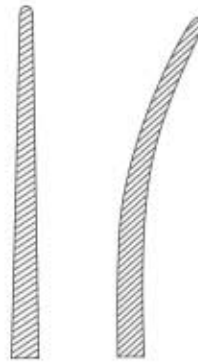
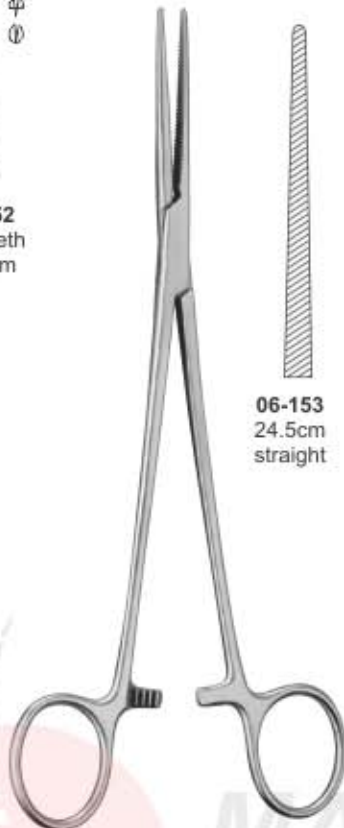

06-153
24.5cm
straight

06-154
24.5cm
Curved

Bengolea Haemostatic Forceps

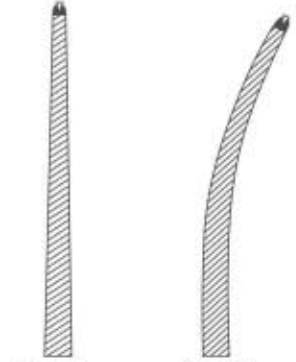
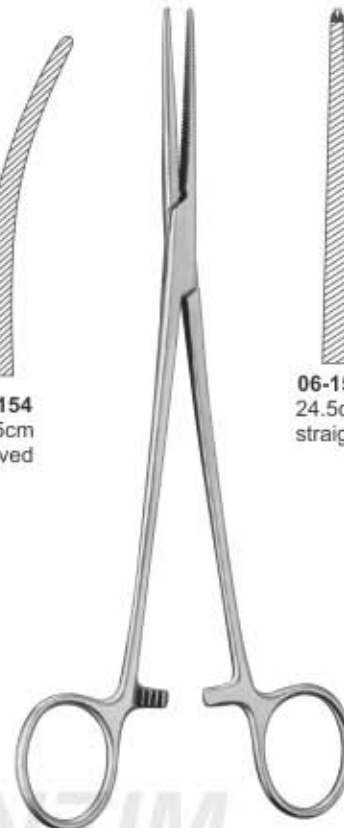

06-155
24.5cm
straight

06-156
24.5cm
Curved

Bengolea Haemostatic Tissue Forceps
(rat tooth 1x2 teeth)



06-157 14cm
06-158 16.5cm
06-159 19cm
06-160 21.5cm
06-161 24cm

Mixer-O'Shaugnessy
Haemostatic Forceps

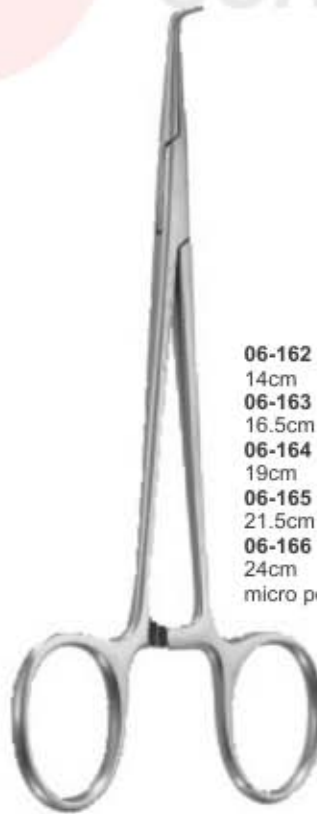

06-162 14cm
06-163 16.5cm
06-164 19cm
06-165 21.5cm
06-166 24cm
micro point

Mixer-O'Shaugnessy
Haemostatic Forceps

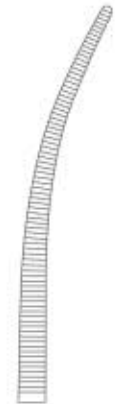
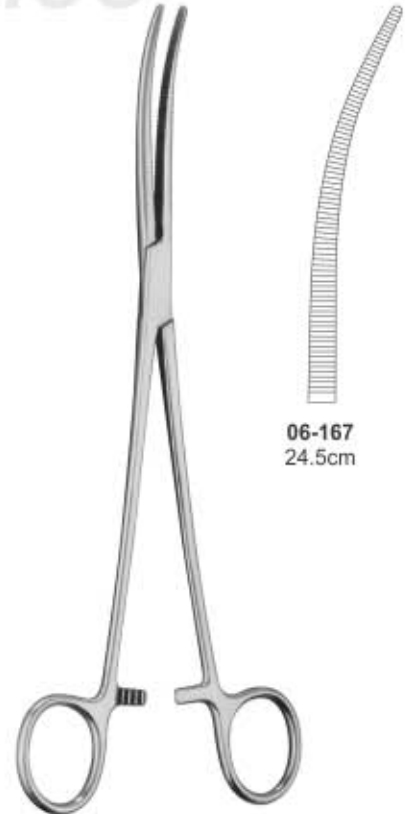

06-167
24.5cm

Crafoord Haemostatic Forceps

HAEMOSTATIC FORCEPS

Arterienklemmen
Pinces Hemostatiques

Pinzas Hemostaticas
Pinze Emostatiche



Herrick Haemostatic Forceps
06-168 23cm

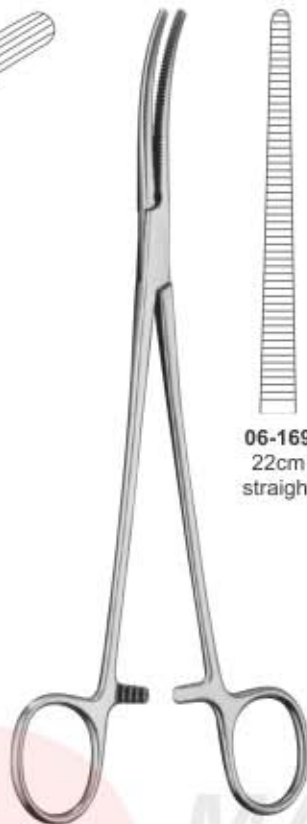

Roberts Haemostatic Forceps

06-169
22cm
straight

06-170
22cm
Curved

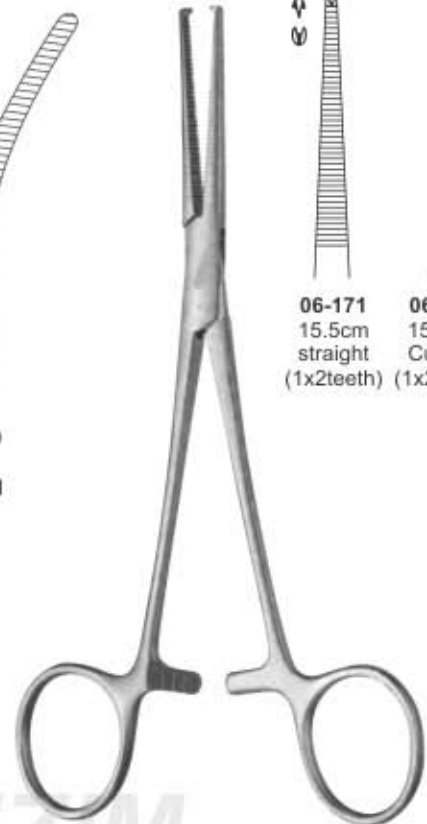

Dixon-Lovelace Haemostatic Tissue Forceps

06-171
15.5cm
straight
(1x2teeth)

06-172
15.5cm
Curved
(1x2teeth)



Craford-Sellors Haemostatic Forceps



06-173
22cm



06-174
23cm



06-175
24cm



Heaney / Ballantine Haemostatic Forceps

06-176
20cm
Straight,
Serrated



06-177
20cm
Slight Curve,
Serrated

HAEMOSTATIC FORCEPS

Arterienklemmen
Pincas Hemostatiques

Pinzas Hemostaticas
Pinze Emostatiche

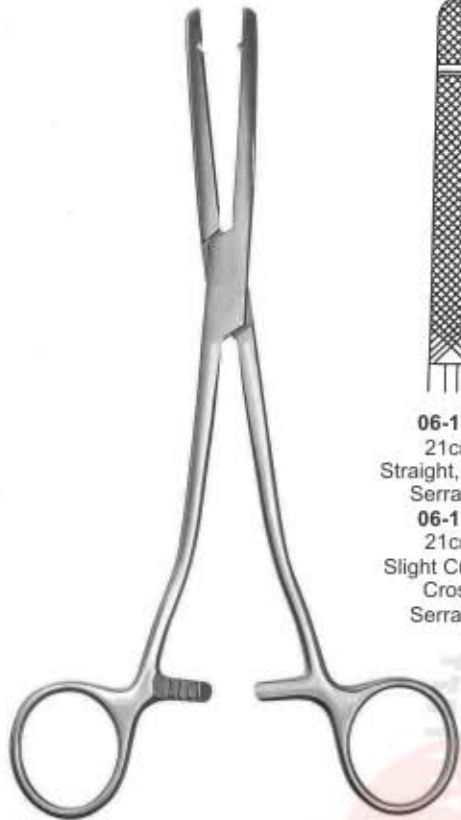

**Heaney / Rezak
Haemostatic Forceps**

06-178
21cm
Straight, Cross
Serrated
06-179
21cm
Slight Curved,
Cross
Serrated



Stille Haemostatic Forceps
06-180 23cm

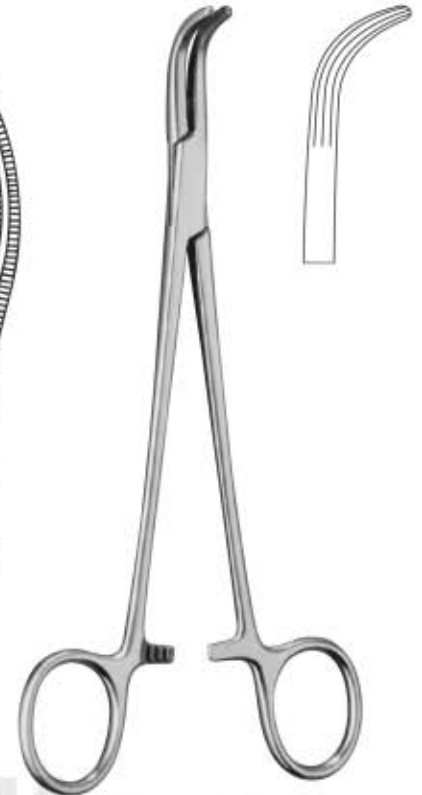

Lower Haemostatic Forceps
06-181 18cm



**Lahey (Sweet)
Haemostatic Forceps**

06-182
19cm
06-183
22cm



**Desjardins Haemostatic
Forceps**
06-184 22cm



**Mixer Haemostatic
Gall Duct Forceps**

06-185
22cm

06-186
25cm

HAEMOSTATIC FORCEPS

Arterienklemmen
Pinces Hemostatiques

Pinzas Hemostaticas
Pinze Emostatiche



**Mixer Forceps,
06-188** 18.4cm
Fully curved,
original model

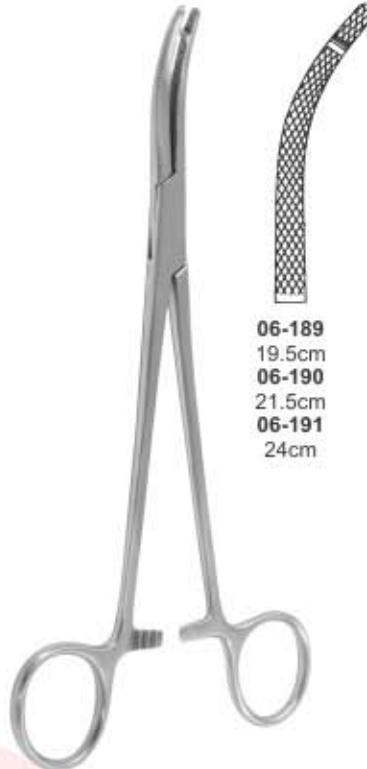

06-189
19.5cm
06-190
21.5cm
06-191
24cm

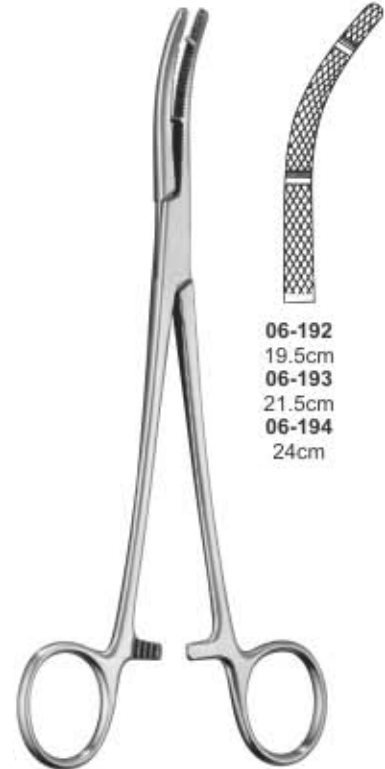

06-192
19.5cm
06-193
21.5cm
06-194
24cm

**Mixer Forceps, Lee Modif
06-187** 13.3cm
Curved jaws and angled
shanks, delicate

Heaney Haemostatic Forceps

**Heaney Modif. Haemostatic
Forceps**

MANZIM
SURGICO

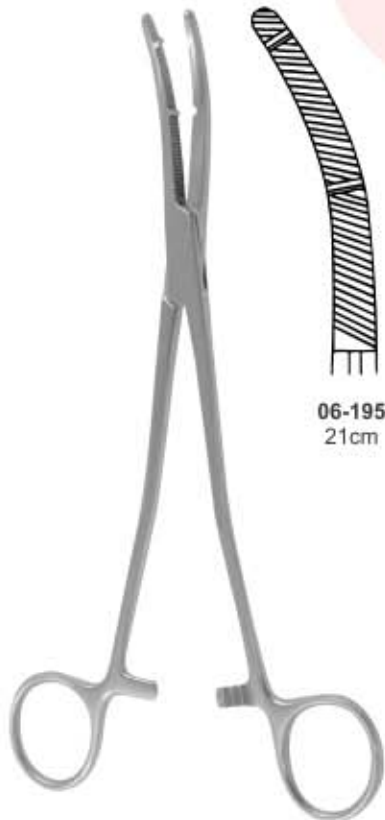

06-195
21cm

**Heaney-Kanter
Haemostatic Forceps**

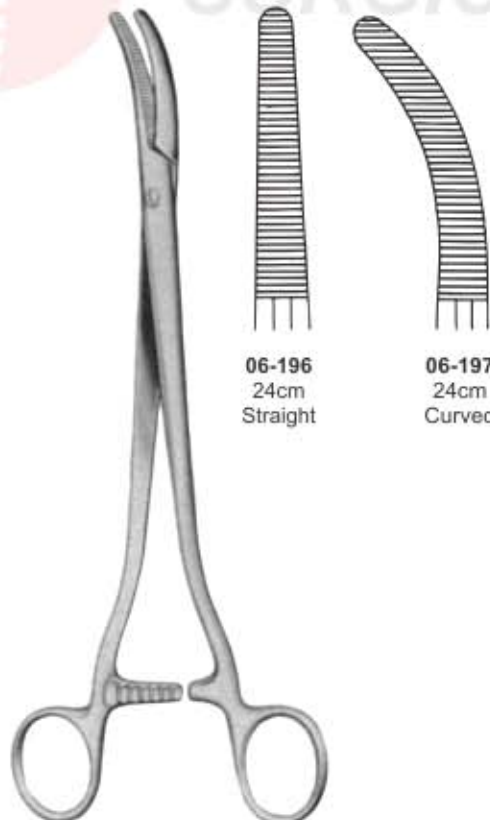

06-196
24cm
Straight

06-197
24cm
Curved

**Segond-Landau
Haemostatic Forceps**

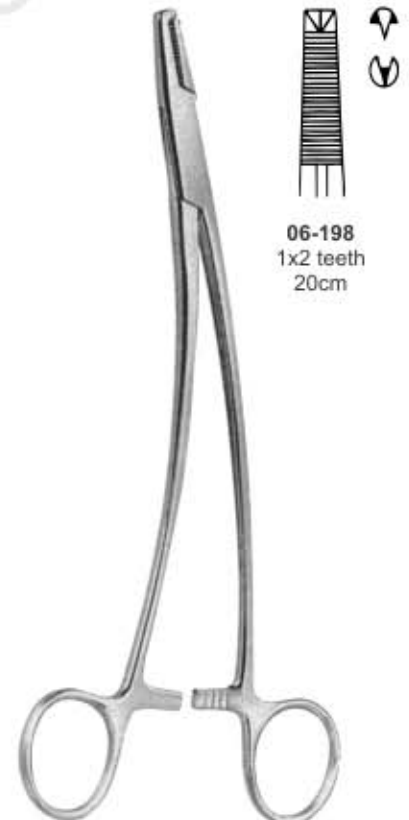

06-198
1x2 teeth
20cm

**Schindler Haemostatic Tissue
Forceps**

Arterienklemmen
Pincas Hemostaticas

Pinzas Hemostaticas
Pinze Emostatiche



Parametrium Haemostatic Forceps

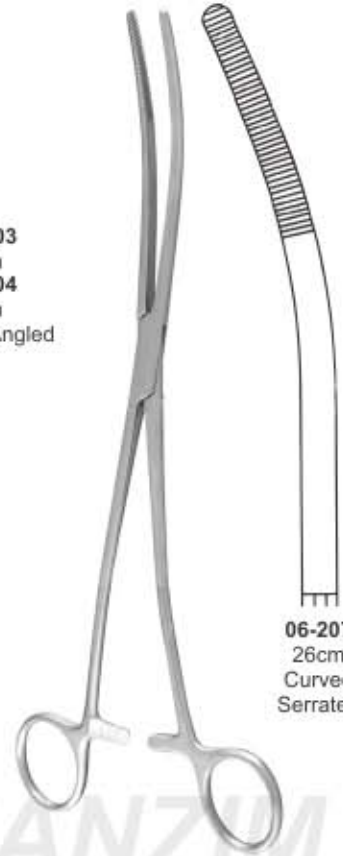
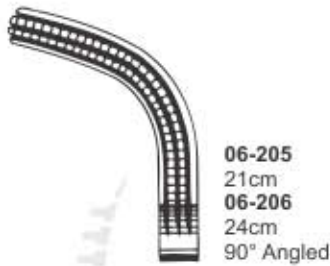
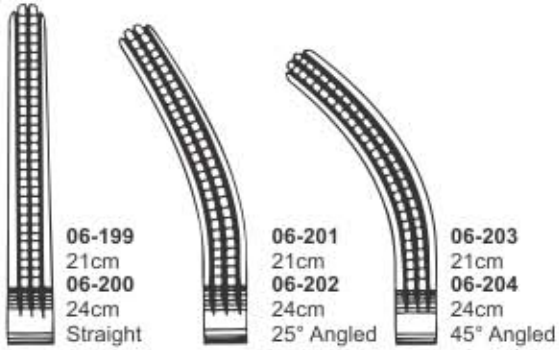

Bozemann Haemostatic Forceps

06-207
26cm
Curved
Serrated

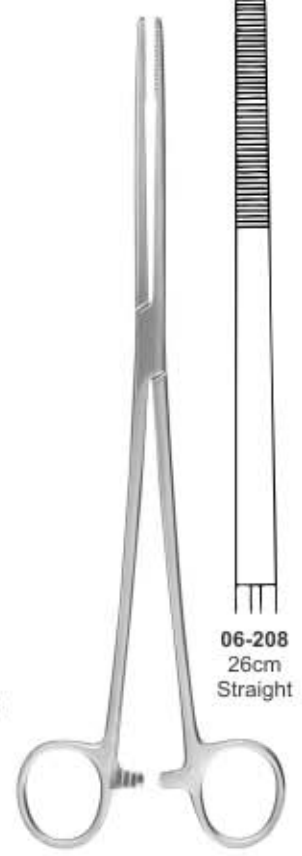

Bozemann Haemostatic Forceps

06-208
26cm
Straight



Westermark Haemostatic Forceps



Phaneuf Haemostatic Tissue Forceps

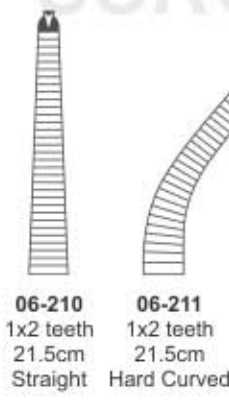

Long Haemostatic Tissue Forceps

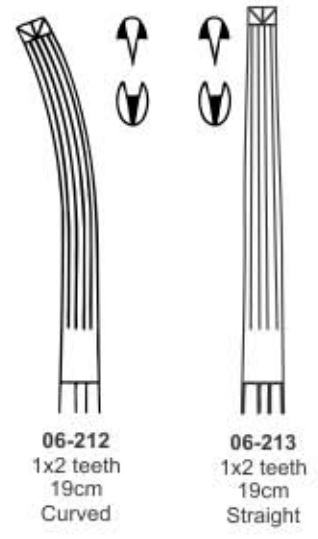

HAEMOSTATIC FORCEPS

Arterienklemmen
Pincas Hemostatiques

Pinzas Hemostaticas
Pinze Emostatiche



Baby-Mikulicz Haemostatic Tissue Forceps



Mikulicz Haemostatic Tissue Forceps



Mikulicz Haemostatic Tissue Forceps



Mikulicz Haemostatic Tissue Forceps



Mikulicz Haemostatic Tissue Forceps



Faure Haemostatic Tissue Forceps

HAEMOSTATIC FORCEPS

Arterienklemmen
Pincas Hemostatiquas

Pinzas Hemostaticas
Pinze Emostatiche



06-220
1x2 teeth
23.5cm

Wertheim Haemostatic
Tissue Forceps



06-221
1x2 teeth
24.5cm

Wertheim Haemostatic
Tissue Forceps



06-222
25.5cm

Wertheim Hysterectomy
Forceps

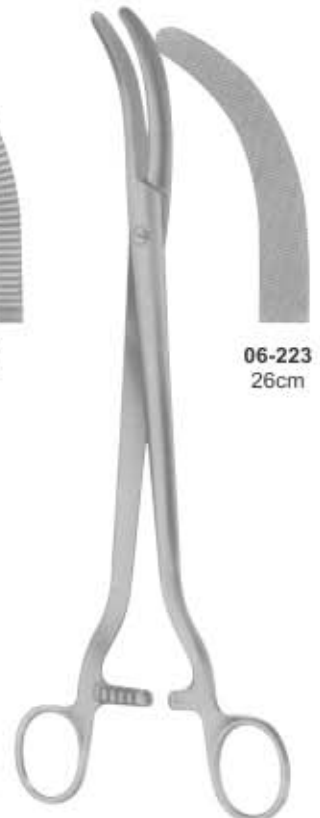

06-223
26cm

Wertheim Parametrium
Clamp



Heaney Atraumata
Hysterectomy Forceps

06-224
22.5cm
Straight



06-225
22.5cm
25° Angled

06-226
21.5cm
45° Angled



06-227
20.5cm
90° Angled



06-228
25cm
Straight

06-229
24.5cm
25° Angled

06-230
24cm
45° Angled



06-231
22cm
90° Angled

Wertheim Parametrium Clamps

HAEMOSTATIC FORCEPS

Arterienklemmen
Pincas Hemostatiques

Pinzas Hemostaticas
Pinze Emostatiche



Gemini Mixer Hemostatic Forceps
06-232 14cm
06-233 17.75cm
full curve, delicate



Dick Haemostatic Forceps



06-234 25.5cm
06-235 26.5cm
06-236 27.5cm

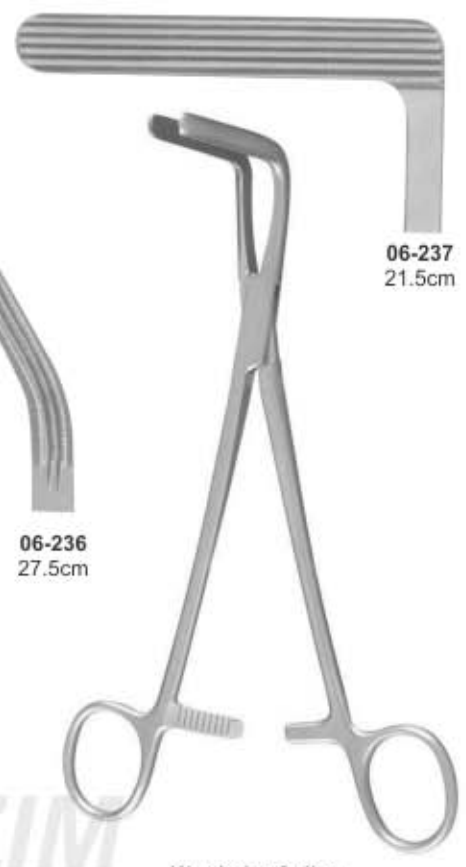

Wertheim-Cullen Haemostatic Forceps

06-237
21.5cm



Wertheim-Cullen Haemostatic Forceps
23cm



06-238 60mm
06-239 80mm



Wertheim Haemostatic Forceps

06-240
25cm

Tuchklemmen | Pincers à champs
 Pinzas de campo | Pinze fissatele



Jones / Perforating Towel Forceps 06-241 9 cm Slight Curve
Jones-Martin Towel Clamp sharp 06-242 8.5 cm
Engl. Modell Towel Forceps 06-243 9 cm
Schaedel Towel Forceps 06-244 9 cm
Thomson-Walker's Penile Clamps 06-245 9 cm Cross-Action model.
Doyen 06-246 11cm
Doyen Towel Forceps 06-247 18 cm
Fricke Artery Forceps 06-248 13cm

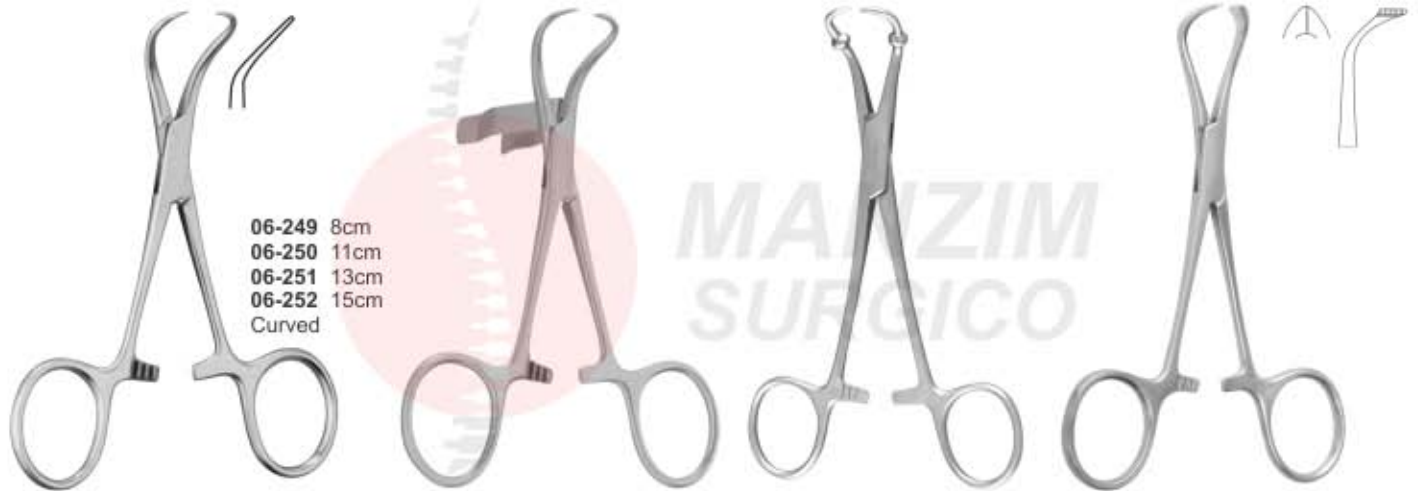

06-249 8cm
 06-250 11cm
 06-251 13cm
 06-252 15cm
 Curved

Backhaus Towel Forceps
Backhaus Clip Towel Forceps 06-253 11cm with clip for tubing or cable
Roeder Towel Forceps 06-254 13cm 06-255 15cm Curved, Serrated
Lorna Towel Forceps 06-256 9cm 06-257 11.4cm 06-258 13.5cm



Ball & Socket Towel Forceps 06-259 13cm Non-perforating
Tohoku Towel Forceps 06-260 10cm 06-261 13cm Non-Perforating
Non-Perforating Towel Forceps 06-262 11cm 06-263 13cm
Peers-Bertman Towel Forceps 06-264 14.5cm Serrated

HAEMOSTATIC FORCEPS

Arterienklemmen
Pincas Hemostatiques

Pinzas Hemostaticas
Pinze Emostatiche



Bernhard Towel Forceps
06-265 16.5cm

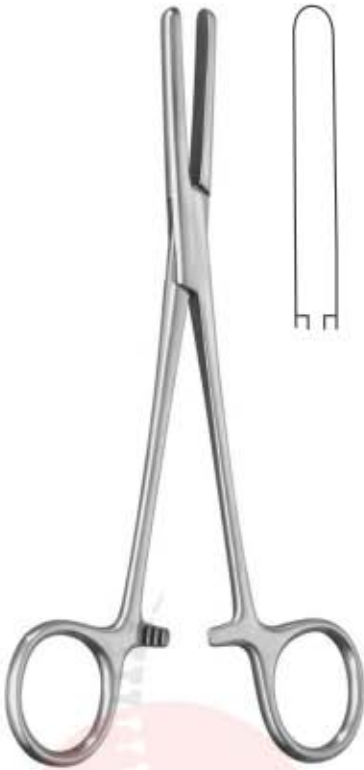

Presbyterian Tubing Clamp
06-266 16.5cm
06-267 18cm
Straight, Smooth



Tubing Clamp
06-268 18cm
06-269 20cm
Cross Serrated



Klinikum Berlin Tubing Clamp

06-270
14.5cm
with long
ratchet

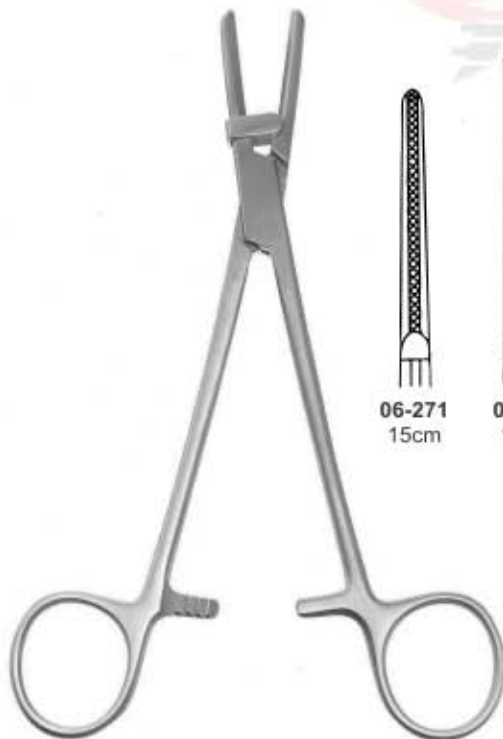

Tubing Clamp with Protector
Cross Serrated

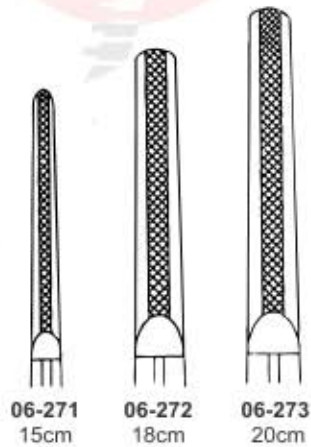

06-271 15cm
06-272 18cm
06-273 20cm

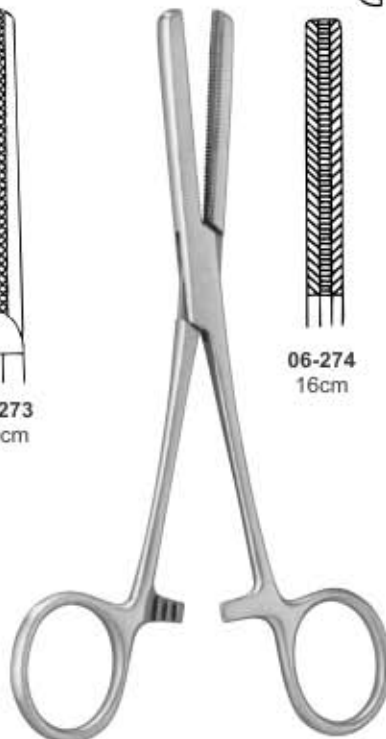

Fergusson Tubing Clamp

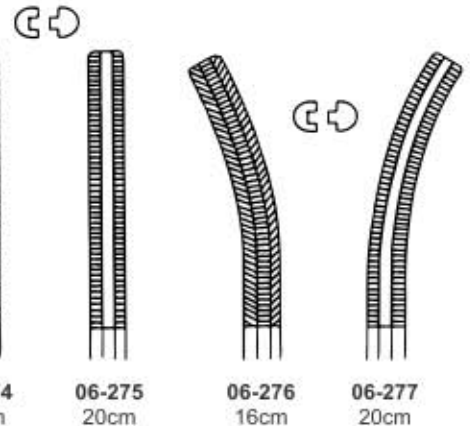

06-274 16cm
06-275 20cm
06-276 16cm
06-277 20cm

HAEMOSTATIC FORCEPS

Arterienklemmen
Pincas Hemostatiquas

Pinzas Hemostaticas
Pinze Emostatiche



Tuffier Haemostatic Forceps
06-278 13cm



Chaput Haemostatic Forceps
06-279 13cm



Pratt Haemostatic Forceps
06-280 15cm



Pennington / Siezing Haemostatic Forceps
06-281 15.5cm
06-282 20cm
Straight



Martel Haemostatic Forceps
06-283 14cm

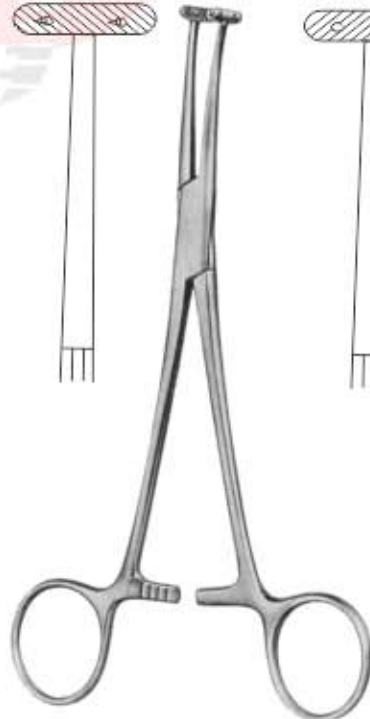

Willet-Martel Haemostatic Forceps
06-284 19cm

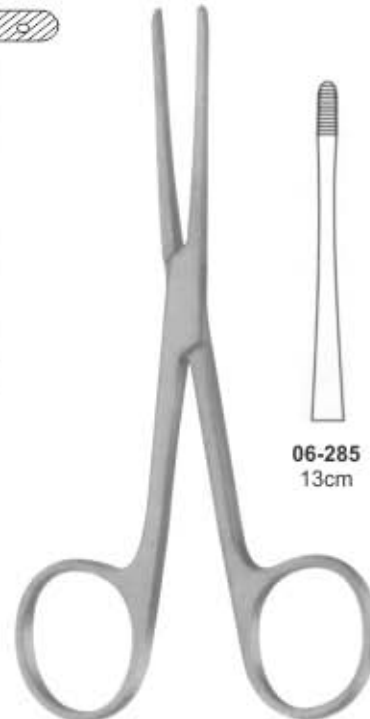

Lister Sinus Forceps



06-285
13cm

06-286
15.5cm

06-287
17.5cm

HAEMOSTATIC FORCEPS

Arterienklemmen
Pincas Hemostatiques

Pinzas Hemostaticas
Pinze Emostatiche



06-288
12.5cm

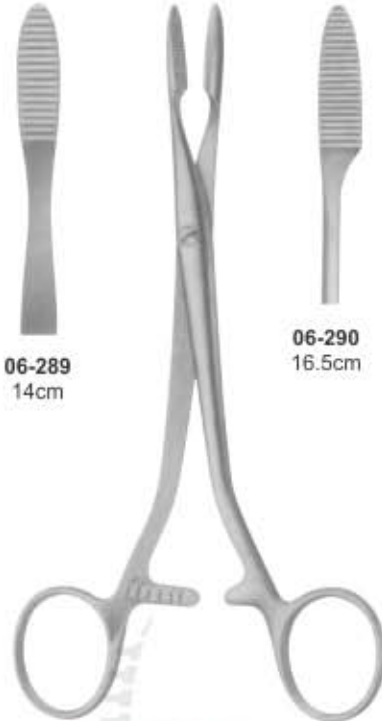

06-289
14cm



06-290
16.5cm



06-291
18.5cm

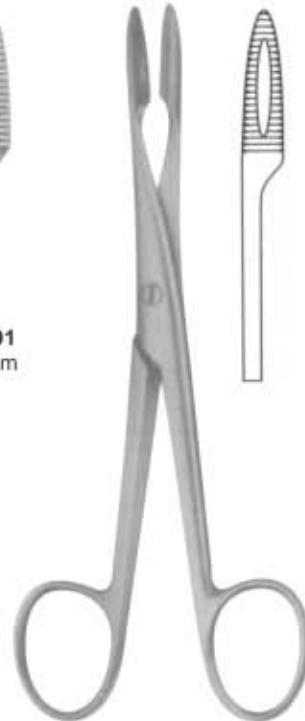

Gross Maier Dressing Forceps
06-292 14.5cm straight
Without Ratchet



Gross Maier Dressing Forceps
06-293 14.5cm straight
With Ratchet



Gross Maier Dressing Forceps
06-294 14.5cm, curved
With Ratchet



Gross Maier Dressing Forceps
06-295 14.5cm, curved
With Ratchet

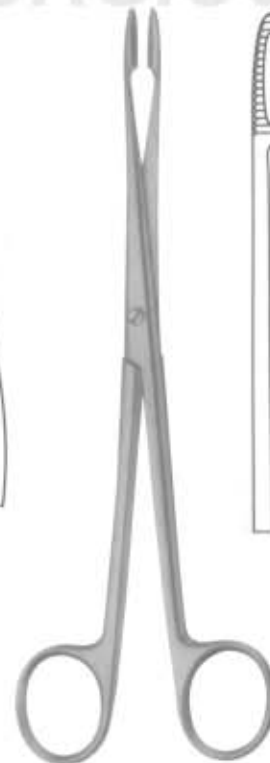

Gross Maier Dressing
Sponge & Dressing Forceps
06-296 20.5cm, straight
Without Ratchet



Gross Maier Dressing
Sponge & Dressing Forceps
06-297 17.8cm, straight
With Ratchet

MANZIM
SURGICO

Arterienklemmen
Pincas Hemostatiquas

Pinzas Hemostaticas
Pinze Emostatiche



**Gross Maier Dressing
Sponge & Dressing Forceps**
06-298 20.5cm, curved
Without Ratchet
(bullet holding forceps)

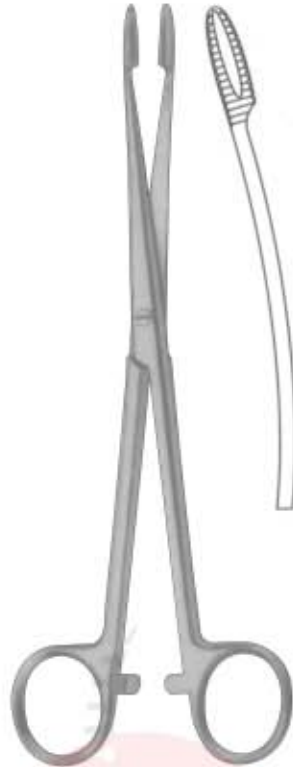

**Gross Maier Dressing
Sponge & Dressing Forceps**
06-299 17.8cm, curved
With Ratchet



Gross Maier Dressing Forceps
06-300 26.5cm, straight
Without Ratchet
(bullet holding forceps)



Gross Maier Dressing Forceps
06-301 26.5cm, straight
With Ratchet
(bullet holding forceps)



Gross Maier Dressing Forceps
06-302 26.5cm, curved
Without Ratchet
(bullet holding forceps)

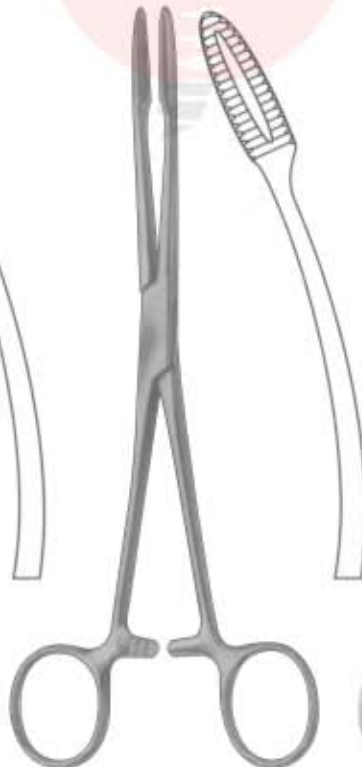

Gross Maier Dressing Forceps
06-303 26.5cm, curved
With Ratchet
(bullet holding forceps)

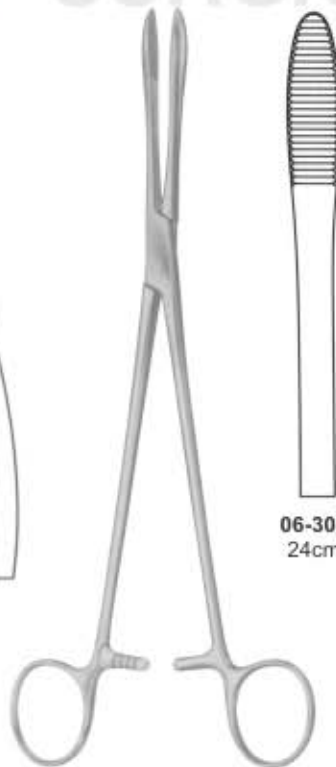

**Collin Sponge &
Dressing Forceps**

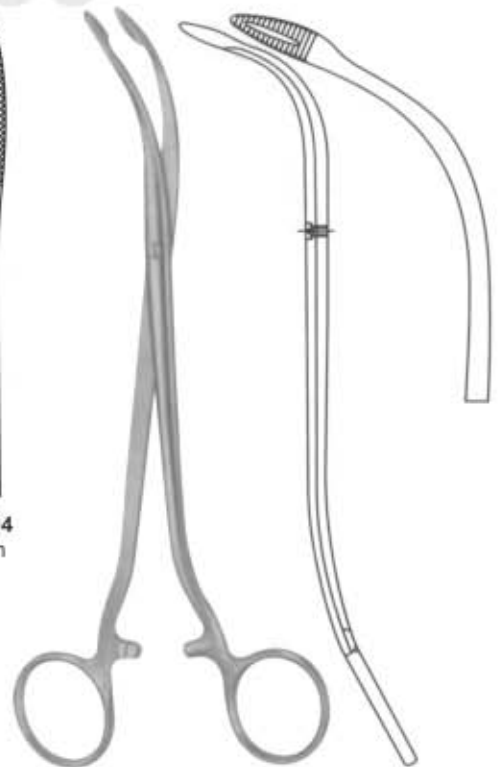

**Duplay Sponge &
Dressing Forceps**
06-305 19cm
Slight Curve

Arterienklemmen
Pincas Hemostatiques

Pinzas Hemostaticas
Pinze Emostatiche



06-306
28cm
Straight

Sims-Maier Sponge & Dressing Forceps



06-307
28cm
Curved

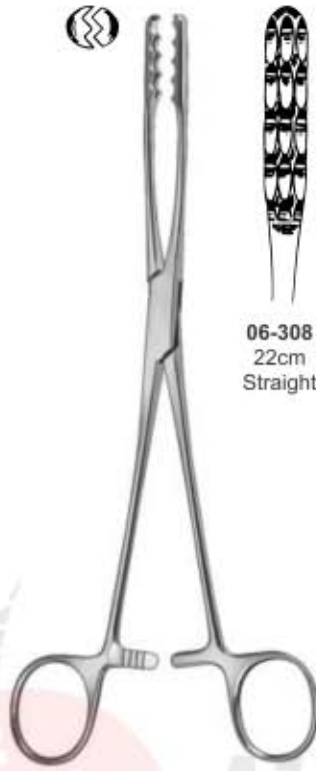

06-308
22cm
Straight

Ulrich Sponge Forceps

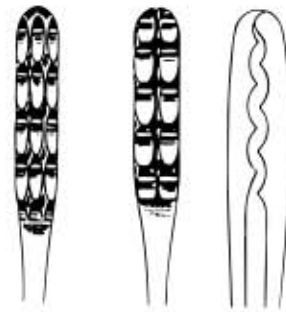

06-309
25cm
06-310
27cm
Straight

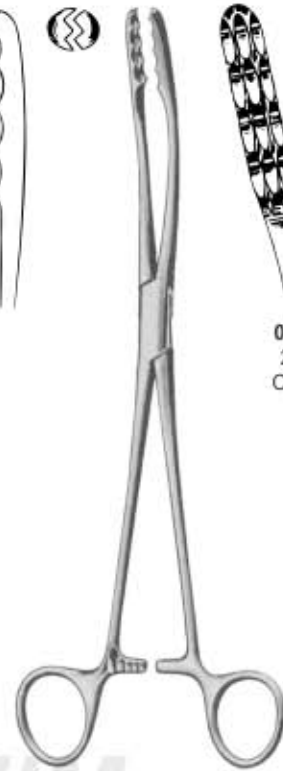

06-311
22cm
Curved

Ulrich Sponge Forceps



06-312
25cm
06-313
27cm
Curved



06-314
22cm
Straight

Aesculap Sponge & Dressing Forceps



06-315
22cm
Curved



06-316
24cm
Straight

Fletcher Sponge Forceps



06-317
24cm
Slight Curve

Fletcher Sponge Forceps



06-318
25cm
Straight

Pelkmann Sponge Forceps

HAEMOSTATIC FORCEPS

Arterienklemmen

Pinzas Hemostaticas

Pinces Hemostatiques

Pinze Emostatiche

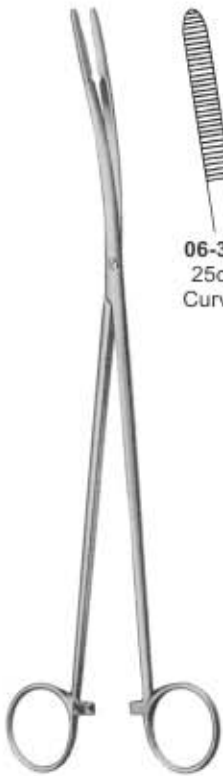

06-319
25cm
Curved

Pelkmann Sponge Forceps



06-320
24cm

Cheron Forceps
Handles Laterally Angled



06-321
20.5cm
Straight

Duplay Sponge Forceps



06-322
20.5cm
Curved

Duplay Sponge Forceps



Heywood Smith Sponge Forceps
06-323 25cm

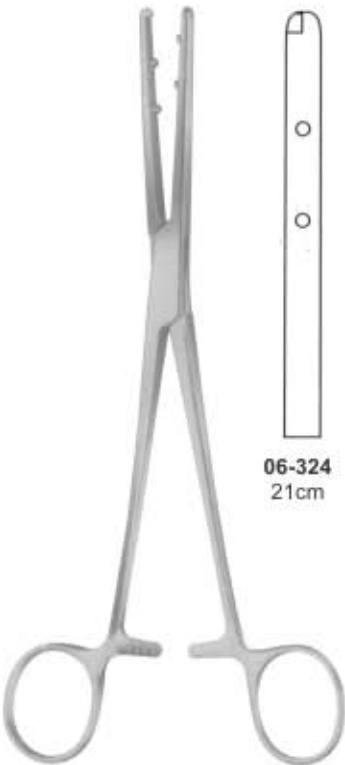

06-324
21cm

Emmet Sponge & Dressing Forceps



Tendon Seizing Forceps



06-325
15.5cm

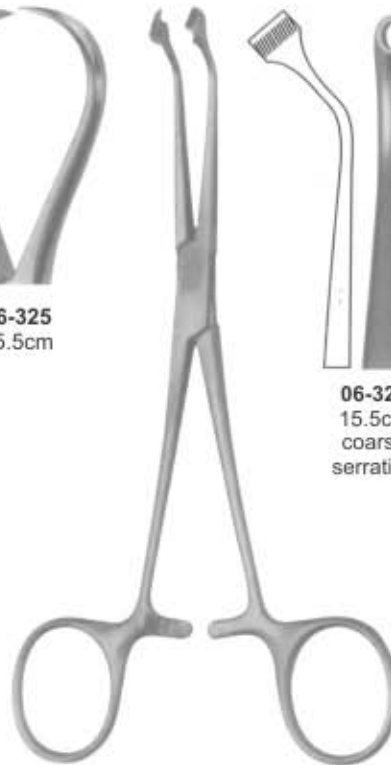

Herz Tendon Seizing Forceps



06-326
15.5cm
coarse
serration

06-327
15.5cm
fine
serrations

HAEMOSTATIC FORCEPS

Arterienklemmen
Pinces Hemostatiques

Pinzas Hemostaticas
Pinze Emostatiche



Noto Sponge & Dressing Forceps
06-328 28cm

Kelly Sponge & Dressing Forceps

06-329
32cm
Curved

06-330
32cm
Straight

Heywood-Smith Sponge & Dressing Forceps
06-331 20cm

Collin Sponge & Dressing Forceps

06-332
16cm
06-333
17cm

06-334
16cm

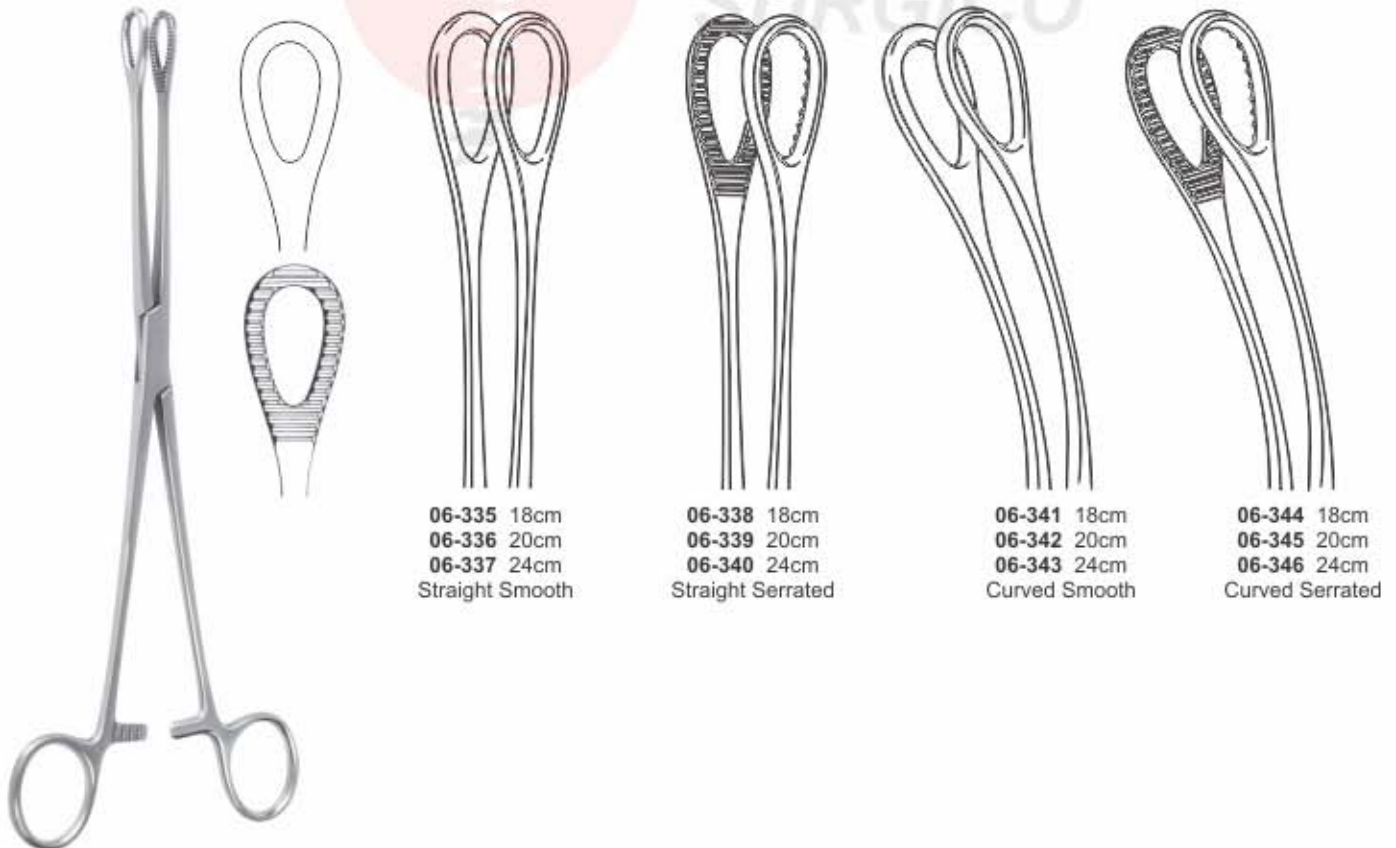

06-335 18cm
06-336 20cm
06-337 24cm
Straight Smooth

06-338 18cm
06-339 20cm
06-340 24cm
Straight Serrated

06-341 18cm
06-342 20cm
06-343 24cm
Curved Smooth

06-344 18cm
06-345 20cm
06-346 24cm
Curved Serrated

Foerster-Ballenger Sponge Forceps
& (bullet holding forceps)

NEEDLE HOLDERS







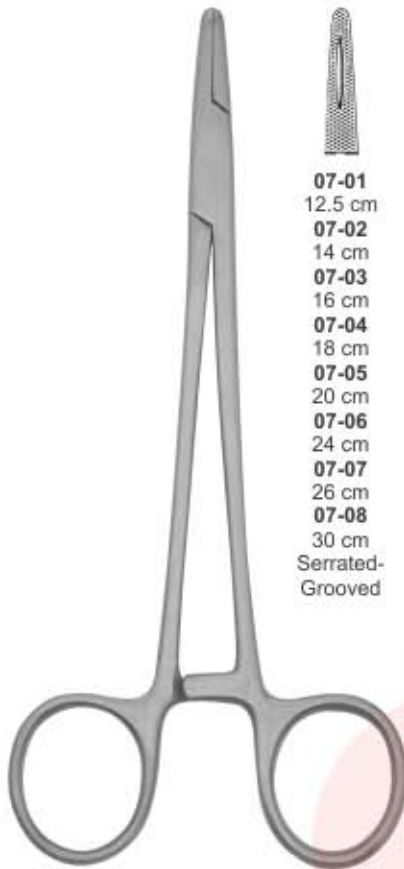

NEEDLE HOLDERS

Nadelhalter
Prote-aiguilles

Porta-agujas
Porta aghi



**Mayo-Hegar
Needle Holders**

					
07-01 12.5 cm	07-09 12.5 cm	07-17 16 cm	07-20 12.5 cm	07-28 12.5 cm	07-36 12.5 cm
07-02 14 cm	07-10 14 cm	07-18 18 cm	07-21 14 cm	07-29 14 cm	07-37 14 cm
07-03 16 cm	07-11 16 cm	07-19 20 cm	07-22 16 cm	07-30 16 cm	07-38 16 cm
07-04 18 cm	07-12 18 cm	Serrated- Grooved left handed	07-23 18 cm	07-31 18 cm	07-39 18 cm
07-05 20 cm	07-13 20 cm		07-24 20 cm	07-32 20 cm	07-40 20 cm
07-06 24 cm	07-14 24 cm	07-25 24 cm	07-26 26 cm	07-33 24 cm	07-41 24 cm
07-07 26 cm	07-15 26 cm	07-27 30 cm	07-28 26 cm	07-34 26 cm	07-42 26 cm
07-08 30 cm	07-16 30 cm	Serrated- Grooved Curved	07-29 30 cm	07-35 30 cm	07-43 30 cm
Serrated- Grooved	Serrated		Serrated Curved		Serrated-Solid

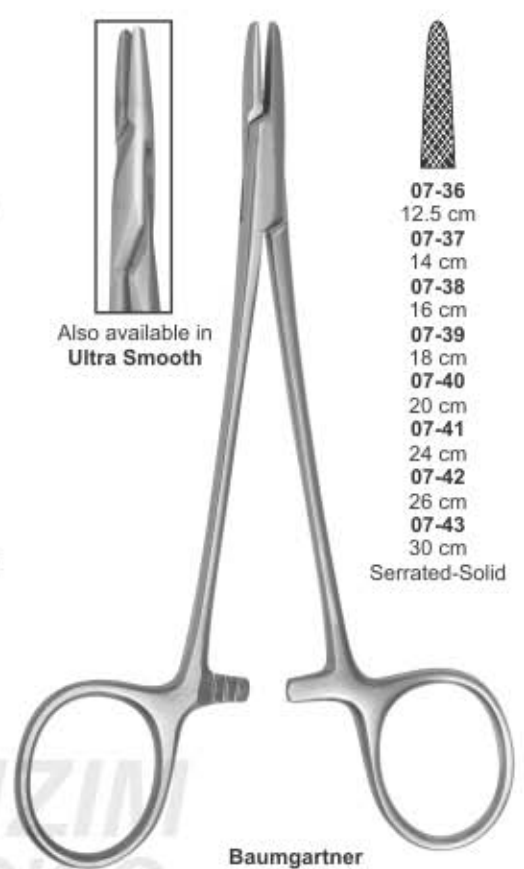

**Baumgartner
Needle Holder**

Also available in
Ultra Smooth

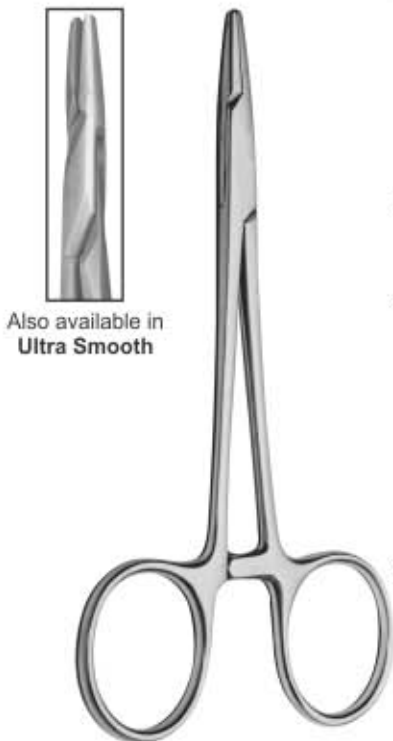

**Webster
Needle Holder**

Also available in
Ultra Smooth

07-44 11.5 cm
07-45 12 cm
07-46 12.5 cm
07-47 13 cm
07-48 14 cm
07-49 15 cm
07-50 18 cm
07-51 20 cm
Smooth



**Brown
Needle Holder**

Also available in
Ultra Smooth

07-52 13 cm
07-53 18 cm
Serrated-Solid



**Baby Crile-Wood
Needle Holder**

Also available in
Ultra Smooth



07-54 15 cm

NEEDLE HOLDERS

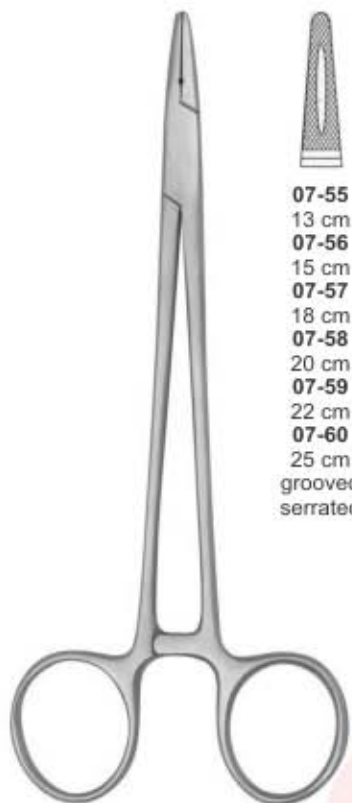
Nadelhalter | Porta-agujas
 Prote-aiguilles | Porta aghi



**Crile-Wood
Needle Holder**

- | | |
|---|---|
|  |  |
| 07-55
13 cm | 07-61
13 cm |
| 07-56
15 cm | 07-62
15 cm |
| 07-57
18 cm | 07-63
18 cm |
| 07-58
20 cm | 07-64
20 cm |
| 07-59
22 cm | 07-65
22 cm |
| 07-60
25 cm
grooved
serrated | 07-66
25 cm
solid
serrated |

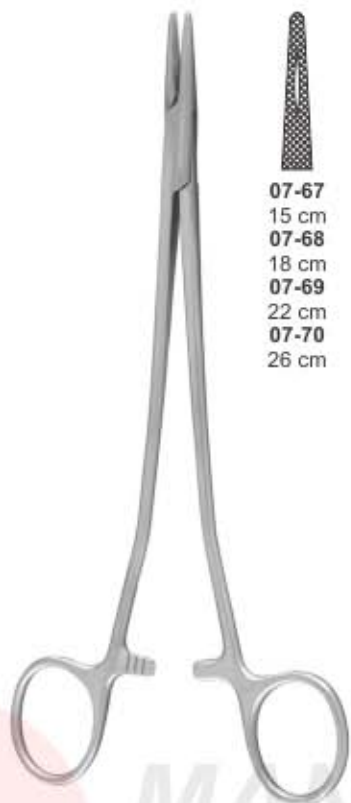

Sarot Needle Holders

- | |
|---|
|  |
| 07-67
15 cm |
| 07-68
18 cm |
| 07-69
22 cm |
| 07-70
26 cm |

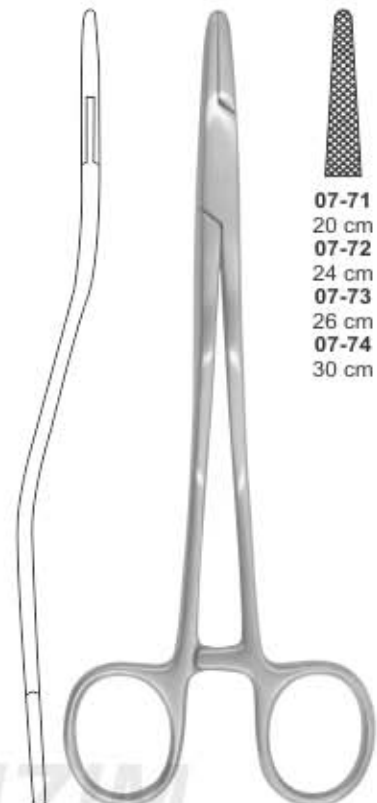

Bozemann Needle Holders

- | |
|---|
|  |
| 07-71
20 cm |
| 07-72
24 cm |
| 07-73
26 cm |
| 07-74
30 cm |



Also available in
Ultra Smooth

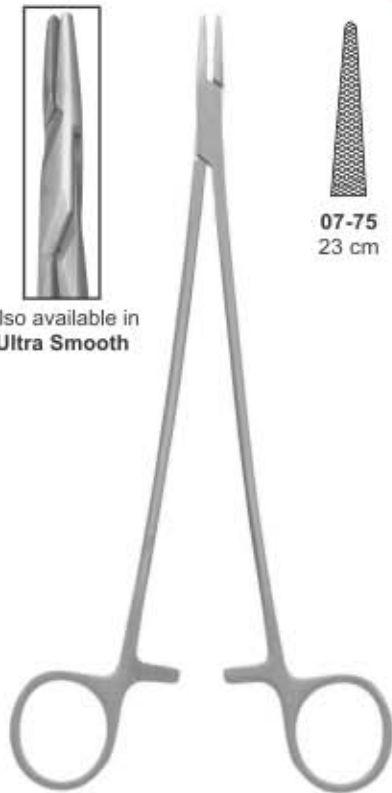

Jameson Needle Holders

- | |
|---|
|  |
| 07-75
23 cm |



Finocchietto Needle Holders

- | |
|---|
|  |
| 07-76
27 cm |



Also available in
Ultra Smooth

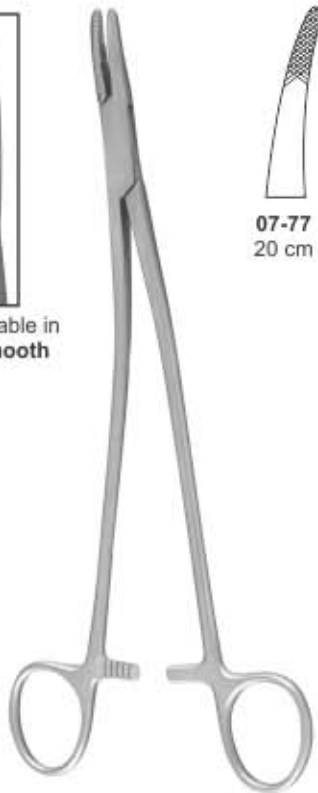

Stratte Needle Holders

- | |
|---|
|  |
| 07-77
20 cm |

- | |
|---|
|  |
| 07-78
23 cm |

NEEDLE HOLDERS

Nadelhalter	Porta-agujas
Prote-aiguilles	Porta aghi

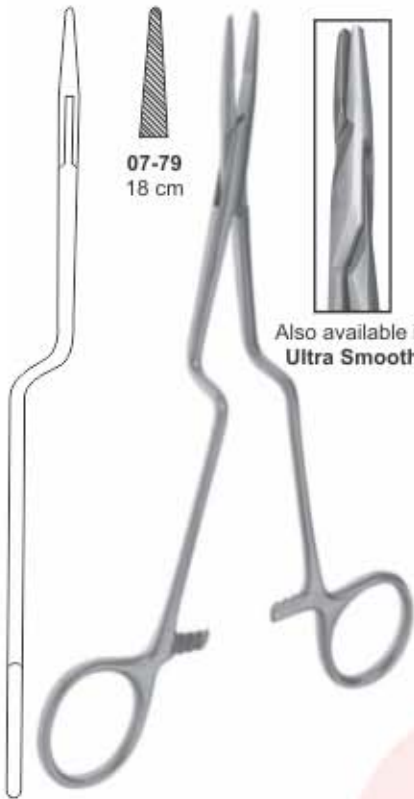

07-79
18 cm



Also available in
Ultra Smooth



Also available in
Ultra Smooth

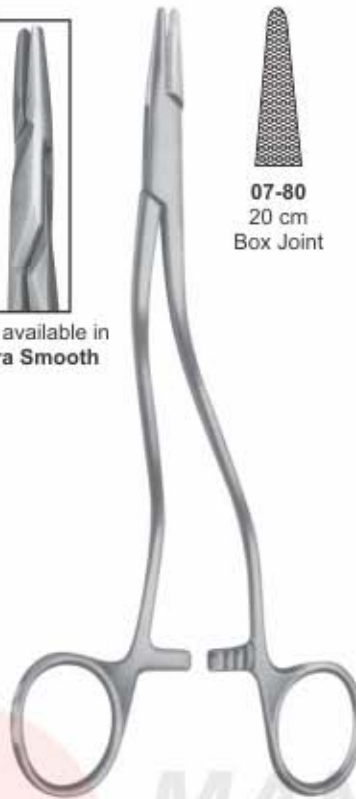

07-80
20 cm
Box Joint



07-81 18 cm
07-82 25 cm
Pound Action Joint.

Jacobson Needle Holders

Thomson Walker Needle Holders

Naunton Morgan Needle Holders



07-83
17 cm



07-84
18 cm



07-85
18 cm

Mass. General Hospital Needle Holders

Adson Needle Holders

New Orleans Needle Holders

NEEDLE HOLDERS

Nadelhalter | Porta-agujas
 Prote-aiguilles | Porta aghi



07-86
20 cm
Cvd.

07-87
27 cm
Cvd.

Heaney Needle Holders

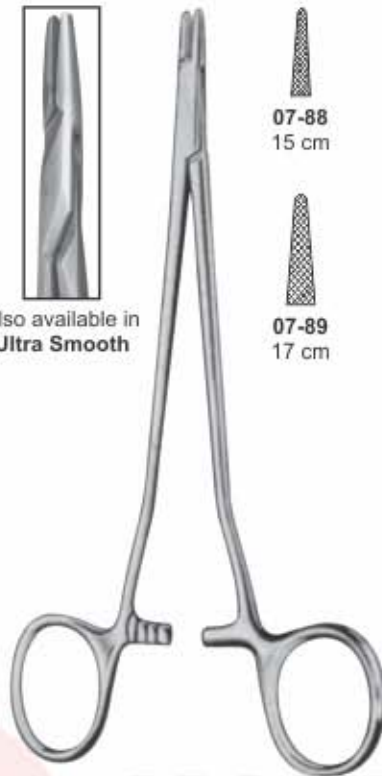

07-88
15 cm

07-89
17 cm

Also available in
Ultra Smooth

**Senning Needle Holders
(Schwed. Model)**

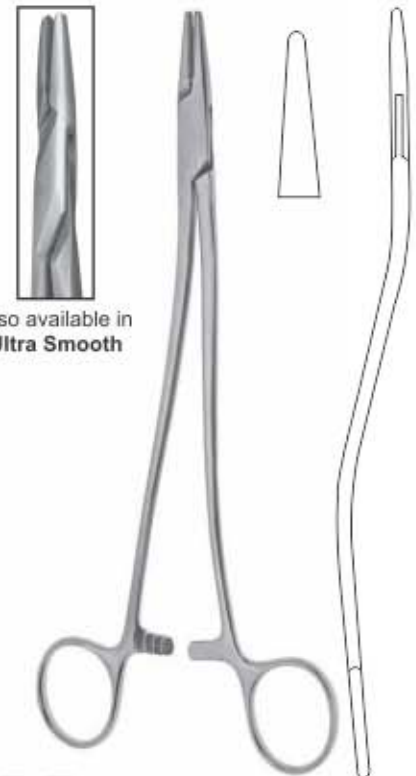

Also available in
Ultra Smooth

Wertheim Needle Holders

07-90 20 cm
07-91 24 cm

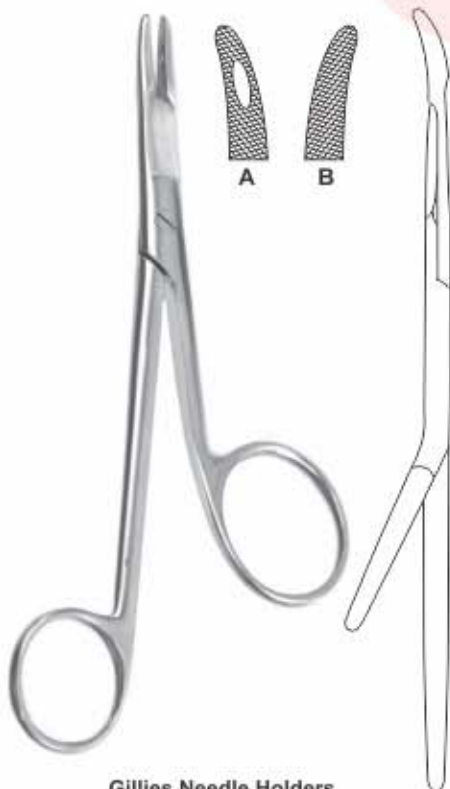

A

B

Gillies Needle Holders
07-92 16 cm



07-93
27 cm
Serrated

**Masson-Luethy
Needle Holders**



07-94 11.5 cm
07-95 14 cm
07-96 17 cm
07-97 19 cm
serrated

07-98 11.5 cm
07-99 14 cm
07-100 17 cm
07-101 19 cm
smooth

Olsen-Hegar Needle Holders

NEEDLE HOLDERS

Nadelhalter	Porta-agujas
Prote-aiguilles	Porta aghi



07-102
13 cm
serrated

07-103
13 cm
smooth

Halsey Needle Holders

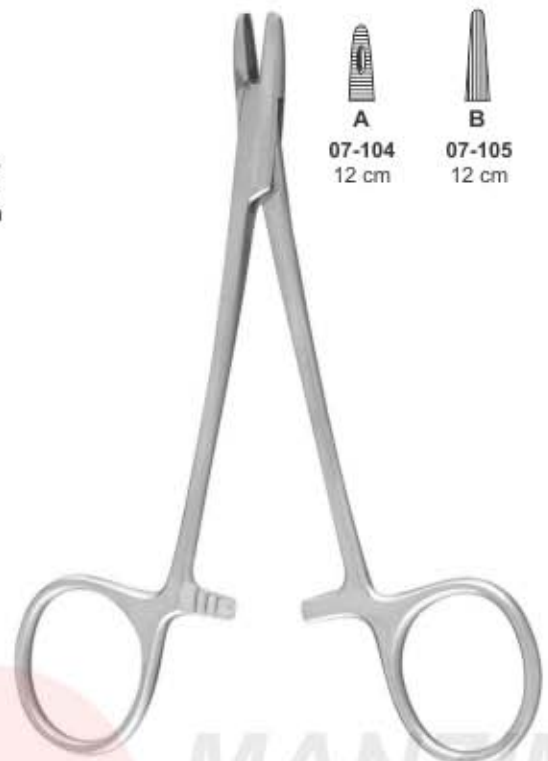

A
07-104
12 cm

B
07-105
12 cm

B
07-106
12 cm

Derf Needle Holders

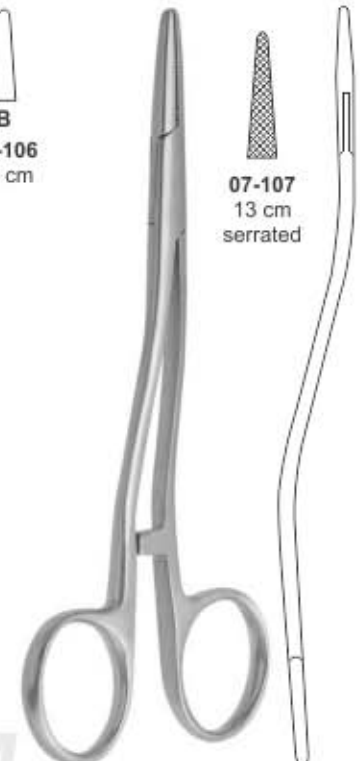

07-107
13 cm
serrated

Kilner Needle Holders

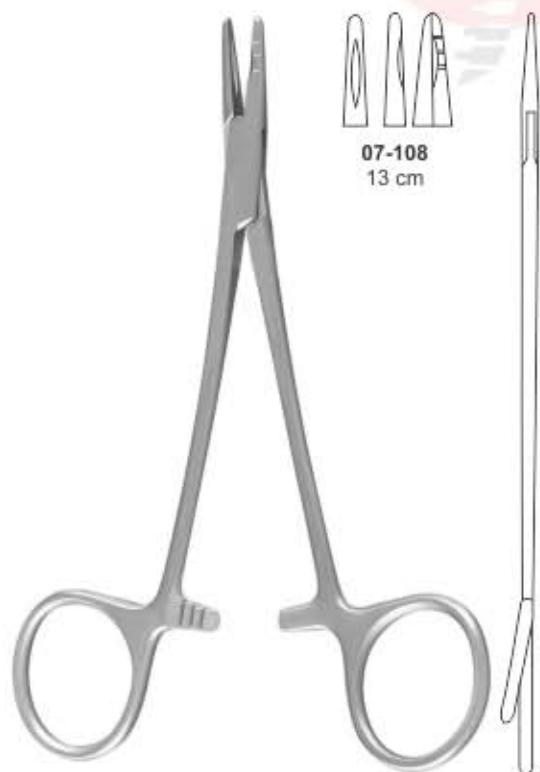

07-108
13 cm

Neivert Needle Holders



07-109
12.5 cm

Collier Needle Holders



07-110
12.5 cm

Doyen Needle Holders

NEEDLE HOLDERS

Nadelhalter | Porta-agujas
 Prote-aiguilles | Porta aghi



07-111
 15 cm
 Slender
 pattern

**Crile-Murray
 Needle Holders**



07-112
 18.5 cm
 One grooved and
 fenestrated jaw

**Metzenbaum
 Needle Holders**



07-113
 27 cm
 Serrated-Solid

**Wangensteen
 Needle Holders**



07-114
 27 cm

Masson Needle Holder



Johnson Needle Holders

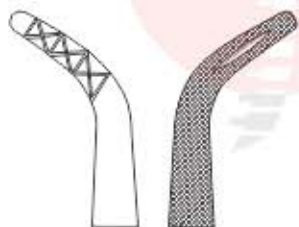

07-115
 27 cm



De Bakey Needle Holders

- 07-116** 18 cm
- 07-117** 20 cm
- 07-118** 22 cm
- 07-119** 25 cm



Intracardiac Needle Holders

- 07-120** 18 cm
- 07-121** 20 cm
- 07-122** 22 cm
- 07-123** 25 cm



Microvascular Needle Holders

- 07-124** 18 cm
- 07-125** 20 cm
- 07-126** 22 cm
- 07-127** 25 cm

NEEDLE HOLDERS

Nadelhalter | Porta-agujas
Prote-aiguilles | Porta aghi

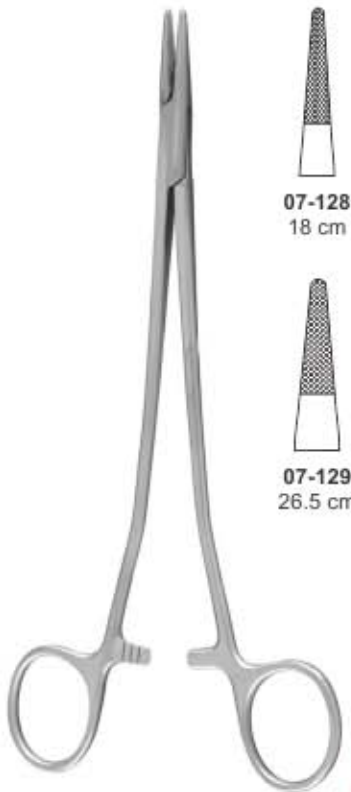

07-128
18 cm

07-129
26.5 cm

Sarot Needle Holders



07-130
15 cm
07-131
18 cm
07-132
20 cm

Micro Ryder Needle Holders

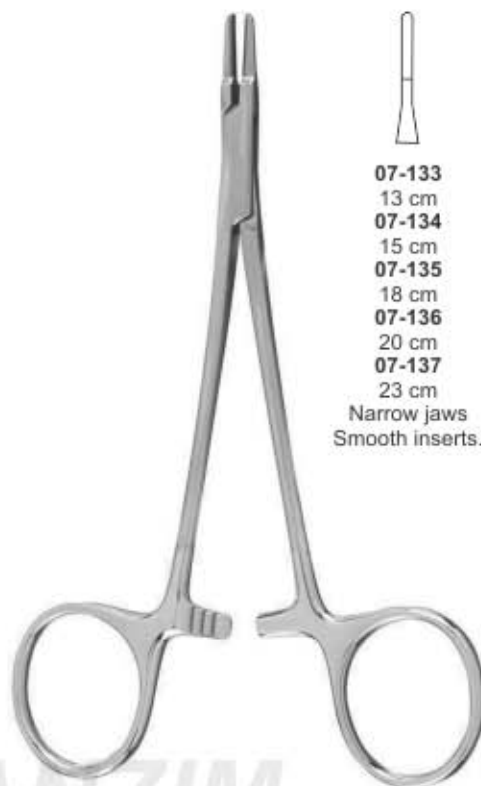

07-133
13 cm
07-134
15 cm
07-135
18 cm
07-136
20 cm
07-137
23 cm
Narrow jaws
Smooth inserts.

07-138
13 cm
07-139
15 cm
07-140
18 cm
07-141
20 cm
07-142
23 cm
Narrow jaws
serrated

Ryder Needle Holders
Narrow jaws.



French-Eye Needle Holder
07-143 16 cm
07-144 18 cm
07-145 20 cm
07-146 22 cm
07-147 25 cm
Narrow Tip



French-Eye Needle Holder
07-148 16 cm
07-149 18 cm
07-150 20 cm
07-151 22 cm



07-152
18 cm
07-153
20 cm
07-154
23 cm
07-155
26 cm

Cooley Intracardiac Needle Holders
Straight, narrow jaw.

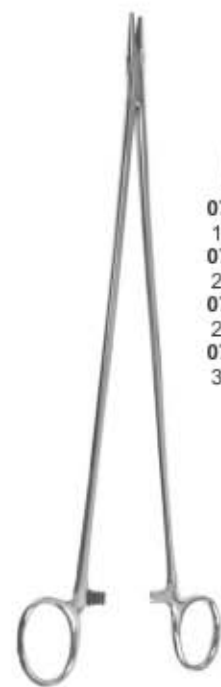

07-156
18 cm
07-157
23 cm
07-158
27 cm
07-159
30 cm

Debakey Cardiovascular Needle Holders
Delicate patterns.
Straight jaw, serrated.

NEEDLE HOLDERS

Nadelhalter | Porta-agujas
 Prote-aiguilles | Porta aghi



Finochietto Needle Holders
 07-160 13 cm
 07-161 16 cm
 07-162 19 cm
 07-163 21 cm



Finochietto Needle Holders
 07-164 13 cm Angled
 07-165 16 cm Angled
 07-166 19 cm Angled

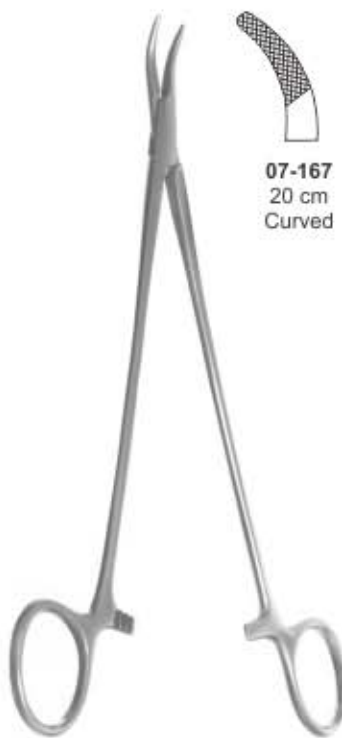

07-167
 20 cm
 Curved



07-168
 14 cm
07-169
 17 cm
07-170
 20 cm



07-171
 14 cm
07-172
 16.5 cm
07-173
 20 cm
 Narrow Jaws



07-174
 18 cm
07-175
 23 cm

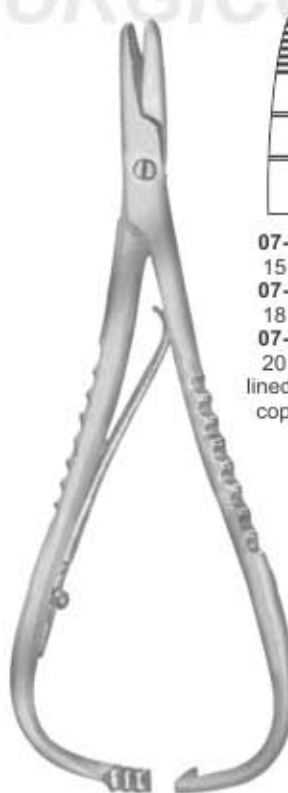

07-176
 15 cm
07-177
 18 cm
07-178
 20 cm
 lined with copper.



07-179
 15 cm

Mathieu Needle Holders

Mayo Rochester Needle Holders
 button release, screw joint.

Macphail Needle Holders

Crile Needle Holders

NEEDLE HOLDERS

Nadelhalter
Prote-aiguilles

Porta-agujas
Porta aghi



07-180
18.5 cm

Toennis Needle Holders



07-181
13 cm
with lock
straight



07-182
13 cm
with lock
curved



07-183
13 cm
without lock
straight



07-184
13 cm
without lock
curved

Castroviejo Needle Holders



07-185
10 cm
07-186
14 cm
Straight, Smooth
with lock Straight



07-187
10 cm
07-188
14 cm
Curved, Smooth
with lock curved

**Troutman
Needle Holders**

MANZIM
SURGICO



**Barraquer Micro
Needle Holders**
07-189 11cm
07-190 13cm



**Barraquer
Needle Holders**



07-191
13 cm
Straight, Smooth
without lock
Straight



07-192
13 cm
Curved, Smooth
without lock
curved



**Castroviejo
Needle Holders**



07-193
14 cm
Straight
Smooth
with lock



07-194
14 cm
Straight
Smooth
without lock



07-195
14 cm
Curved
Smooth
with lock



07-196
14 cm
Curved
Smooth
without lock



07-197
18 cm
Straight
Smooth
with lock



07-198
18 cm
Straight
Smooth
without lock



07-199
18 cm
Curved
Smooth
with lock



07-200
18 cm
Curved
Smooth
without lock

NEEDLE HOLDERS

Nadelhalter | Porta-agujas
 Prote-aiguilles | Porta aghi



07-201
13 cm
07-202
15 cm

Castroviejo Olsen Hegar /
Needle Holders / Scissors



07-203
12 cm

Boynton Needle Holders



07-204
16 cm
Str.



07-205
16 cm
Cvd.

Arruga Needle Holders



07-206
19 cm
07-207
23 cm
Smooth
Str.



07-208
19 cm
07-209
23 cm
Smooth
Cvd.

Micro Needle Holders

MANZIM
SURGICO



07-210
16 cm
Smooth
Cvd.

Micro Needle
Holders



Castroviejo Needle
Holders

07-211
12 cm
Smooth Str
with lock

07-212
12 cm
Smooth Cvd
with lock



Barraquer-Trountman
Needle Holders

07-213
10 cm
07-214
11.5 cm
Smooth
Str.

07-215
10 cm
07-216
11.5 cm
Smooth
Cvd.



Kalt Needle Holders

07-217
14 cm
Serrated



Arruga Needle Holders

07-218
14 cm
Serrated
Str.

07-219
14 cm
Serrated
Cvd.



Nadelhalter | Porta-agujas
Prote-aiguilles | Porta aghi



- 07-220 14 cm
- 07-221 18 cm
- 07-222 20 cm
- 07-223 23 cm
- 07-224 25 cm

Microvascular
Needle Holders T.C.

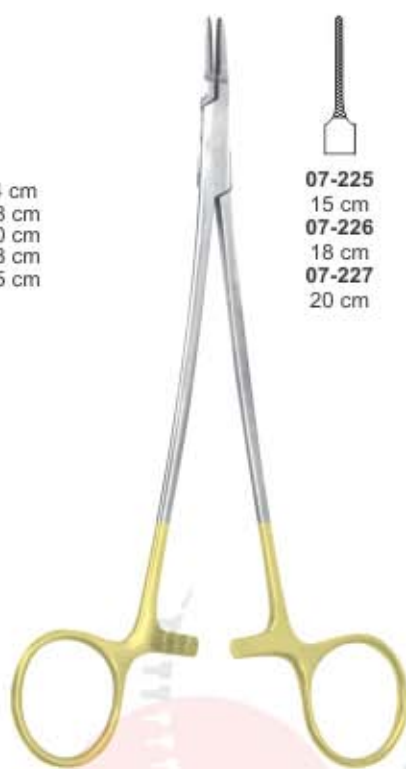

- 07-225 15 cm
- 07-226 18 cm
- 07-227 20 cm

Micro Ryder Needle
Holders T.C.



- 07-228 13 cm
- 07-229 15 cm
- 07-230 18 cm
- 07-231 20 cm
- 07-232 22 cm
- 07-233 25 cm

Crile-Wood Needle
Holders T.C.



- 07-234 18 cm
- 07-235 20 cm
- 07-236 22 cm
- 07-237 25 cm

Intracardiac Needle Holders T.C.



- 07-238 18 cm

New Orleans Needle
Holders T.C.



- 07-239 18 cm
Serrated-Solid



- 07-240 15 cm
- 07-241 17 cm

Senning Needle Holders T.C
(Schwed. Model)



- 07-242 15 cm
Serrated-Solid

Carroll Needle Holders T.C.

Nadelhalter | Porta-agujas
 Prote-aiguilles | Porta aghi

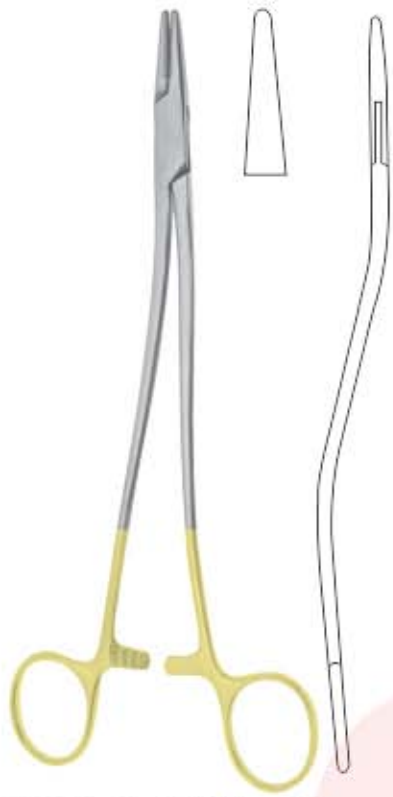

Wertheim Needle Holders T.C
 07-243 20 cm
 07-244 24 cm



Kilner Needle Holders T.C

07-245
 13 cm



Jacobson Needle Holders T.C

07-246
 18 cm

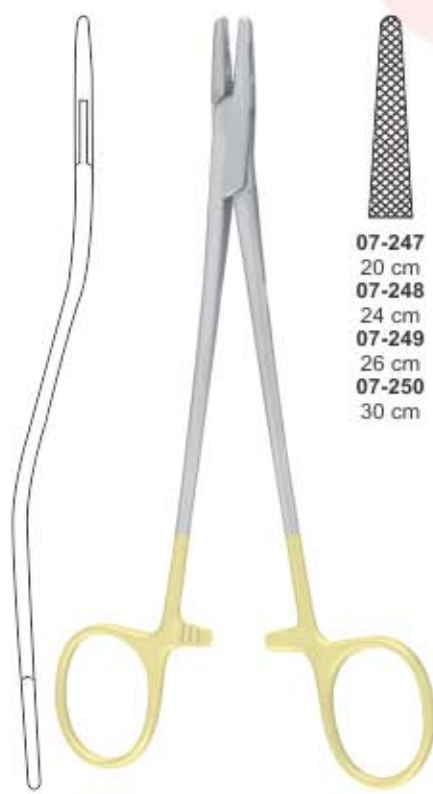

Bozemann Needle Holders T.C

07-247
 20 cm
 07-248
 24 cm
 07-249
 26 cm
 07-250
 30 cm



Baumgartner Needle Holders T.C

07-251
 13 cm
 07-252
 15 cm



Olsen-Hegar Needle Holders T.C

07-253 14 cm	07-256 14 cm
07-254 17 cm	07-257 17 cm
07-255 19 cm Serrated-Solid	07-258 19 cm Serrated-Solid

NEEDLE HOLDERS T.C.

Nadelhalter
Prote-aiguilles

Porta-agujas
Porta aghi



- 07-259 16 cm
- 07-260 18 cm
- 07-261 20 cm
- 07-262 22 cm
- 07-263 25 cm

- 07-264 16 cm
- 07-265 18 cm
- 07-266 20 cm
- 07-267 25 cm

- 07-268 18 cm
- 07-269 20 cm
- 07-270 26 cm
- Serrated-Solid

- 07-271 27 cm
- serrated

- 07-272 27 cm
- Tungsten Carbide

French-Eye Needle Holders T.C

French-Eye Needle Holders T.C

Sarot Needle Holders T.C

Wangensteen Needle Holders T.C



- 07-273 13 cm
- 07-274 16 cm
- 07-275 19 cm
- 07-276 21 cm

- 07-277 13 cm
- 07-278 16 cm
- 07-279 19 cm

- | | | |
|--------------|--------------|---------------|
| 07-280 15 cm | 07-287 15 cm | 07-294 16 cm |
| 07-281 18 cm | 07-288 18 cm | Right handed. |
| 07-282 20 cm | 07-289 20 cm | 07-295 20 cm |
| 07-283 23 cm | 07-290 23 cm | Right handed. |
| 07-284 25 cm | 07-291 25 cm | 07-296 16 cm |
| 07-285 28 cm | 07-292 28 cm | Left handed. |
| 07-286 30 cm | 07-293 30 cm | 07-297 20 cm |
| | | Left handed. |

Finochietto Needle Holders T.C

Finochietto Needle Holders T.C

Mayo-Hegar Needle Holders T.C
Also Available Right Handle

Nadelhalter | Porta-agujas
 Prote-aiguilles | Porta aghi



07-298
 20 cm
 Curved

Finochietto Needle Holders T.C



07-299
 18 cm

Rochester Needle Holders T.C

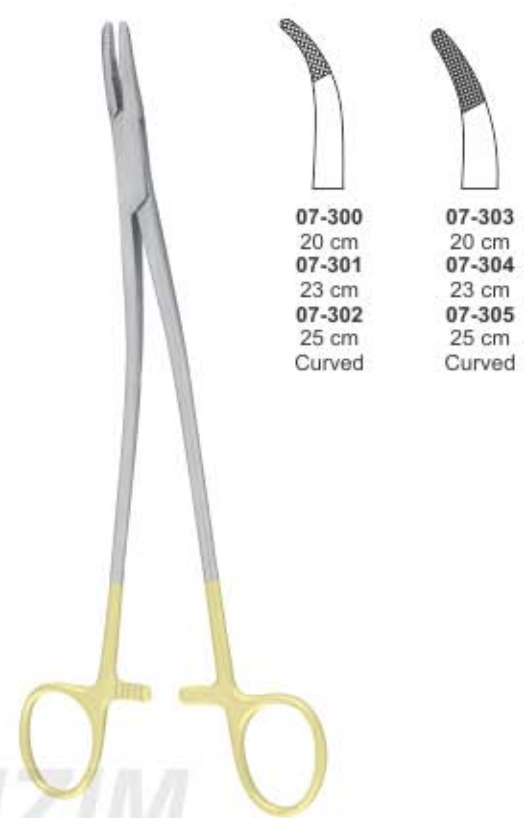

07-300
 20 cm
07-301
 23 cm
07-302
 25 cm
 Curved

07-303
 20 cm
07-304
 23 cm
07-305
 25 cm
 Curved

Stratte Needle Holders T.C



07-306
 16 cm

Gillies Needle Holders T.C



07-307
 12.5 cm
 Smooth

07-308
 12.5 cm
 Serrated-Solid

07-309
 12.5 cm
 Tungsten Carbide
 Smooth

07-310
 12.5 cm
 Tungsten Carbide
 Serrated-Solid

Halsey Needle Holders T.C



07-311
 14 cm
 Serrated-Delicate

**Eufrate Pasque T.C
 Needle Holders**

Nadelhalter
Prote-aguilles

Porta-agujas
Porta aghi



- | | |
|---------|---------|
| 07-312 | 07-317 |
| 12.5 cm | 12.5 cm |
| 07-313 | 07-318 |
| 15 cm | 15 cm |
| 07-314 | 07-319 |
| 18 cm | 18 cm |
| 07-315 | 07-320 |
| 20 cm | 20 cm |
| 07-316 | 07-321 |
| 23 cm | 23 cm |
- Smooth inserts.

Ryder Needle Holders T.C
Narrow jaws.



- | |
|--------|
| 07-322 |
| 18 cm |
| 07-323 |
| 20 cm |
| 07-324 |
| 23 cm |
| 07-325 |
| 26 cm |

Cooley Intracardiac Needle Holders T.C
Narrow Jaw.

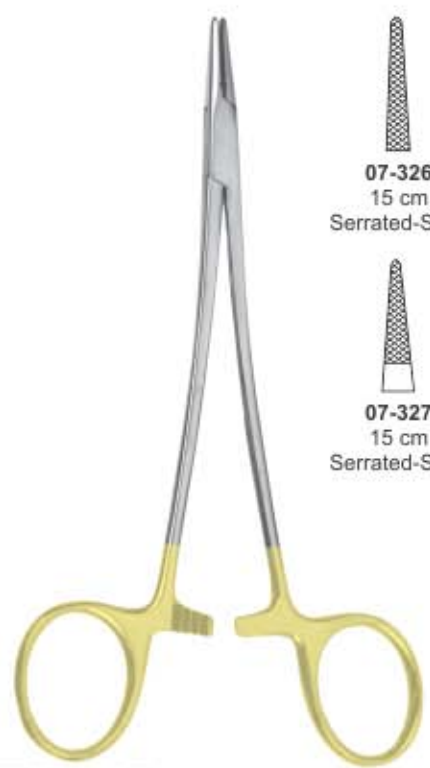

- | |
|----------------|
| 07-326 |
| 15 cm |
| Serrated-Solid |
| 07-327 |
| 15 cm |
| Serrated-Solid |

Baby Crile-Wood Needle Holders T.C



- | | |
|--------|----------------|
| 07-328 | 07-334 |
| 13 cm | 13 cm |
| 07-329 | 07-335 |
| 15 cm | 16 cm |
| 07-330 | 07-336 |
| 18 cm | 18 cm |
| 07-331 | 07-337 |
| 20 cm | 20 cm |
| 07-332 | 07-338 |
| 23 cm | 23 cm |
| 07-333 | Serrated-Micro |
| 26 cm | |
- Serrated-Solid

Ryder French-Eye/Standard/Micro Needle Holders T.C



- | |
|------------------|
| 07-339 |
| 12.5 cm |
| Tungsten Carbide |
| Serrated-Solid |

Converse Needle Holders



- | |
|------------------|
| 07-340 |
| 12 cm |
| Tungsten Carbide |
| Serrated-Solid |

Derf Needle Holders T.C

Nadelhalter | Porta-agujas
 Prote-aiguilles | Porta aghi



De Bakey Needle Holders T.C
 07-341 18 cm
 07-342 20 cm
 07-343 22 cm
 07-344 25 cm



Debakay Cardiovascular Needle Holders T.C
 Delicate patterns. serrated.

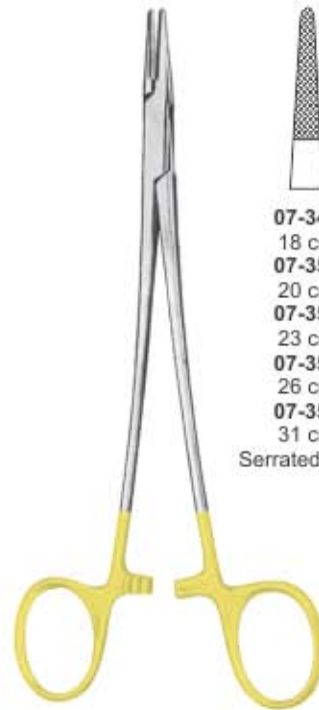

Debakay-Vascular/Extra Light Needle Holders T.C



Gillies Slim T.c Needle Holders with Scissors

07-345 18 cm
 07-346 23 cm
 07-347 26 cm
 07-348 30 cm

07-349 18 cm
 07-350 20 cm
 07-351 23 cm
 07-352 26 cm
 07-353 31 cm
 Serrated-Solid

07-354 15cm



Wire Twisters Needle Holders T.C

07-355 15 cm Delicate.
 07-356 15 cm
 07-357 18 cm
 07-358 20 cm Heavy



Sternum Needle Holders T.C

07-359 18 cm Wire Twister



Cooley-Baumgaften Wire Twister Needle Holders T.C
 Extra heavy needle holder designed for twisting of wire and placement of retention suture. Heavy, blunt jaws.

07-360 20 cm

Nadelhalter | Porta-agujas
Prote-aiguilles | Porta aghi



07-361
12.5 cm



07-362
12.5 cm

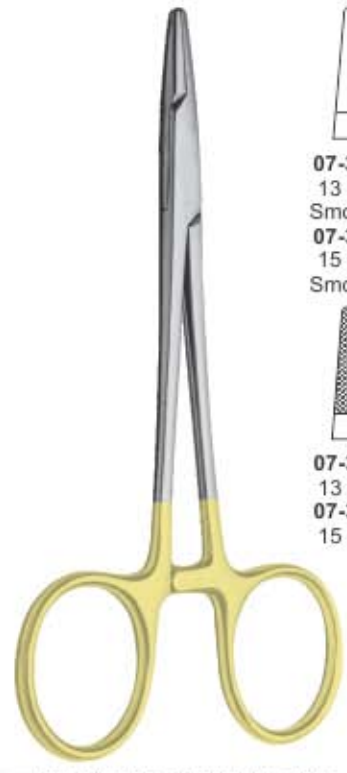

07-363
13 cm
Smooth
07-364
15 cm
Smooth
07-365
13 cm
07-366
15 cm

**Rubio Wire Twister
Needle Holders T.C**

Neivert Needle Holders T.C

Webster Needle Holders T.C

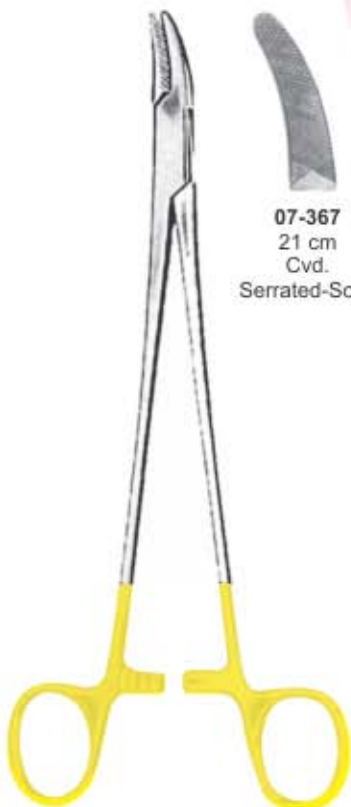

07-367
21 cm
Cvd.
Serrated-Solid

07-368
24 cm
Cvd.
Tungsten
Carbide
Serrated-Solid

07-369
26 cm
Cvd.
Tungsten
Carbide
Serrated-Solid

Heaney-Gyne Needle Holders T.C



**Wire Tightening
Needle Holders T.C**
07-370 18 cm



07-371
20 cm
Straight

07-372
20 cm
Curved

Julian Needle Holders T.C

Nadelhalter | Porta-agujas
 Prote-aiguilles | Porta aghi



07-373
27 cm



07-374
30 cm



07-375
15 cm
07-376
17 cm
07-377
20 cm



07-378
20 cm
07-379
25 cm

Masson Needle Holders T.C **O'Brien Needle Holders T.C**

Martin
Needle Holder mini profile elastic type

Thomson-Walker
Needle Holders T.C



Hepp-Scheidel
07-380
Micro Needle Holder smooth jaw
18 cm,



Lichtenberg
07-381 20 cm
Needle Holder lightweight model
standard profile



07-382
18 cm
07-383
22 cm

Castroviejo Needle
Holder T.C



07-384
14 cm
Straight

07-385
14 cm
Curved

Castroviejo Needle
Holder T.C

Nadelhalter | Porta-agujas
Prote-aguilles | Porta aghi



07-386
18 cm
Smooth

07-388
21 cm
Smooth



07-387
21 cm
Smooth

07-389
21 cm
Serrated-Solid



07-390
14 cm
Straight
Smooth
fine tip

07-394
14 cm
07-395
18 cm
Straight
Serrated-Solid
fine tip

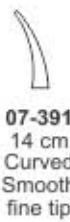

07-391
14 cm
Curved
Smooth
fine tip

07-396
14 cm
07-397
18 cm
Curved
Serrated-Solid
fine tip



07-392
14 cm
Straight
Serrated-Solid
fine tip



07-393
14 cm
Straight
Smooth
regular tip



Micro Needle Holder
07-398 15 cm
07-399 18 cm
07-400 21 cm
07-401 23 cm

MANZIM
SURGICO



Toennis Needle Holders T.C
07-402 18.5 cm



Boynton Needle Holders T.C
07-403 12 cm



Arruga Needle Holders T.C
07-404 16 cm Str.
07-405 16 cm Cvd.



Spencer Coronary Needle Holders T.C
07-406 18 cm



Jaboma
07-407
Micro Needle Holder
18 cm

Nadelhalter | Porta-agujas
 Prote-aiguilles | Porta aghi



Castroviejo Micro Needle Holder
 07-408 14.5 cm
 07-409 18 cm
 07-410 21.5 cm



Barraquer
 07-411
 Micro Needle Holder
 13 cm



Barraquer
 07-412
 Micro Needle Holder
 13 cm



Mathieu Needle Holder
 07-413 14 cm
 07-414 17 cm
 07-415 20 cm



Mathieu Needle Holder
 07-416 14 cm
 07-417 17 cm
 07-418 20 cm



Mathieu Needle Holder
 07-419 17 cm
 07-420 20 cm
 07-421 23 cm
 standard profile with interior
 ratchet



Castroviejo
 07-422
 Micro Needle Holder
 12.5 cm



Kalt Needle Holders T.C
 07-423 14 cm Str.



07-424
 17 cm
 07-425
 20 cm
 07-426
 24 cm

**Mathieu-Ryder Needle
 Holders T.C**

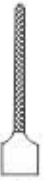

07-427
 17 cm
 07-428
 20 cm
 07-429
 24 cm

**Mathieu-Ryder Vascular
 Needle Holders T.C**

Nadelhalter
Prote-aiguilles

Porta-agujas
Porta aghi



07-430
15 cm

07-432
17 cm

07-431
15 cm



07-433
20 cm



**Langenbeck
Needle
Holders T.C**
07-434
16 cm
07-435
18 cm
07-436
20 cm

**Langenbeck-
Delicate
Needle
Holders T.C**
07-437
18 cm
07-438
20 cm
07-439
23 cm

**Langenbeck-
Ryder
Needle
Holders T.C**
07-440
18 cm
07-441
20 cm
07-442
23 cm

Corwin Needle Holders T.C

Lichtenberg Needle Holders T.C

MANZIM
SURGICO



07-443
20 cm

07-444
23 cm

07-445
18.5 cm



07-446
20 cm

Zweifel Needle Holders T.C

Eiselsberg-Matheiu
Needle Holders T.C

Luethy-Beck
Needle Holders T.C

Reverdin nadeln
aguja de reverdin

Aguilles de reverdin
aghi di reverdin



Reverdin Needle
short



07-447
14.5 cm



07-448
14.5 cm



07-449
14.5cm



07-450
14.5cm



21cm



2
07-451



1
07-452



4
07-453



3
07-454



Reverdin Needle
19.5 cm



07-455
19.5cm
07-456
23cm



07-457
19.5cm
07-458
23cm



07-459
19.5cm
07-460
23cm



07-461
19.5cm
07-462
23cm



Reverdin Needle
23 cm



07-463
25cm



07-464
23cm
07-465
28cm



Konig
07-466
20 cm



Payr
07-467
22 cm



Konig Ligature
Conductor



07-468
19.5cm
/ 3 mm



Michel
07-469

REVERDIN NEEDLES

Reverdin nadeln
aguja de reverdin

Aguilles de reverdin
aghi di reverdin



07-471
Needle No. 01

07-472
Needle No. 02

Young Needle 07-470
24.5 cm
Complete with on Needle no. 00 01, 02, 03

07-473
Needle No. 03



Schmieden-Dick Needle 07-474
29cm malleable



Schmieden Needle 07-475
24cm

Ligature Needle 07-476
20 cm

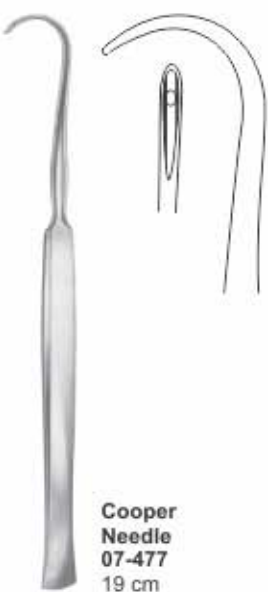

Cooper Needle 07-477
19 cm

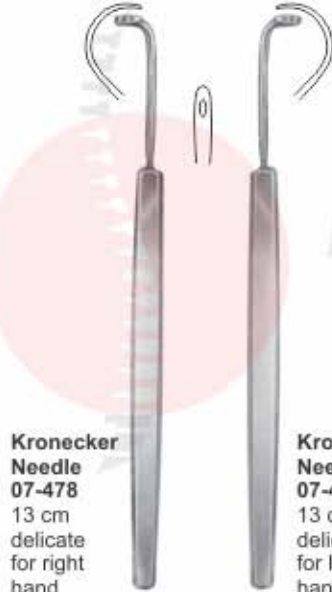

Kronecker Needle 07-478
13 cm delicate for right hand

Kronecker Needle 07-479
13 cm delicate for left hand



Deschamps Needle 07-480
24 cm

Deschamps Needle 07-481
24 cm



07-482
20cm sharp for right hand

07-483
20cm sharp for left hand

Deschamps Needle



07-484
27cm blunt for right hand

07-485
27cm blunt for left hand

Deschamps Needle



07-486
27cm sharp for right hand

07-487
27cm sharp for left hand

Deschamps Needle

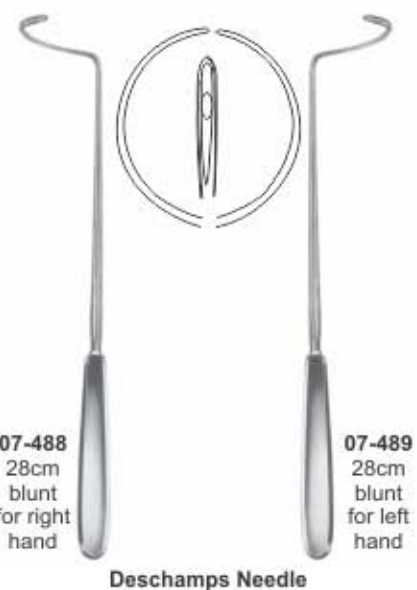

07-488
28cm blunt for right hand

07-489
28cm blunt for left hand

Deschamps Needle

Unterbindungsnadeln
agujas para ligaduras

Aiguilles à ligatures
aghi di legatura



Deschamps Needle
07-490 20cm sharp for right hand
07-491 20cm sharp for left hand



Deschamps Needle
07-492 20cm blunt for right hand
07-493 20cm blunt for left hand



Deschamps Needle
07-494 21cm blunt for right hand
07-495 21cm blunt for left hand

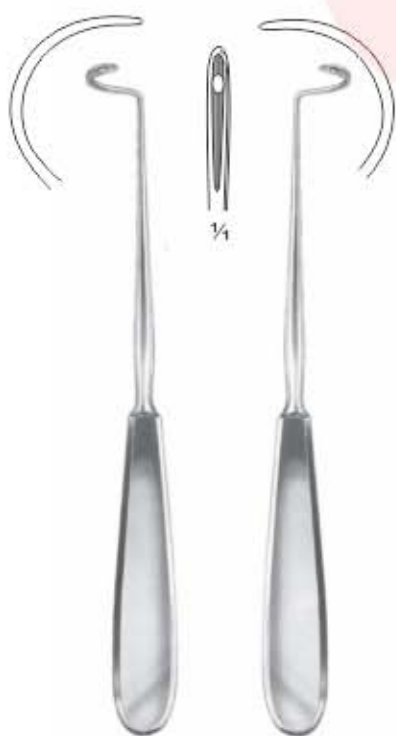

Deschamps Needle
07-496 20cm blunt for right hand
07-497 20cm blunt for left hand



Deschamps Needle
07-498 20cm sharp for right hand
07-499 20cm sharp for left hand



Deschamps Needle
07-500 20cm blunt for right hand
07-501 20cm blunt for left hand

Reverdin nadeln
aguja de reverdin

Aguilles de reverdin
aghi di reverdin



SURGEONS NEEDLES

- 07-502 Fistula Needle, 1/2 Circle, Cutting Edge, #00
- 07-503 Fistula Needle, 1/2 Circle, Cutting Edge, #0
- 07-504 Fistula Needle, 1/2 Circle, Cutting Edge, #1
- 07-505 Fistula Needle, 1/2 Circle, Cutting Edge, #2
- 07-506 Fistula Needle, 1/2 Circle, Cutting Edge, #3
- 07-507 Fistula Needle, 1/2 Circle, Cutting Edge, #4
- 07-508 Fistula Needle, 1/2 Circle, Cutting Edge, #5
- 07-509 Fistula Needle, 1/2 Circle, Cutting Edge, #6
- 07-510 Fistula Needle, 1/2 Circle, Cutting Edge, #7
- 07-511 Fistula Needle, 1/2 Circle, Cutting Edge, #8
- 07-512 Fistula Needle, 1/2 Circle, Cutting Edge, #9

- 07-513 Regular Surgeons Needle, 1/2 Circle, Cutting Edge, #0
- 07-514 Regular Surgeons Needle, 1/2 Circle, Cutting Edge, #1
- 07-515 Regular Surgeons Needle, 1/2 Circle, Cutting Edge, #2
- 07-516 Regular Surgeons Needle, 1/2 Circle, Cutting Edge, #3
- 07-517 Regular Surgeons Needle, 1/2 Circle, Cutting Edge, #4
- 07-518 Regular Surgeons Needle, 1/2 Circle, Cutting Edge, #5
- 07-519 Regular Surgeons Needle, 1/2 Circle, Cutting Edge, #6
- 07-520 Regular Surgeons Needle, 1/2 Circle, Cutting Edge, #7
- 07-521 Regular Surgeons Needle, 1/2 Circle, Cutting Edge, #8
- 07-522 Regular Surgeons Needle, 1/2 Circle, Cutting Edge, #9
- 07-523 Regular Surgeons Needle, 1/2 Circle, Cutting Edge, #10
- 07-524 Regular Surgeons Needle, 1/2 Circle, Cutting Edge, #11
- 07-525 Regular Surgeons Needle, 1/2 Circle, Cutting Edge, #12
- 07-526 Regular Surgeons Needle, 1/2 Circle, Cutting Edge, #13
- 07-527 Regular Surgeons Needle, 1/2 Circle, Cutting Edge, #14
- 07-528 Regular Surgeons Needle, 1/2 Circle, Cutting Edge, #15
- 07-529 Regular Surgeons Needle, 1/2 Circle, Cutting Edge, #16
- 07-530 Regular Surgeons Needle, 1/2 Circle, Cutting Edge, #17
- 07-531 Regular Surgeons Needle, 1/2 Circle, Cutting Edge, #18
- 07-532 Regular Surgeons Needle, 1/2 Circle, Cutting Edge, #19
- 07-533 Regular Surgeons Needle, 1/2 Circle, Cutting Edge, #20

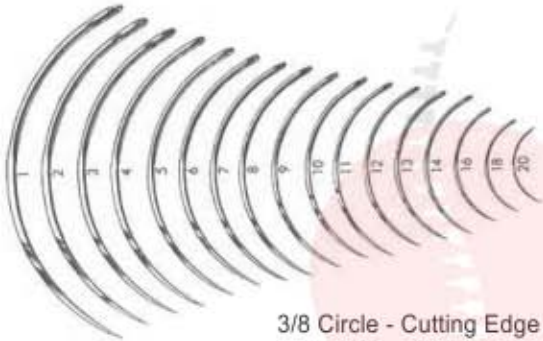

3/8 Circle - Cutting Edge

SURGEONS NEEDLES

- 07-534 Regular Surgeons Needle, 3/8 Circle, Cutting Edge, #1
- 07-535 Regular Surgeons Needle, 3/8 Circle, Cutting Edge, #2
- 07-536 Regular Surgeons Needle, 3/8 Circle, Cutting Edge, #3
- 07-537 Regular Surgeons Needle, 3/8 Circle, Cutting Edge, #4
- 07-538 Regular Surgeons Needle, 3/8 Circle, Cutting Edge, #5
- 07-539 Regular Surgeons Needle, 3/8 Circle, Cutting Edge, #6
- 07-540 Regular Surgeons Needle, 3/8 Circle, Cutting Edge, #7
- 07-541 Regular Surgeons Needle, 3/8 Circle, Cutting Edge, #8
- 07-542 Regular Surgeons Needle, 3/8 Circle, Cutting Edge, #9
- 07-543 Regular Surgeons Needle, 3/8 Circle, Cutting Edge, #10
- 07-544 Regular Surgeons Needle, 3/8 Circle, Cutting Edge, #11
- 07-545 Regular Surgeons Needle, 3/8 Circle, Cutting Edge, #12
- 07-546 Regular Surgeons Needle, 3/8 Circle, Cutting Edge, #13
- 07-547 Regular Surgeons Needle, 3/8 Circle, Cutting Edge, #14
- 07-548 Regular Surgeons Needle, 3/8 Circle, Cutting Edge, #15
- 07-549 Regular Surgeons Needle, 3/8 Circle, Cutting Edge, #16
- 07-550 Regular Surgeons Needle, 3/8 Circle, Cutting Edge, #17
- 07-551 Regular Surgeons Needle, 3/8 Circle, Cutting Edge, #18
- 07-552 Regular Surgeons Needle, 3/8 Circle, Cutting Edge, #19
- 07-553 Regular Surgeons Needle, 3/8 Circle, Cutting Edge, #20



Keith Abdominal Straight, Triangular Point

- 07-566 Keith Abdominal Needles, Straight, Triangular Point, 4"
- 07-567 Keith Abdominal Needles, Straight, Triangular Point, 3-1/2"
- 07-568 Keith Abdominal Needles, Straight, Triangular Point, 3"
- 07-569 Keith Abdominal Needles, Straight, Triangular Point, 2-7/8"
- 07-570 Keith Abdominal Needles, Straight, Triangular Point, 2-1/8"
- 07-571 Keith Abdominal Needles, Straight, Triangular Point, 2"
- 07-572 Keith Abdominal Needles, Straight, Triangular Point, 1-3/4"
- 07-573 Keith Abdominal Needles, Straight, Triangular Point, 1-1/2"

SURGEONS NEEDLES

- 07-554 Regular Surgeons Needles, 1/2 Curved, Cutting Edge, #0
- 07-555 Regular Surgeons Needles, 1/2 Curved, Cutting Edge, #1
- 07-556 Regular Surgeons Needles, 1/2 Curved, Cutting Edge, #2
- 07-557 Regular Surgeons Needles, 1/2 Curved, Cutting Edge, #4
- 07-558 Regular Surgeons Needles, 1/2 Curved, Cutting Edge, #6
- 07-559 Regular Surgeons Needles, 1/2 Curved, Cutting Edge, #8
- 07-560 Regular Surgeons Needles, 1/2 Curved, Cutting Edge, #10
- 07-561 Regular Surgeons Needles, 1/2 Curved, Cutting Edge, #12
- 07-562 Regular Surgeons Needles, 1/2 Curved, Cutting Edge, #14
- 07-563 Regular Surgeons Needles, 1/2 Curved, Cutting Edge, #16
- 07-564 Regular Surgeons Needles, 1/2 Curved, Cutting Edge, #20
- 07-565 Regular Surgeons Needles, 1/2 Curved, Cutting Edge, #22



half Curved - Cutting Edge

Reverdin nadeln
aguja de reverdin

Aguilles de reverdin
aghi di reverdin

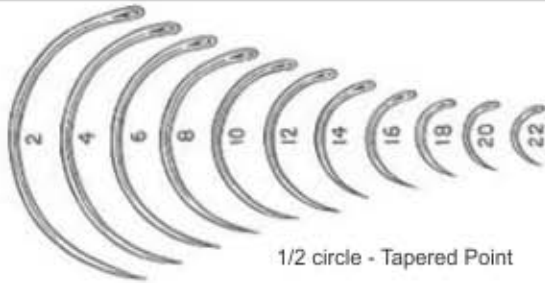

1/2 circle - Tapered Point

- 07-574 Regular Surgeons Needles, 1/2 Curved, Tapered Point, #2
- 07-575 Regular Surgeons Needles, 1/2 Curved, Tapered Point, #4
- 07-576 Regular Surgeons Needles, 1/2 Curved, Tapered Point, #6
- 07-577 Regular Surgeons Needles, 1/2 Curved, Tapered Point, #8
- 07-578 Regular Surgeons Needles, 1/2 Curved, Tapered Point, #10
- 07-579 Regular Surgeons Needles, 1/2 Curved, Tapered Point, #12
- 07-580 Regular Surgeons Needles, 1/2 Curved, Tapered Point, #14
- 07-581 Regular Surgeons Needles, 1/2 Curved, Tapered Point, #16
- 07-582 Regular Surgeons Needles, 1/2 Curved, Tapered Point, #18
- 07-583 Regular Surgeons Needles, 1/2 Curved, Tapered Point, #20
- 07-584 Regular Surgeons Needles, 1/2 Curved, Tapered Point, #22



3/8 circle - cutting edge

- SURGEONS NEEDLES**
- A 07-585 Veterinary Needles, 3/8 Circle, Cutting Edge, #1
 - 07-586 Veterinary Needles, 3/8 Circle, Cutting Edge, #2
 - 07-587 Veterinary Needles, 3/8 Circle, Cutting Edge, #3
 - 07-588 Veterinary Needles, 3/8 Circle, Cutting Edge, #4
 - 07-589 Veterinary Needles, 3/8 Circle, Cutting Edge, #5
 - 07-590 Veterinary Needles, 3/8 Circle, Cutting Edge, #6
 - 07-591 Veterinary Needles, 3/8 Circle, Cutting Edge, #7
 - 07-592 Veterinary Needles, 3/8 Circle, Cutting Edge, #8



double curved - cutting edge

- B 07-593 Post Mortem Needles, Double Curve Cutting Edge, Size 1
- 07-594 Post Mortem Needles, Double Curve Cutting Edge, Size 2
- 07-595 Post Mortem Needles, Double Curve Cutting Edge, Size 3
- 07-596 Post Mortem Needles, Double Curve Cutting Edge, Size 4
- 07-597 Post Mortem Needles, Double Curve Cutting Edge, Size 5
- 07-598 Post Mortem Needles, Double Curve Cutting Edge, Size 6
- 07-599 Post Mortem Needles, Double Curve Cutting Edge, Size 7
- 07-600 Post Mortem Needles, Double Curve Cutting Edge, Size 8

SURGEONS NEEDLES

- A 07-601 Martin Uterine Needles, 1/2 Curved Cutting Edge, #1
- 07-602 Martin Uterine Needles, 1/2 Curved Cutting Edge, #2
- 07-603 Martin Uterine Needles, 1/2 Curved Cutting Edge, #3
- 07-604 Martin Uterine Needles, 1/2 Curved Cutting Edge, #4
- 07-605 Martin Uterine Needles, 1/2 Curved Cutting Edge, #5
- 07-606 Martin Uterine Needles, 1/2 Curved Cutting Edge, #6
- 07-607 Martin Uterine Needles, 1/2 Curved Cutting Edge, #7
- 07-608 Martin Uterine Needles, 1/2 Curved Cutting Edge, #8
- B 07-609 Lane Cleft Palate, 1/2 Circle, Cutting Edge, #1
- 07-610 Lane Cleft Palate, 1/2 Circle, Cutting Edge, #2
- 07-611 Lane Cleft Palate, 1/2 Circle, Cutting Edge, #3
- 07-612 Lane Cleft Palate, 1/2 Circle, Cutting Edge, #4
- 07-613 Lane Cleft Palate, 1/2 Circle, Cutting Edge, #5
- C 07-614 Post Mortem Needles, Half Curved Cutting Edge, Size 1
- 07-615 Post Mortem Needles, Half Curved Cutting Edge, Size 2
- 07-616 Post Mortem Needles, Half Curved Cutting Edge, Size 3
- 07-617 Post Mortem Needles, Half Curved Cutting Edge, Size 4
- 07-618 Post Mortem Needles, Half Curved Cutting Edge, Size 5
- 07-619 Post Mortem Needles, Half Curved Cutting Edge, Size 6



Martin, 1/2 Circle Cutting Edge

A



Left Cleft Palate, 1/2 Circle Cutting Edge

B



Post Mortem - Half Curved Cutting Edge

C

RETRACTORS INSTRUMENTS

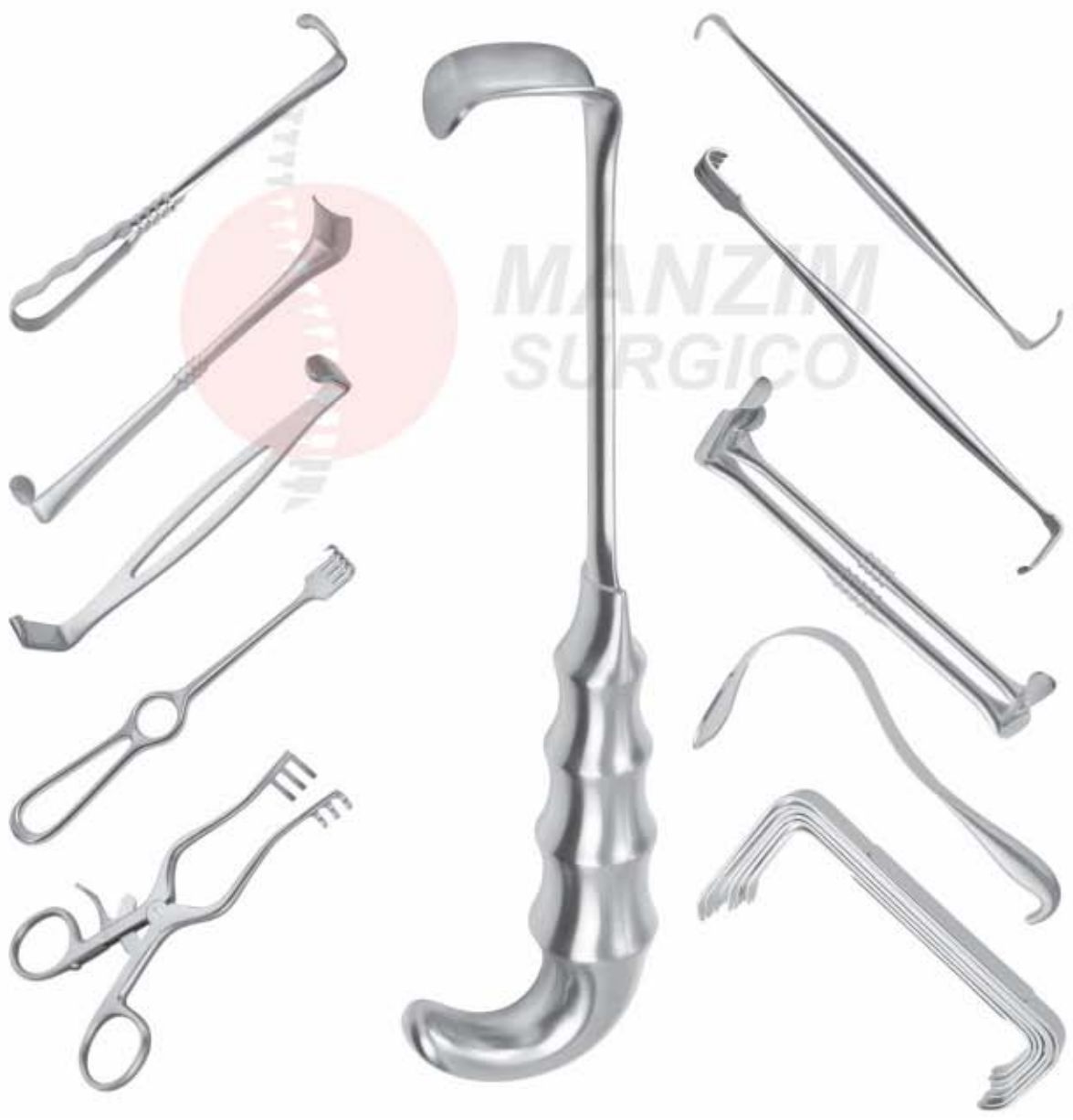

Wundhäkchen, Mikrohäkchen | Crochet, Micro crochetes
 Ganchito, Micro Ganchitos | Divaricatore, Micro Divaricatori

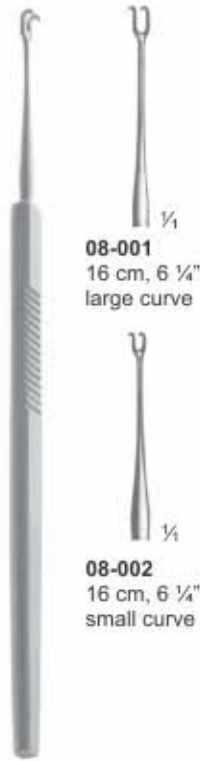

08-001
 16 cm, 6 1/4"
 large curve

08-002
 16 cm, 6 1/4"
 small curve

GUTHRIE HOOKLET



08-003
 18 cm, 7"
 Sharp

08-004
 18 cm, 7"
 sharp

GILLIES SKIN HOOK



08-005
 15 cm, 6"
 sharp

KILNER HOOK



08-006
 18.5 cm, 7 1/4"
 sharp

08-007
 18.5 cm, 7 1/4"
 sharp

FISCH HOOKLET & Skin Hook



08-008
 13 cm, 5"
08-009
 18 cm, 7"
 Blunt

08-010
 13 cm, 5"
08-011
 18 cm, 7"
 Sharp

FRAZIER HOOKLET & Skin Hook



DOUBLE PRONG MICRO HOOK & Skin Hook
08-012
 Sharp, 2mm, wide jaws,
 14.5 cm, 6 1/4"



WIENER HOOK & Skin Hook
08-013
 Sharp,
 14 cm, 5 1/2"



TOENNIS HOOK & Skin Hook
08-014
 Sharp
 15 cm, 6"
 Sharp



08-015
 2 sharp prong
 13 cm, 5"
 2.25mm diameter
 3mm wide

08-016
 4 sharp prong
 13 cm, 5"
 2mm diameter
 5mm wide

08-017
 4 blunt prong
 13 cm, 5"
 2mm diameter
 5mm wide

ROLLET HOOK



08-018
 15 cm, 6", sharp
 double prongs
 2.5mm wide

08-019
 15 cm, 6", blunt
 double prongs
 2.5mm wide

FREER SKIN HOOK

Wundhäkchen, Mikrohäkchen | Crochet, Micro crochetes
Ganchito, Micro Ganchitos | Divaricatore, Micro Divaricatori



CRILE HOOKLET & SKIN HOOKS
08-020 20.4 cm, 8"



VON GRAEFE Strabismus & SKIN HOOKS
08-021 13.0 cm, 5" - A
08-022 14.0 cm, 5 1/2" - B
08-023 15.0 cm, 6" - C



WAGENER HOOKLET & SKIN HOOKS
08-024 14 cm, 5 1/2" - A
08-025 14 cm, 5 1/2" - B
08-026 14 cm, 5 1/2" - C
08-027 14 cm, 5 1/2" - D



DAY HOOKLET & SKIN HOOKS
08-028 16 cm, 6 1/4" - A
08-029 16 cm, 6 1/4" - B

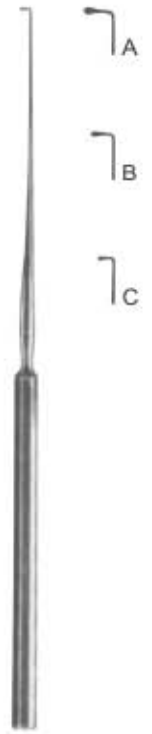

LUCAE HOOKLET & SKIN HOOKS
08-030 14 cm, 5 1/2" - A
08-031 14 cm, 5 1/2" - B
08-032 14 cm, 5 1/2" - C



Converse Hook
08-033
12 cm, 5"

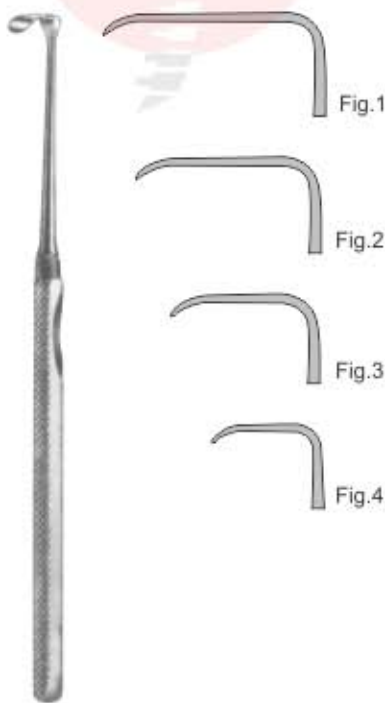

MANNERFELT-LANGENBECK HOOK
08-034 15 x 6 mm 15.5 cm, 6" Fig.1
08-035 20 x 6 mm 15.5 cm, 6" Fig.2
08-036 25 x 6 mm 15.5 cm, 6" Fig.3
08-037 30 x 8 mm 15.5 cm, 6" Fig.4



MANNERFELT HOOK
15.5 cm, 6"
large curve, single
hook



Brom Hooklet Retractors
08-041
17 cm, 6 3/4"

Hooklet Retractors
08-042
13 cm, 5"

HOOKLET, RETRACTORS

Wundhäkchen, Wundhaken
Ganchito, Separadores

Crochet, Ecarteurs
Divaricatore, Divaricatori



Tracheal Retractor
18 cm

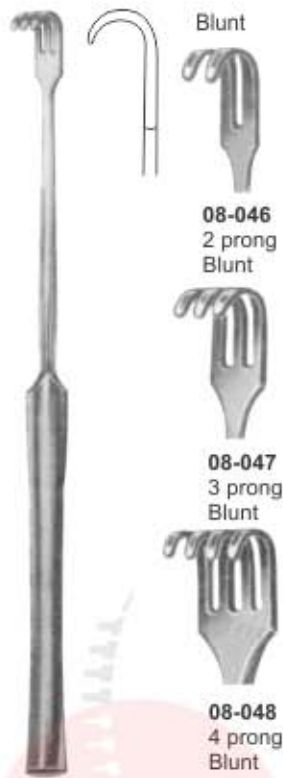

Tracheal Retractor
18 cm

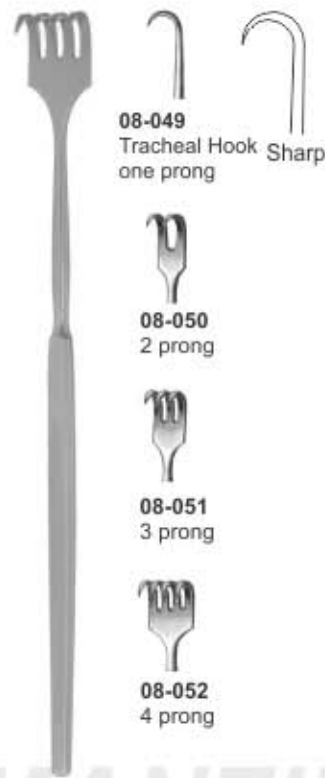

Trachea Retractor
16.5 cm Sharp

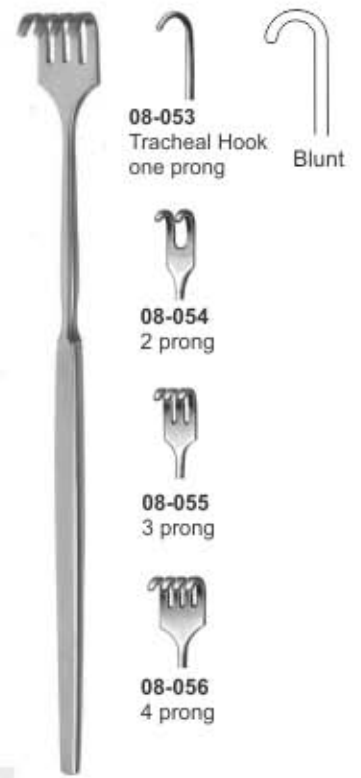

Tracheal Retractor
16.5 cm Blunt



Rollet Hooklet Retractors
08-057
12.5cm

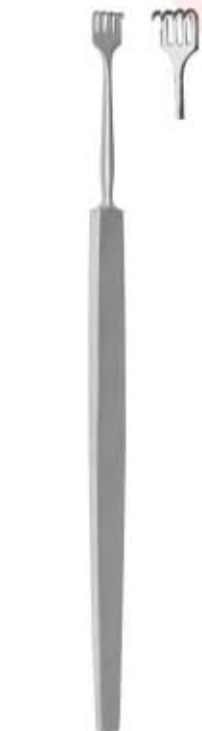

Rollet (Blair) Hooklet Retractors
08-058
13.5cm



Paul Hooklet Retractors
08-059
12.5cm



Paul Hooklet Retractors
08-060
16cm



Miller Retractor
08-061
13.5cm
Sharp 6 prong



Miller Retractor
13.5 cm

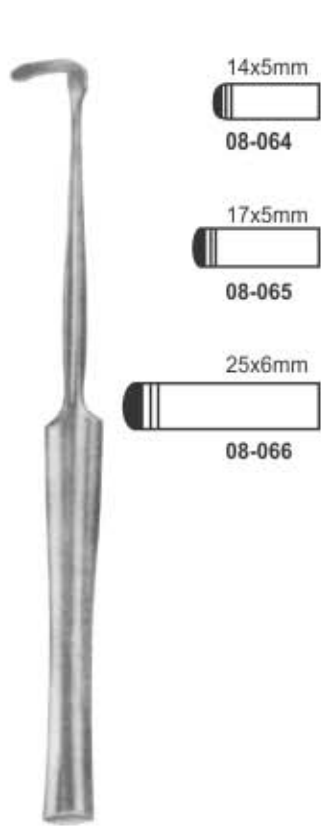

Hooklet Retractors
17 cm

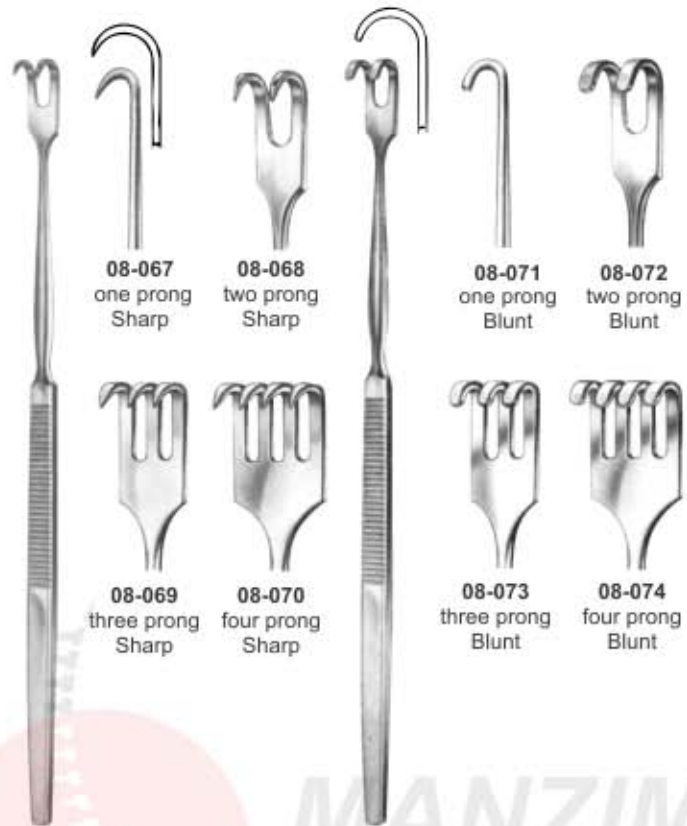

Finger Rake, Retractor
16.5 cm

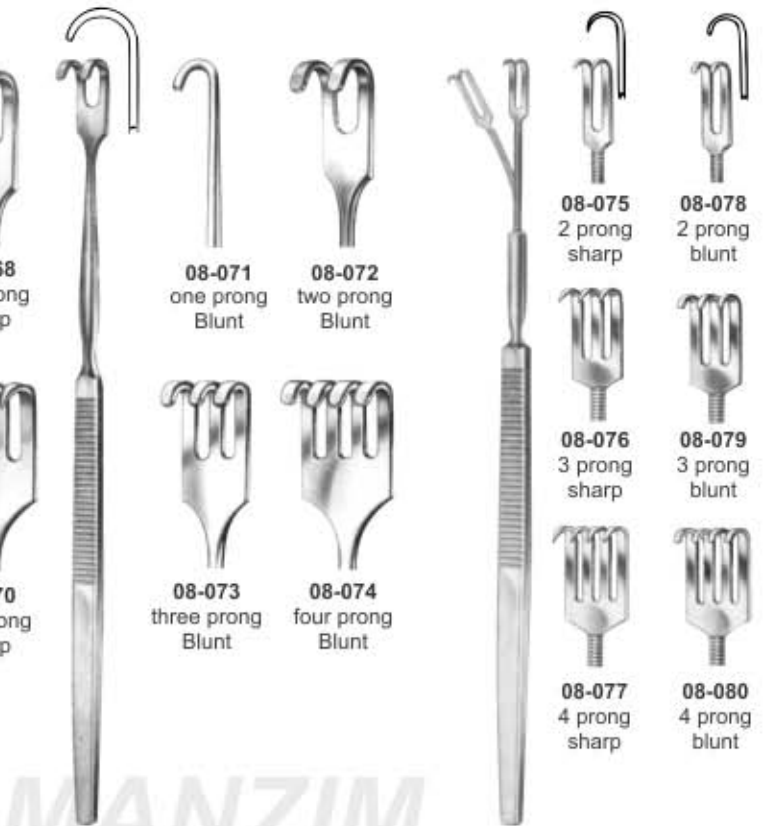

Hooklets, Retractors
flexible,
16 cm



Peck Rake Retractor
16.5 cm



Kocher Hooklet, Retractors



Kocher Hooklet, Retractors

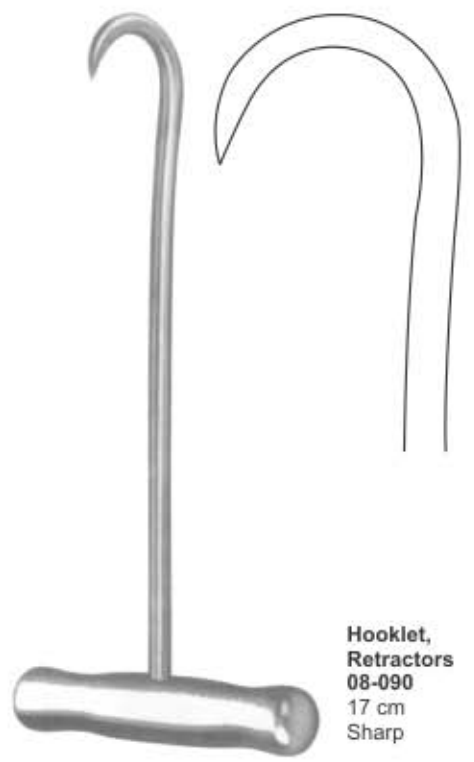

Hooklet, Retractors
08-090
17 cm
Sharp

HOOKLET, RETRACTORS

Wundhäkchen, Wundhaken
Ganchito, Separadores

Crochet, Ecarteurs
Divaricatore, Divaricatori



Volkman Retractors
08-091 23 cm
Sharp



Volkman Retractors
08-092 23 cm
Blunt



08-093
13 x 235 mm
08-094
20 x 255 mm
08-095
27 x 270 mm



Volkman Retractors
08-096
11.5 cm



Murphy Retractors
19.1 cm 7 1/2"



Senn Retractor
08-108
16 cm 6 1/4"
Blunt



Senn Retractor
08-109
16 cm 6 1/4"
Sharp



Senn-Mueller Retractor
08-110
18 x 6 mm
16 cm, 6 1/4"
sharp



Volkman Retractor
08-111
22 cm 8 3/4"
4 Prongs Sharp



Volkman Retractor
08-112
22 cm 8 3/4"
4 Prongs Blunt

Wundhäkchen, Wundhaken
Ganchito, Separadores

Crochet, Ecarteurs
Divaricatore, Divaricatori



Sternberg Retractor
08-113 12 cm, 4 3/4"
08-114 14 cm, 5 1/2"
08-115 16 cm, 6 1/4"



Collin-Hartmann Retractor
08-116 38 x 28 / 32 x 21 mm 14 cm, 5 1/2"
08-117 52 x 34 / 36 x 27 mm 16 cm, 6 1/4"



Herzfeld Retractor
08-118 20 cm, 8"



Strandell-Stille Retractor
08-119 19 cm, 7 1/2"



Strandell-Stille Retractor
08-120 19 cm, 7 1/2"



Schoenbore Retractor
08-121 21 cm, 8 1/4"



Konig Retractor
17 cm, 6 3/4"



Senn-Green Retractor
15 cm, 6"



Cottle Retractor
08-126 15 cm, 6"
10 x 12 mm



Ragnell-Davis Retractor
08-127 14 cm, 5 1/2"
08-128 8 x 4 mm
15 x 5.5 mm

RETRACTORS

Wundhaken | Ecarteurs
Separadores | Divaricatori

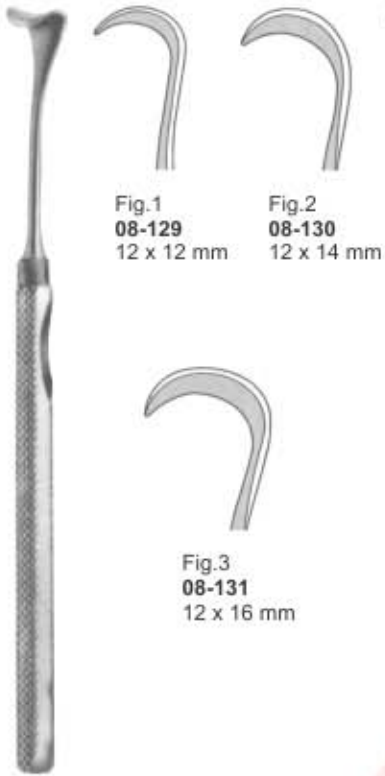

Mannerfelt Hooklet Retractors
15.5cm

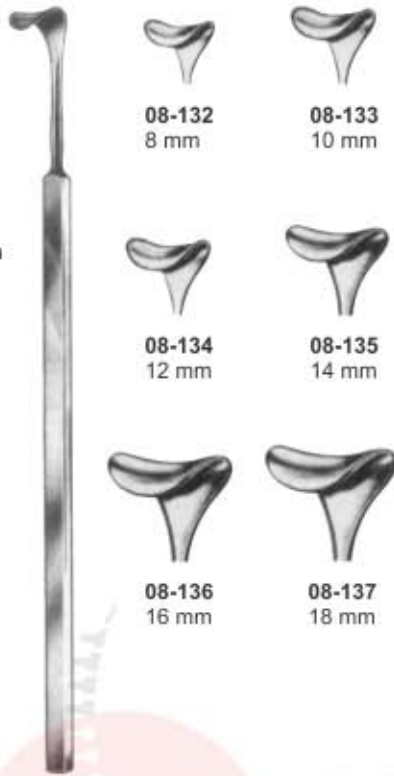

Cushing Hooklet Retractors
20cm

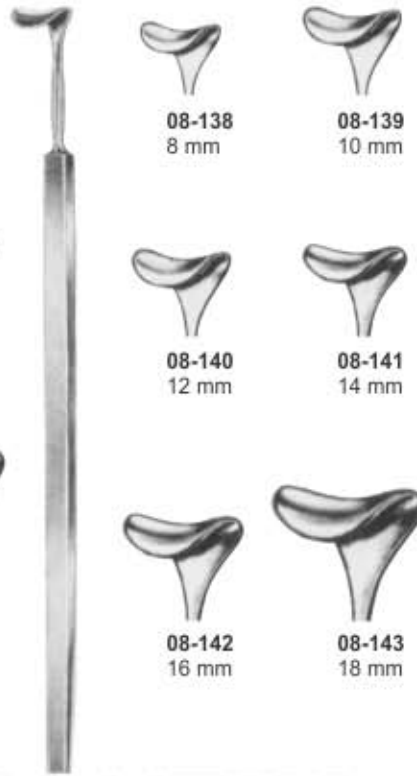

Cushing Hooklet Retractors
24cm



Cushing-Kocher Hooklet Retractors
18 cm

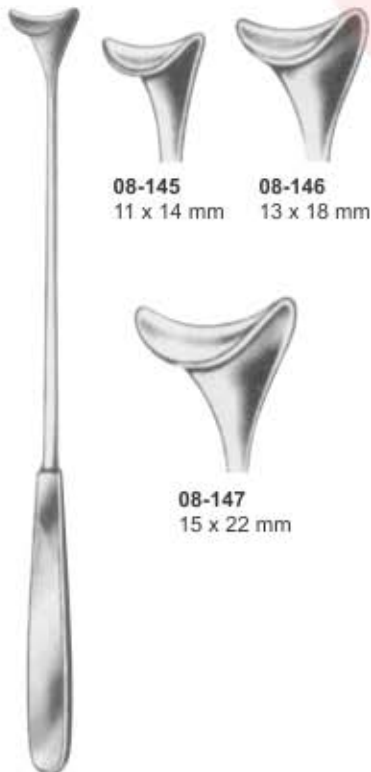

Cushing Hooklet Retractors
24cm

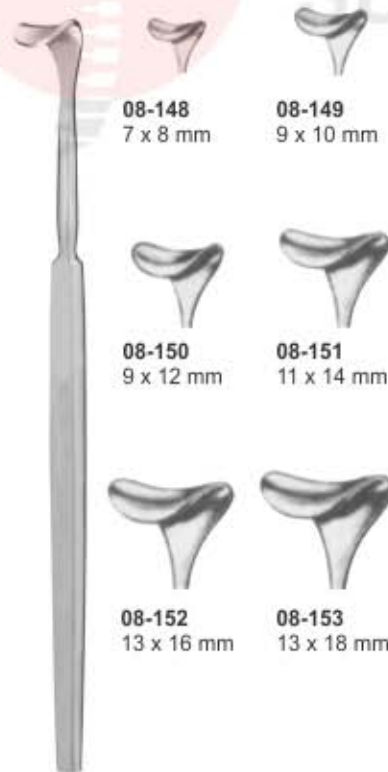

Desmarres Lid Retractors
16cm



Kocher Retractor



Kocher Retractor
22 cm
08-161 40 x 10 mm
08-162 40 x 15 mm
08-163 40 x 20 mm

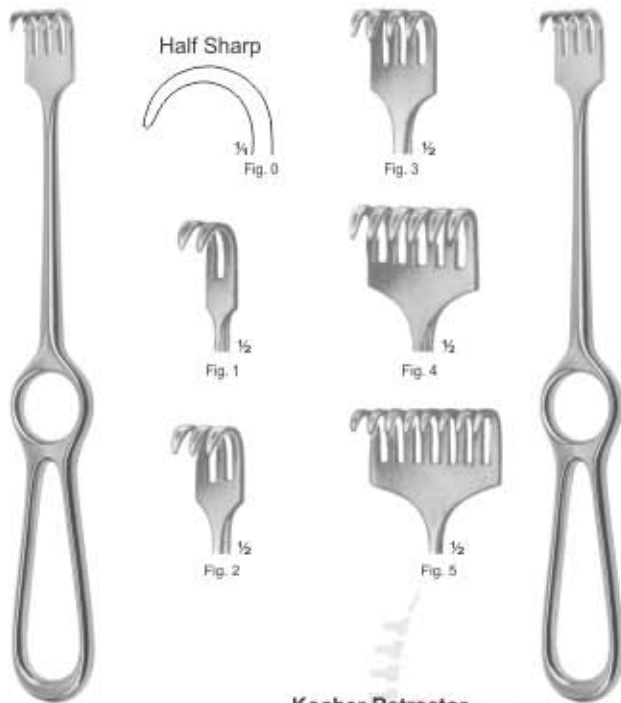

Kocher Retractor

- 08-164 22 cm, 8 3/4" 15 x 10 mm 2 prong Fig. 1
- 08-165 22 cm, 8 3/4" 15 x 15 mm 3 prong Fig. 2
- 08-166 22 cm, 8 3/4" 15 x 20 mm 4 prong Fig. 3
- 08-167 22 cm, 8 3/4" 15 x 30 mm 6 prong Fig. 4
- 08-168 22 cm, 8 3/4" 15 x 40 mm 8 prong Fig. 5

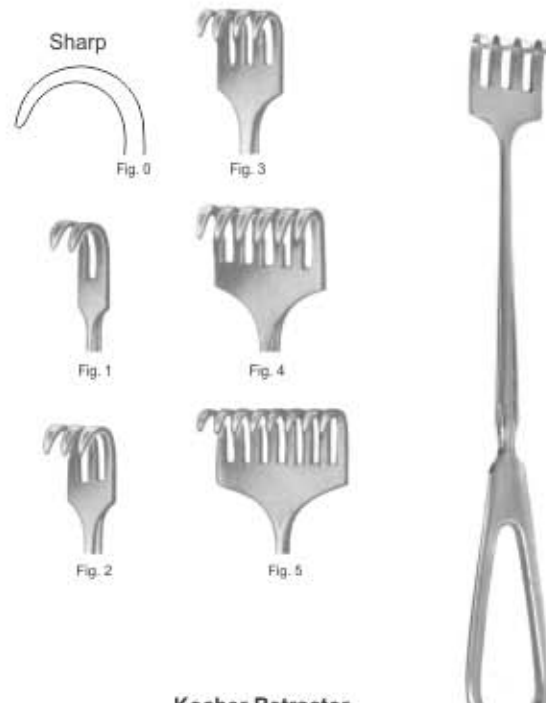

Kocher Retractor

- 08-169 22 cm, 8 3/4" 15 x 10 mm 2 prong Fig. 1
- 08-170 22 cm, 8 3/4" 15 x 15 mm 3 prong Fig. 2
- 08-171 22 cm, 8 3/4" 15 x 20 mm 4 prong Fig. 3
- 08-172 22 cm, 8 3/4" 15 x 30 mm 6 prong Fig. 4
- 08-173 22 cm, 8 3/4" 15 x 40 mm 8 prong Fig. 5



- 08-174 Blunt, 2 prongs.
- 08-175 Blunt, 3 prongs.
- 08-176 Blunt, 4 prongs.
- 08-177 Blunt, 5 prongs.
- 08-178 Blunt, 6 prongs.
- 08-179 Sharp, 2 prongs.
- 08-180 Sharp, 3 prongs.
- 08-181 Sharp, 4 prongs.
- 08-182 Sharp, 5 prongs.
- 08-183 Sharp, 6 prongs.

Volkman Retractors
Long Pattern
22.2 cm, 8 1/4"

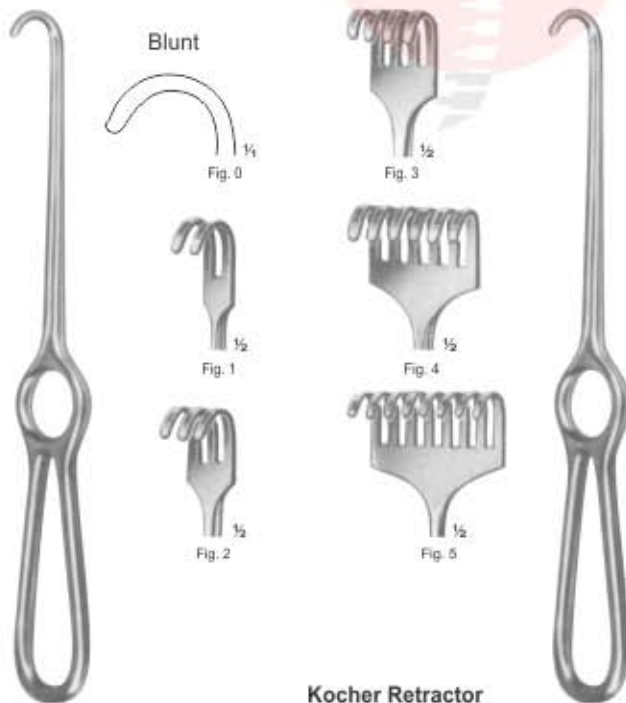

Kocher Retractor

- 08-184 22 cm, 8 3/4" 15 x 10 mm 2 prong Fig. 1
- 08-185 22 cm, 8 3/4" 15 x 15 mm 3 prong Fig. 2
- 08-186 22 cm, 8 3/4" 15 x 20 mm 4 prong Fig. 3
- 08-187 22 cm, 8 3/4" 15 x 30 mm 6 prong Fig. 4
- 08-188 22 cm, 8 3/4" 15 x 40 mm 8 prong Fig. 5



Kocher Retractor

- 08-189 22 cm, 8 3/4" 15 x 10 mm 2 prong Fig. 1
- 08-190 22 cm, 8 3/4" 15 x 15 mm 3 prong Fig. 2
- 08-191 22 cm, 8 3/4" 15 x 20 mm 4 prong Fig. 3
- 08-192 22 cm, 8 3/4" 15 x 30 mm 6 prong Fig. 4
- 08-193 22 cm, 8 3/4" 15 x 40 mm 8 prong Fig. 5



Koerte Retractor
08-195 28cm
25 x 40 mm
semi-sharp

Korte-Wagner Retractor
08-194 28cm
Sharp

RETRACTORS

Wundhaken | Ecarteurs
 Separadores | Divaricatori



Koerte Retractor
 08-197 24cm
 26 x 40 mm
 sharp

25 mm

Koerte Retractor
 08-196 24 cm
 26 x 40 mm
 blunt

Koerte Retractor
 08-198 23cm
 Blunt

Koerte Retractor
 08-199 23cm
 46 x 55 mm
 blunt

Ollier Retractor
 08-200 18.5cm

Lahey Goiter Retractor
 08-201 20.4cm
 Right angle blade, length
 1 inch. With lip.



28x6 mm

Fig. 1

Fig. 2

08-208
 14x17mm

08-209
 20x22mm

08-210
 26x30mm

Lahey Retractor
 08-202 19cm

Tendon Hooks Retractor
 08-203 12 x 6 mm Fig. 1
 08-204 12 x 11 mm Fig. 2
 17.5cm

Klapp Retractor
 08-205 17.5cm
 15 x 11 mm

Little Retractor
 08-206 20cm
 12x14 mm

Wassmund Retractor
 08-207 20cm
 33 x 20mm

Middeldorpf Retractor
 21cm

Wundhaken | Ecarteurs
Separadores | Divaricatori



Kocher Retractor
28 cm 11"



08-211



08-212

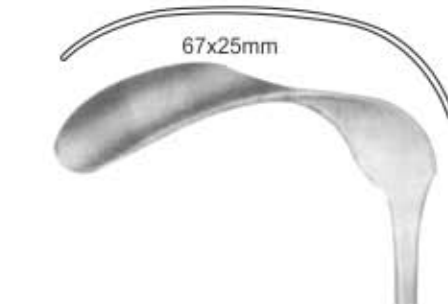

08-213



08-214



Kocher Retractor
08-215
22.5 cm 8 3/4"
70 x 25 mm



MANZIM
SURGICO



Kocher-Wagner Retractor
28 cm, 11"



08-216
22 x 15 mm



08-217
38 x 20 mm



08-218
67 x 25 mm



Kocher Retractor
23 cm, 9"

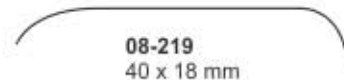

08-219
40 x 18 mm

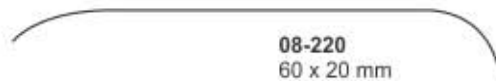

08-220
60 x 20 mm

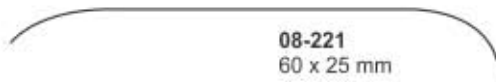

08-221
60 x 25 mm



08-222
75 x 30 mm



08-223
75 x 40 mm

Wundhaken | Ecarteurs
 Separadores | Divaricatori



Kocher-Langenbeck Retractor
 21.5 cm, 8 1/2"



08-224
 25 x 6 mm



08-225
 35 x 8 mm



08-226
 35 x 11 mm



08-227
 35 x 15 mm



08-228
 40 x 11 mm



08-229
 55 x 11 mm



08-230
 70 x 14 mm

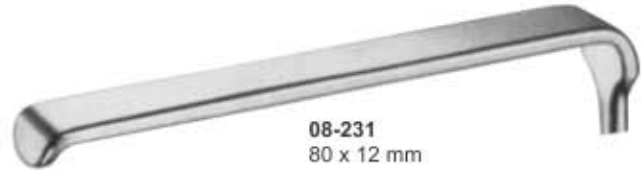

08-231
 80 x 12 mm



08-232
 80 x 16 mm



Langenbeck Retractor
 24 cm, 8 1/4"



08-233
 35 x 7mm



08-234
 35 x 15mm



08-235
 35 x 11mm



08-236
 35 x 20mm



Langenbeck Retractor 08-237
 21.5 cm 8 1/2"
 Handle vertical to the blade



Langenbeck Retractor 08-238
 21 cm 8 1/4"
 38 x 9mm



Caspar Retractor
 21 cm, 8 1/4"



Langenbeck Retractor
20.4 cm, 8"



08-241
20 x 7 mm



08-242
30 x 7 mm



08-243
30 x 11 mm



08-244
30 x 15 mm



08-245
30 x 20 mm



08-246
44 x 10 mm



08-247
44 x 15 mm



08-248
45 x 20 mm

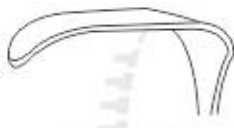

08-249
50 x 20 mm

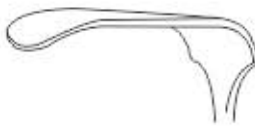

08-250
60 x 20 mm



Meyering Finger Retractor
18 cm, 7"



08-251
long blunt blade,
6 x 17 mm



08-254
long toothed blade,
5 x 16mm



08-252
short toothed blade,
3 x 6 mm



08-255
short blunt blade,
3 x 10mm



08-253
curved blunt blade,
3 x 8mm
Saddle Shaped



08-256
curved three prong
sharp blade,
10 x 4mm



Langenbeck Retractor
22 cm, 8 1/2"



08-257
25 x 6 mm



08-260
35 x 15 mm



08-264
25 x 6 mm



08-267
35 x 15 mm



08-258
35 x 8 mm



08-261
41 x 11 mm



08-265
35 x 8 mm



08-268
41 x 11 mm



08-259
35 x 11 mm



08-262
55 x 11 mm



08-266
35 x 11 mm



08-269
55 x 11 mm



08-263
70 x 14 mm



Langenbeck Retractor
22 cm, 8 1/2"



08-270
70 x 14 mm

Wundhaken | Ecarteurs
 Separadores | Divaricatori



Blount Knee Retractor
08-271 17.5 cm, 6 3/4"
 42 x 4 mm



Taylor Spinal Retractors
08-272 16.5 cm, 6 1/2"
 75 x 30 mm / 100 x 30 mm



Luer Retractor
08-273 11 cm, 4 1/4"
 10 x 8 mm / 12 x 11 mm



Rose Retractor
08-274 13 cm, 5"
 12 x 12 mm /
 12 x 15 mm



20 x 6 mm

12 x 4 mm

Crile Retractor
08-275 11 cm, 4 1/4"
 12 x 4 mm /
 20 x 6 mm



Mathieu Retractor
 Set 2 pcs.
08-276 20 cm, 8"
 47 x 13 / 46 x 26 mm
08-277 20 cm, 8"
 42 x 13 / 42 x 26 mm



Us-Army Retractor
 Set 2 pcs.
08-278 21.5 cm, 8 1/2"
 28 x 15 / 42 x 15 mm
08-279 21.5 cm, 8 1/2"
 25 x 15 / 38 x 15 mm



Richardson Eastman Retractor
08-280
 26 cm, 10 1/4"
 small



Richardson Eastman Retractor
08-281
 28 cm, 11"

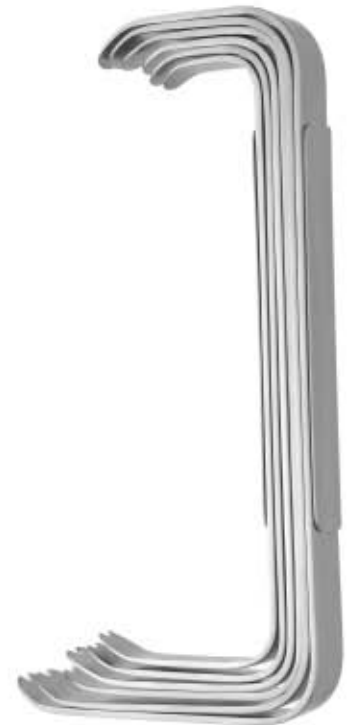

Sofield Retractor
08-282
 set of 6 pec.



Roux Retractor

Set 3 pcs. consisting of
08-283 14 cm, 5 1/2" 24 x 20 / 30 x 28 mm
08-284 15 cm, 6" 29 x 26 / 36 x 36 mm
08-285 17 cm, 6 3/4" 33 x 29 / 38 x 43 mm

Baby-Roux Retractor

08-286 13 cm, 5" 15 x 15 mm / 18 x 21 mm

Roux Retractor

08-287 16.5 cm, 6 1/2" 28 x 23 mm / 43 x 23 mm

Roux Retractor

08-288 18.5 cm, 7 1/4" 28 x 27 mm / 45 x 27 mm

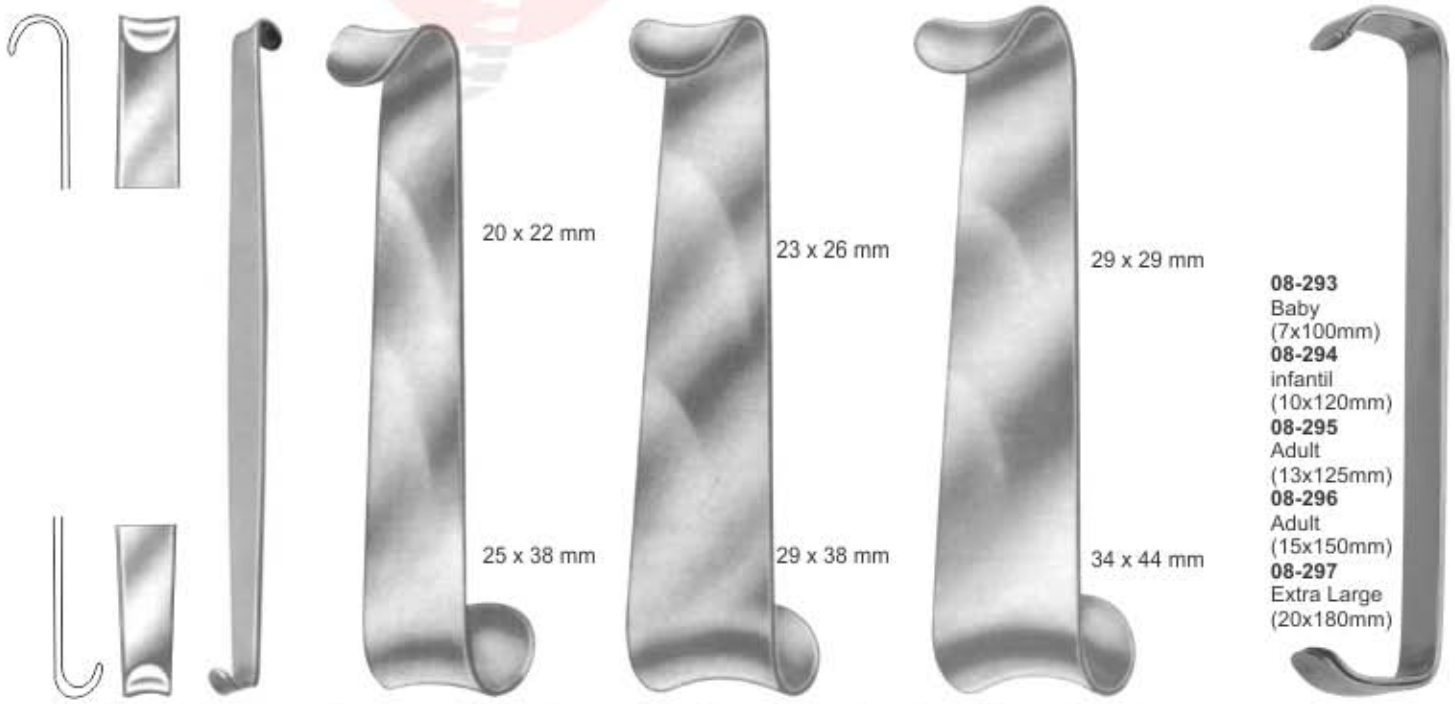

Mini-Roux Retractor

08-289 14 cm, 5 1/2"

Roux-Magnus Retractor

08-290 15 cm, 6" 20 x 22 mm / 25 x 38 mm

Roux-Magnus Retractor

08-291 16 cm, 6 1/4" 23 x 26 mm / 29 x 38 mm

Roux-Magnus Retractor

08-292 17 cm, 6 3/4" 29 x 29 mm / 34 x 44 mm

Farabeuf Retractor

08-293 Baby (7x100mm)
08-294 infantil (10x120mm)
08-295 Adult (13x125mm)
08-296 Adult (15x150mm)
08-297 Extra Large (20x180mm)

Wundhaken | Ecarteurs
Separadores | Divaricatori



Farabeuf Retractor
Set 2 Pcs.
08-298 13 cm, 5"
30 x 10 / 34 x 13 mm
08-299 13 cm, 5"
26 x 10 / 30 x 13 mm



Farabeuf Retractor
Set 2 Pcs.
08-300 15 cm, 6"
27 x 16 / 30 x 16 mm
08-301 15 cm, 6"
23 x 16 / 26 x 16 mm



Parker Retractor
Set 2 pcs.
08-302 13.5 cm, 5 1/4"
22 x 15 mm / 22 x 15 mm
08-303
18.4 cm 7 1/4"



Parker Retractor
08-304 13.5 cm, 5 1/4"
18 x 15 mm / 19 x 15 mm

MANZIM
SURGICO

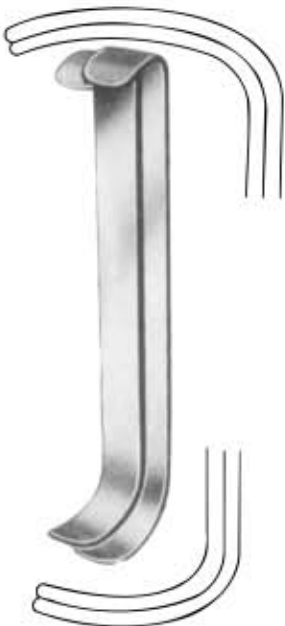

Collin Retractor
Set 2 pcs.
08-305 16.5 cm, 6 1/2"
25 x 12 / 35 x 16 mm
08-306 16.5 cm, 6 1/2"
20 x 12 / 30 x 16 mm



Mayo-Collin Retractor
Set 2 pcs.
08-307 15 cm, 6"
28 x 18 / 25 x 18 mm



Parker-Langenbeck Retractor
Set of 2 Pcs.
08-308 25 x 15 mm fig. 2
08-309 21 x 15 mm fig. 1
08-310 40 x 15 mm fig. 1
08-311 46 x 15 mm fig. 2



Parker-Mott Retractor
08-312
16 cm 6 1/4"
68 x 24 / 74 x 24 mm

08-313
115 x 65 mm



Coryllos Retractor
22.5 cm, 8 3/4"

08-314
115 x 38 mm



08-315
82 x 22 mm



08-316
130 x 38 mm

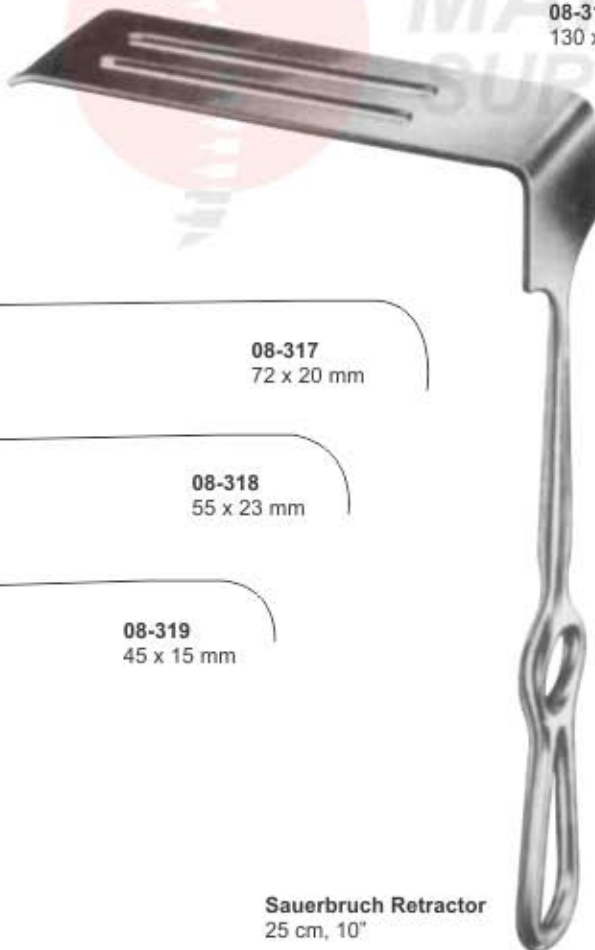

Sauerbruch Retractor
25 cm, 10"

08-317
72 x 20 mm



08-318
55 x 23 mm



08-319
45 x 15 mm

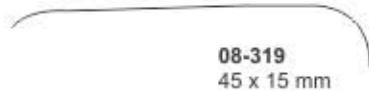

Davidson Retractor
08-320 16 cm, 6 1/4" 75 x 50 mm
08-321 16 cm, 6 1/4" 75 x 90 mm

RETRACTORS

Wundhaken | Ecarteurs
 Separadores | Divaricatori



Bruner Retractor
 25 cm, 10"

- 08-322**
180 x 30 mm
- 08-323**
160 x 30 mm
- 08-324**
140 x 30 mm
- 08-325**
130 x 30 mm
- 08-326**
120 x 25 mm
- 08-327**
100 x 25 mm
- 08-328**
80 x 20 mm

- 180 x 30 mm
- 160 x 30 mm
- 140 x 25 mm
- 120 x 25 mm
- 100 x 20 mm
- 80 x 20 mm

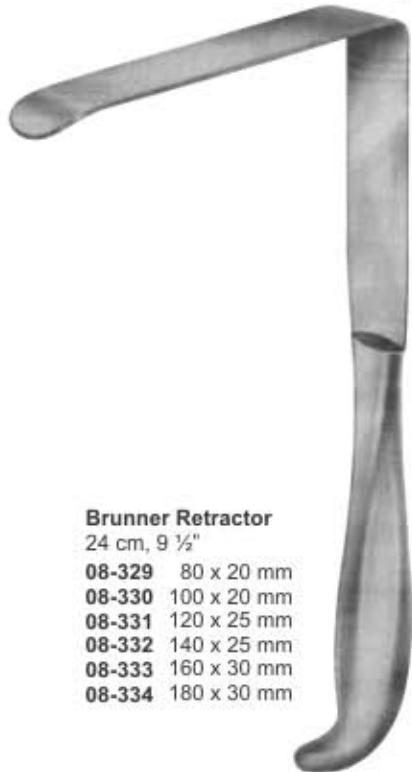

Brunner Retractor
 24 cm, 9 1/2"

- 08-329** 80 x 20 mm
- 08-330** 100 x 20 mm
- 08-331** 120 x 25 mm
- 08-332** 140 x 25 mm
- 08-333** 160 x 30 mm
- 08-334** 180 x 30 mm



Brunner Retractor
 24 cm, 9 1/2"

- 08-335** 80 x 20 mm
- 08-336** 100 x 20 mm
- 08-337** 120 x 25 mm
- 08-338** 140 x 25 mm
- 08-339** 160 x 30 mm
- 08-340** 180 x 30 mm



RETRACTORS

Wundhaken | Ecarteurs
 Separadores | Divaricatori



Mikulicz Retractor
 26 cm, 10 1/4"
08-351
 85 x 50 mm



Kelly Retractor
 27 cm, 10 1/2"
08-352
 190 x 38 mm
08-353
 190 x 57 mm

Mikulicz Retractor
 26 cm, 10 1/4"
08-354
 95 x 35 mm

Mikulicz Retractor
 26 cm, 10 1/4"
08-355
 120 x 50 mm
08-356
 150 x 50 mm

MANZIM
 SURGICO



Cheek-And Lip Retractor
 19 cm, 7 1/2"
08-357
 Movable



Tuffier Retractor
 23 cm, 9"
08-358 55 x 63 mm



Bennet Retractor
08-359
 24cm



Doyen Retractor
 25 cm, 10"
08-360 50 x 85 mm



Fritch Retractor
08-361
 2.75 x 2 mm



Fritch Retractor
 24 cm, 9 1/2"
08-362 35 x 40 mm



Fritsch Retractor
08-363 24 cm, 9 1/2" 30 x 30 mm
08-364 24 cm, 9 1/2" 32 x 40 mm
08-365 24 cm, 9 1/2" 40 x 50 mm
08-366 24 cm, 9 1/2" 40 x 60 mm
08-367 24 cm, 9 1/2" 45 x 75 mm
08-368 24 cm, 9 1/2" 65 x 85 mm



Mikulicz Retractor
08-369
 29 cm 11.5"

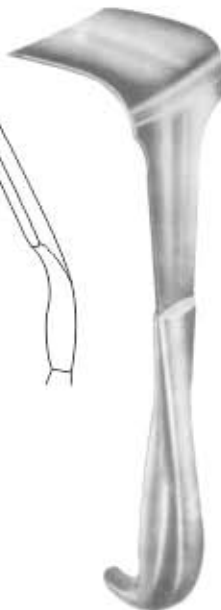

Tuffier Retractor
08-370 23 cm 9"
 64 x 60mm



Harrington Retractor
 32 cm, 12 3/4"
08-371
 127 x 40 mm
08-372
 127 x 62 mm



Harrington Extra Deep Retractor
08-373 30cm 11 3/4"
 Hollow handle, 5.7cm
 width x 20.5cm 8" depth blade



Harrington Splanchnic Retractor
08-374 31.5cm 12 1/2"
 Hollow handle, 3.8cm 1 1/2"
 width x 12.0cm 4 3/4"
 depth blade



Debaquey-Coolley Retractor
08-375 31.0cm 12 1/4"
 Hollow handle, 5.7cm 2 1/4"
 width x 18.4cm 7 1/4"
 depth blade



Meyerding Retractor
08-376
 22.5 cm, 9"
 75 x 25mm

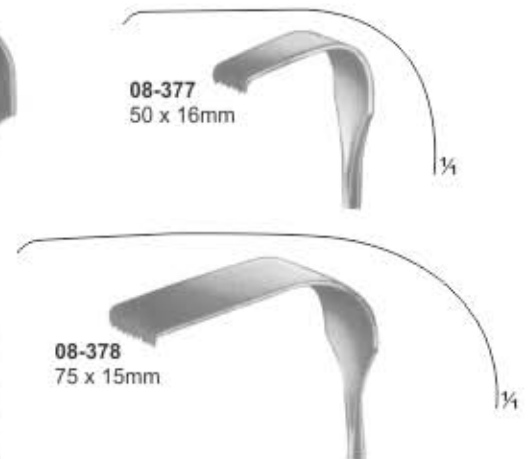

Goelet Retractor
08-379
 19 cm 7 1/2"
 Double Ended

Wundhaken, Venenhäkchen
Separadores, Ganchitos Para venas

Ecarteurs, Ecarteurs sous
Divaricatori, Divaricatori per veni



08-380

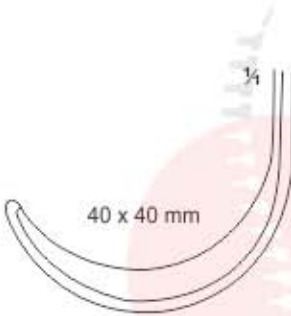
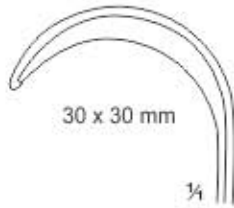

Kaye-Millard Retractor
08-381
8 cm, 3 1/4"



Richardson/Kelly Retractor
08-382
24 cm, 9 1/2"



Ross Retractor
25.5 cm, 10"



Weinberg Vagotomy Retractor (Joe's Hoe)
08-392 20 cm, 8"
Blade 102 x 165 mm wide

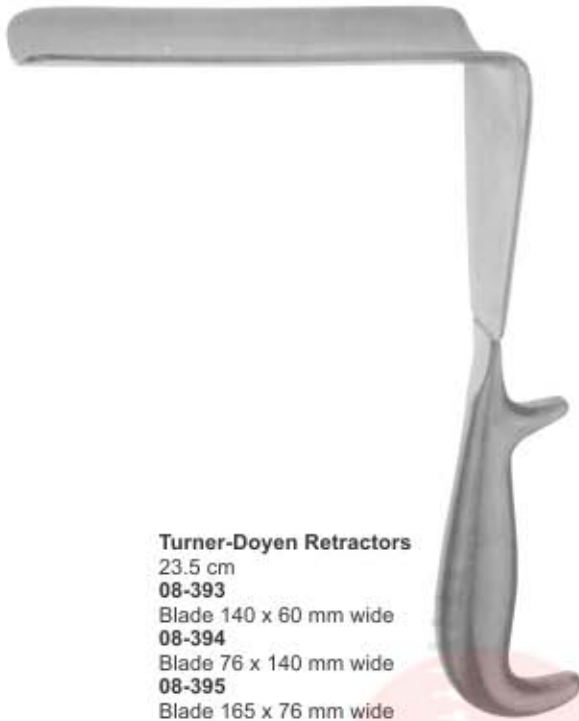

Turner-Doyen Retractors
23.5 cm
08-393
Blade 140 x 60 mm wide
08-394
Blade 76 x 140 mm wide
08-395
Blade 165 x 76 mm wide

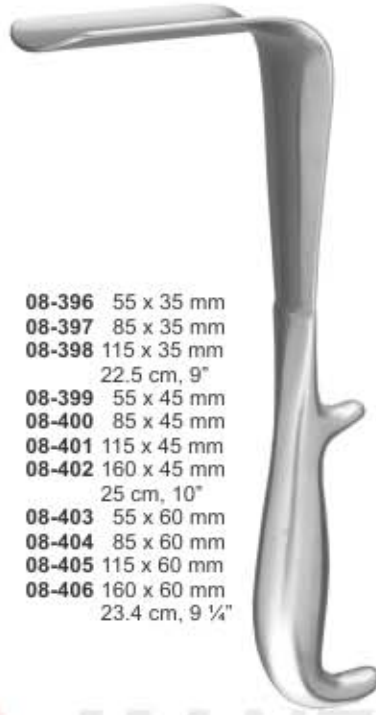

08-396 55 x 35 mm
08-397 85 x 35 mm
08-398 115 x 35 mm
22.5 cm, 9"
08-399 55 x 45 mm
08-400 85 x 45 mm
08-401 115 x 45 mm
08-402 160 x 45 mm
25 cm, 10"
08-403 55 x 60 mm
08-404 85 x 60 mm
08-405 115 x 60 mm
08-406 160 x 60 mm
23.4 cm, 9 1/4"

Doyen Vaginal Retractors



08-407 23cm
Small Blade 70x19mm wide
08-408 25cm
Medium Blade 82x29mm wide
08-409 28cm
Large Blade 22X64mm
08-410 28cm
Large Blade 38X89mm

Sawyer Retractors

MANZIM
SURGICO



08-411 23cm
Blade 60x24mm wide
08-412 25cm
Blade 75x35mm wide

Ferguson-Moon Rectal Retractors



08-413 23cm
Blade 64x24mm wide
08-414 23cm
Blade 76x32mm wide
08-415 25cm
Blade 76x35mm wide

Hill Ferguson Rectal Retractors



08-416 24cm
50x40mm wide
08-417 24cm
65x50mm wide
08-418 25cm
75x65mm wide
08-419 25cm
90x75mm wide

Kelly Retractors



08-420 24cm
Blade 25x20mm wide
08-421 24cm
Blade 36x28mm wide
08-422 24cm
Blade 44x28mm wide
08-423 25cm
Blade 52x22mm wide
08-424 25cm
Blade 70x52mm wide

Richardson Retractors

RETRACTORS

Wundhaken | Ecarteurs
 Separadores | Divaricatori



Kelly Retractor
 08-425 25cm
 55x50mm



Kelly Retractor
 26cm

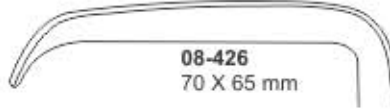

08-426
 70 X 65 mm

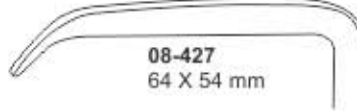

08-427
 64 X 54 mm

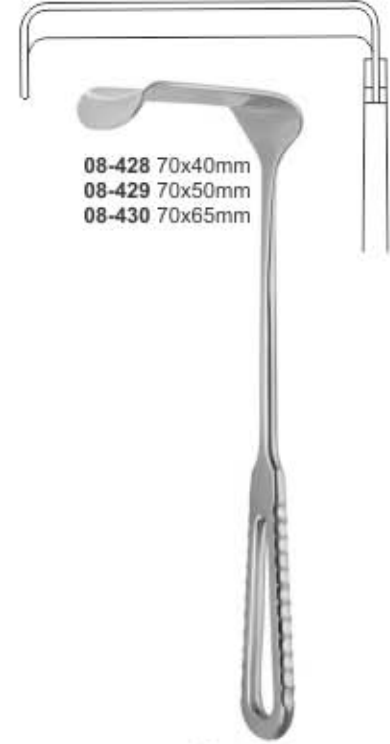

08-428 70x40mm
08-429 70x50mm
08-430 70x65mm

Morris Retractor
 24.5 cm 9 3/4"



Richardson Retractor
 08-431 24cm



Richardson Retractor
 24.0 cm 9.5"



08-432
 23 x 20 mm



08-433
 30 x 29 mm



08-434
 37 x 37 mm

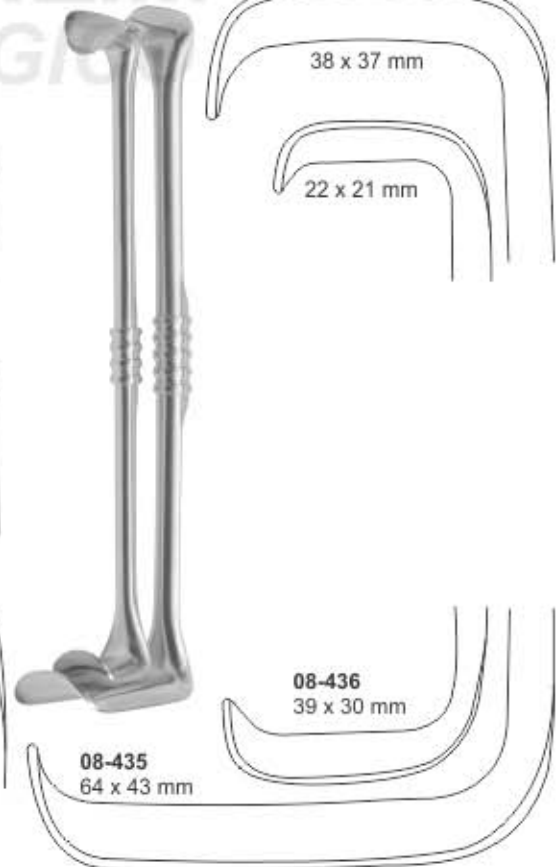

Richardson-Eastman Retractor
 25.0 cm 10", Set of 2 piece

38 x 37 mm

22 x 21 mm

08-436
 39 x 30 mm

08-435
 64 x 43 mm

MANZIM
 SURGICO

RETRACTORS

Wundhaken | Ecarteurs
Separadores | Divaricatori



Malleable Retractor

Item	Description	Tip
08-437	20 cm	12 mm
08-438	20 cm	17 mm
08-439	20 cm	25 mm
08-440	33 cm	25 mm
08-441	33 cm	32 mm
08-442	33 cm	40 mm
08-443	33 cm	50 mm



Ribbon Retractor
08-444
20 cm, 8"
Width 4 cm



Ribbon Retractor
08-445
20 cm, 8"
Width 2.5 cm



Tuffier / Haberer Retractor
08-446 20 cm, 8"
17 x 25 mm
08-447 28 cm,
11" 25 x 30 mm
08-448 30 cm,
11 3/4" 37 x 45 mm
malleable



Bruening Spatuala
08-449
19 cm



Flexival Abdominal Spatuala
08-450 300x20mm
08-451 300x25mm
08-452 300x30mm
08-453 300x35mm
08-454 300x40mm
08-455 300x45mm
08-456 300x50mm



Reverdin Retractor
08-457
28cm
46x60mm



Reverdin Retractor
08-458
29cm



Blood Scoop
08-459
15cm



Heiss Retractor
08-460 10cm
Sharp 4:4
08-461 10cm
Blunt 4:4

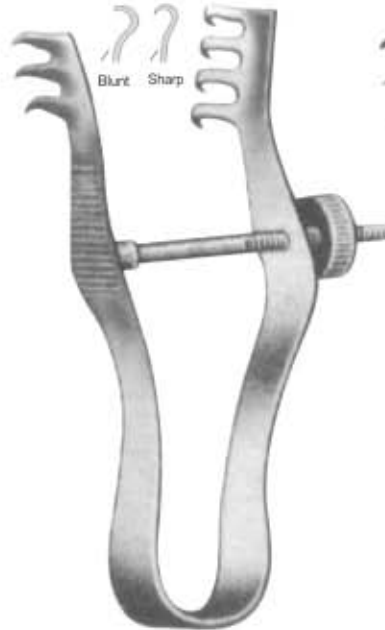

Finsen Retractor
08-462 7 cm, 2 3/4"
3 x 4 teeth, sharp
08-463 7 cm, 2 3/4"
3 x 4 teeth, Blunt



Finsen Retractor
08-464 5 cm, 2"
2 x 3 teeth sharp/blunt
08-465 7 cm, 2 3/4"
2 x 3 teeth sharp/blunt

RETRACTORS

Wundhaken | Ecarteurs
 Separadores | Divaricatori

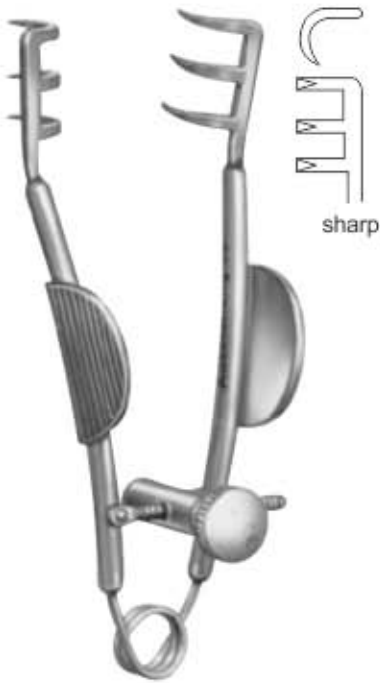

Buckley Retractor
 08-466 6cm



Lancaster Eye Speculum
 08-467 8.3cm
 blades 15 X 5 mm



Castroviejo Eye Speculum
 08-468 9.5cm
 medium blades
 15 X 5 mm O.D.



ALM Retractor
 08-469 7 cm, 2 3/4"
 4 x 4 teeth sharp/blunt
 08-470 10 cm, 4"
 4 x 4 teeth sharp/blunt



Wire Retaining Retractor
 08-471 8.5 cm, 3 1/2" 3 x 3 Prong
 08-472 8.5 cm, 3 1/2" 1 x 1 Prong Sharp



Farr Wire Retractor
 08-473 14 cm 5 1/2"
 prongs 1.9 cm 3/4"



Jansen Retractor
08-474 10 cm, 4"
Sharp 3x3
08-475 10 cm, 4"
Blunt 3x3



Houzel Retractor
08-476 29 cm, 11 1/2"



Mollison Retractor
08-477 15cm, 6"
sharp

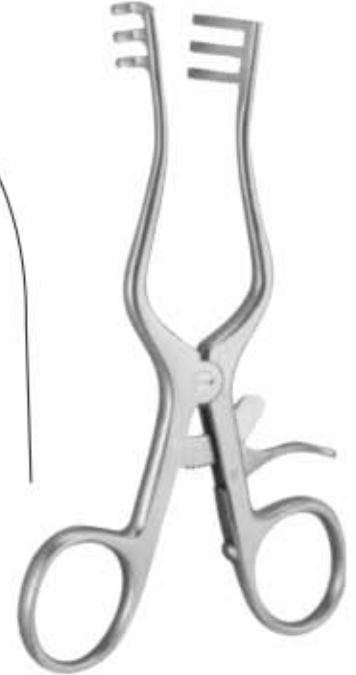

Milligan Retractor
08-478 13 cm, 5"
18.5 mm x 20 mm
Blunt, 3x3



Markham/Meyerding Retractor
08-479 18cm, Blade 55 x 25 mm Left
08-480 18cm, Blade 55 x 25 mm Right



Darling Retractor
08-481 18 cm, 7"
40 x 76/25 x 54 mm
08-482 18 cm, 7"
25 x 64/40 x 76 mm
Laminectomy Retractors
1 blade toothed



Debakey Gelpi Retractor
08-483 13.5cm 5 3/8"
Spread 3 1/8" 8cm, Sharp,

Wundhaken | Ecarteurs
 Separadores | Divaricatori



- 08-484 9cm
- 6 mm Sharp
- 08-485 11cm
- 10 mm Sharp
- 08-486 14cm
- 10 mm Sharp
- 08-487 16cm
- 10 mm Sharp
- 08-488 19cm
- 10 mm Sharp

Gelpi-Loktite Retractor



100 mm

Gelpi-Perineal Retractor
 08-489 17.8cm
 ball stops on sharp tenaculum
 prongs, arm length 12cm



Gelpi-Loktite Retractor
 08-490 9 cm, 6mm Sharp Cross Over
 08-491 11 cm, 10mm Sharp Cross Over
 08-492 14 cm, 10mm Sharp Cross Over
 08-493 16 cm, 10mm Sharp Cross Over
 08-494 19 cm, 10mm Sharp Cross Over



Seletz-Gelpi Retractor
 08-495 17.8cm, 7"
 modified with long
 curve in shanks



Schuhknecht Retractor
 08-496 Sharp
 08-497 Blunt
 14 cm, 5 1/2"



Wullstein Retractor
 08-498 08-501 10.5 cm, 4"
 08-499 08-502 13.0 cm, 5"
 08-500 08-503 16.0 cm, 6 1/4"
 Sharp Blunt



Travers Retractor
 08-504
 21 cm, 8 1/4" Blunt



Righby Retractor
08-505 35 x 20 mm
08-506 60 x 20 mm
08-507 65 x 15 mm
18 cm, 7"



Weitlaner Retractor
08-508
13.0 cm 5.25"
Sharp

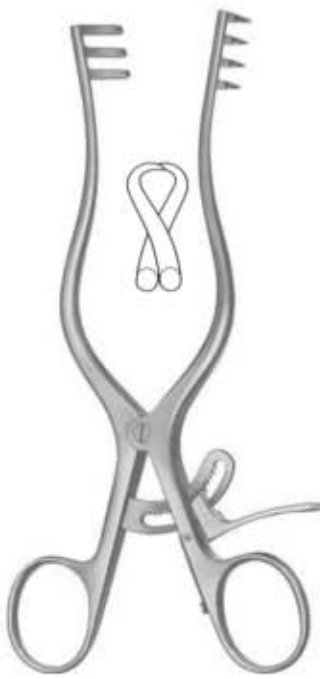

Weitlaner Retractor
08-509
16.5 cm 6.5"
Sharp



Plester Retractor
08-510
11.0 cm 4.25"
Blunt

MANZIM
SURGICO



Perkins Retractor
08-511 13cm



Weitlaner Retractor
08-512 11 cm
Sharp

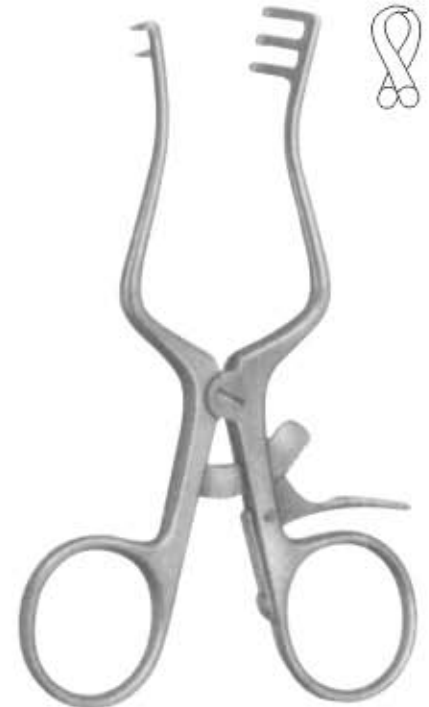

Weitlaner Retractor
08-513 11 cm
Semi-Sharp

Wundhaken | Ecarteurs
 Separadores | Divaricatori

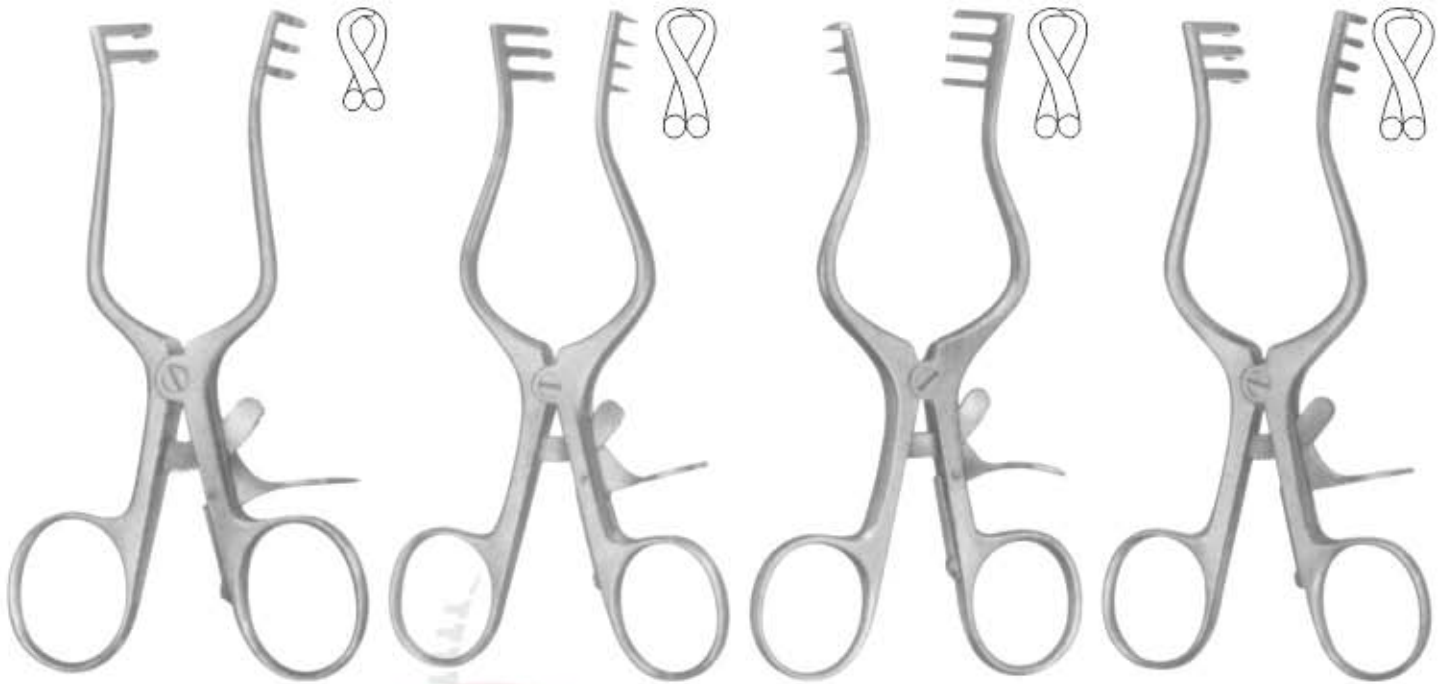

Weitlaner Retractor
08-514 11cm
 Blunt

Weitlaner Retractor
08-515 13cm
 Sharp

Weitlaner Retractor
08-516 13cm
 Semi-Sharp

Weitlaner Retractor
08-517 13cm
 Blunt

MANZIM
 SURGICO



Kolbel Soft Tissue Retractor
08-518 18.0cm 7"
 Angled, 2 x 2 Pronged

Meyerding Retractor
08-519 16.5cm 6 1/2"
08-520 24.1cm 9 1/2" Large Blade
 8.9 cm 3 1/2" X 5.1 cm 2"
08-521 24.1 cm 9 1/2" Small Blade
 5.1 cm 2" X 1.6 cm 5/8"

D'Errico-Adson Retractor
08-522 19.0cm 7 3/8"
 4 X 4-pronged,
 2.0cm 3/4" depth blade
 Sharp

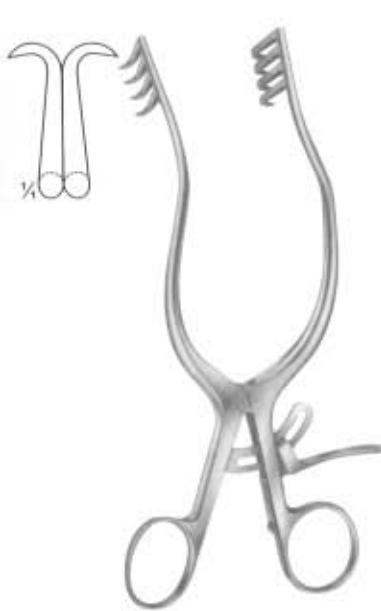

Anderson-Adson Retractor
08-523 19.0 cm 7 1/2"
Sharp

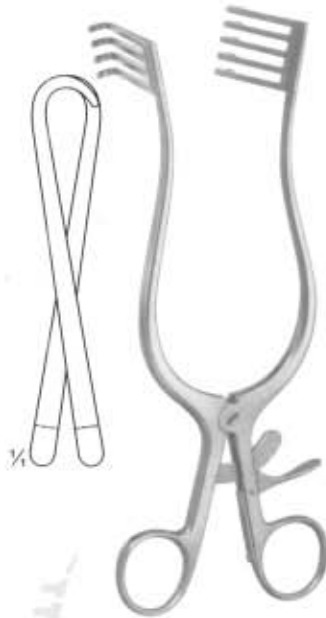

Norfolk & Norwich Retractor
08-524 22.0 cm 8 3/4"
Blunt



Adson Retractor
08-525
19.1 cm 7-1/2" sharp,
4 X 4 teeth straight Arms



Adson Retractor
08-526 26.5 cm 10 1/4"
Sharp



Beckman-Weitlaner Retractor
08-527 16.5cm 6 1/2"
3 x 4 Sharp prongs



Beckman-Weitlaner Retractor
08-528 16.5cm 6 1/2"
3 x 4 Blunt prongs



Cone Retractor

08-529 31 cm, 12"
3x4 Blunt prongs,
13 mm x 14.5 mm
08-530 16.5 cm, 6 1/2"
17 mm x 19 mm
3x4 Sharp prongs,
08-531 16.5 cm, 6 1/2"
17 mm x 19 mm
3x4 Blunt prongs,
08-532 20 cm, 8"
21 mm x 210 mm
3x4 Blunt prongs,

Wundhaken | Ecarteurs
 Separadores | Divaricatori



Beckman Retractor
08-533 31.7cm 12 1/2"
 Spread 3.5cm 5 3/8" 4 x 4
 Sharp prongs, Arm length
 8.5cm 3 3/8"



Beckman Retractor
08-534 31.1cm 12 1/4"
 4 x 4 Sharp prongs 27mm,
 Side Blade 1.7cm 5/8" deep,



Beckman Retractor
08-535 31.1cm 12 1/4"
 4 x 4 Blunt prongs 27mm,
 Side Blade 1.7cm 5/8" deep,



Joll (Friedman)
08-536 15.5 cm, 6 1/2"
 Thyroid- and Vaginal Retractor



Jackson Burrows Retractor
08-537 18.5cm
 Blunt



Gelpi Vaginal Retractor
08-538 13.5cm



Gelpi Skin & Vaginal Retractor
08-539 17.5cm



De Bakey Femur Retractor
08-540 14.5cm

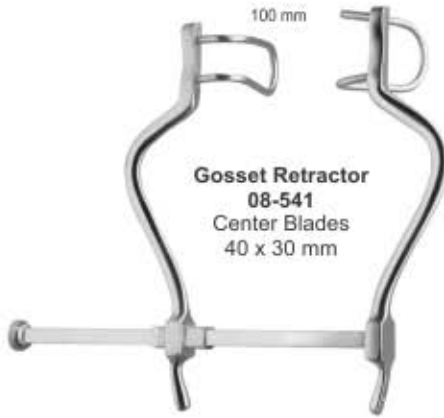

**Gosset Retractor
08-541**
Center Blades
40 x 30 mm

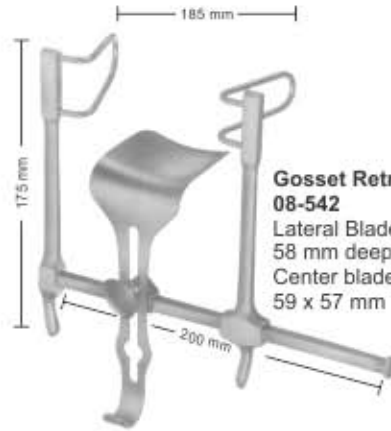

**Gosset Retractor
08-542**
Lateral Blades
58 mm deep
Center blade
59 x 57 mm

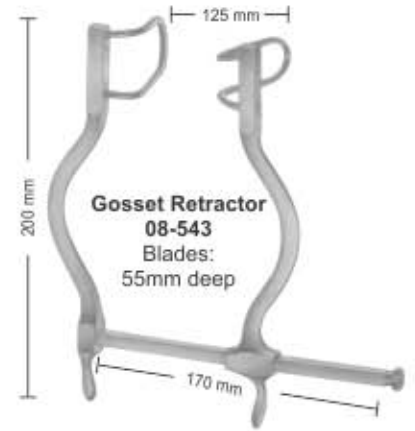

**Gosset Retractor
08-543**
Blades:
55mm deep

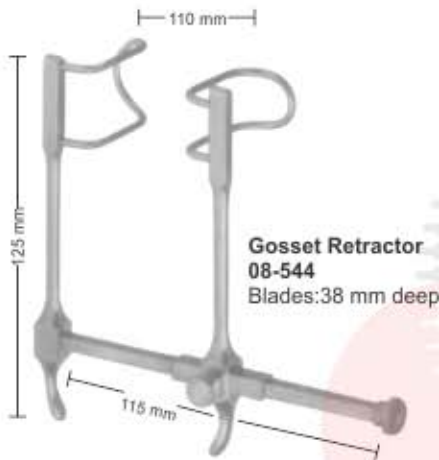

**Gosset Retractor
08-544**
Blades:38 mm deep

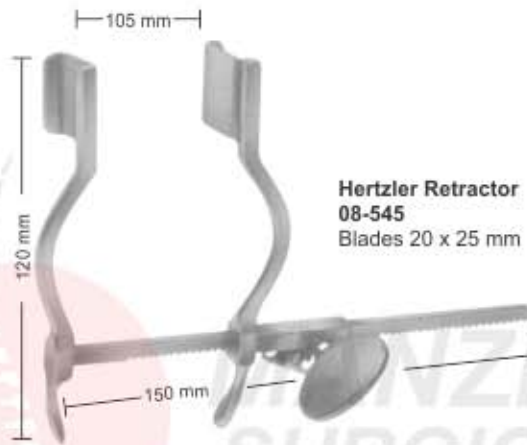

**Hertzler Retractor
08-545**
Blades 20 x 25 mm



**Balfour-Baby
Retractor
08-546**
Lateral Blades
27 mm deep
Center blade
21 x 24 mm

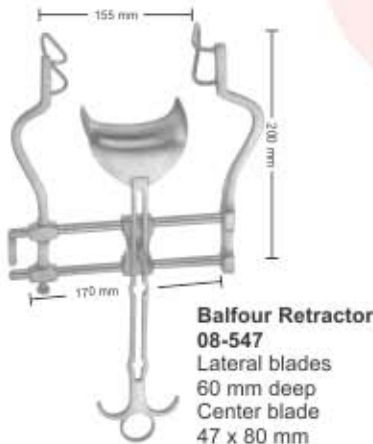

**Balfour Retractor
08-547**
Lateral blades
60 mm deep
Center blade
47 x 80 mm



**Balfour Retractor
08-548**
Lateral blades
105 mm deep
Center blade
107 x 59 mm



08-549
Center blade only
54 x 80 mm

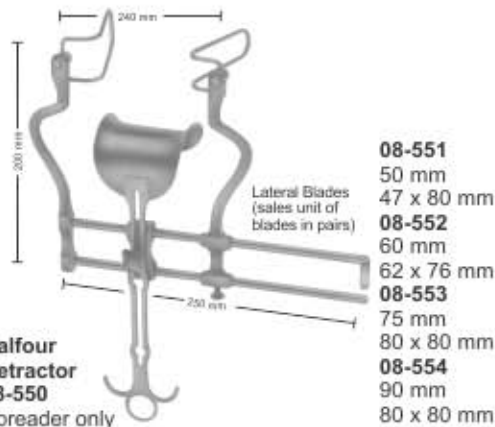

**Balfour
Retractor
08-550**
Spreader only

- 08-551**
50 mm
47 x 80 mm
08-552
60 mm
62 x 76 mm
08-553
75 mm
80 x 80 mm
08-554
90 mm
80 x 80 mm
- Lateral Blades
(sales unit of
blades in pairs)



- Finochietto Retractors**
08-555 18x22 8cm
08-556 25x40 13cm
08-557 38x45 16cm
08-558 40x45 18cm

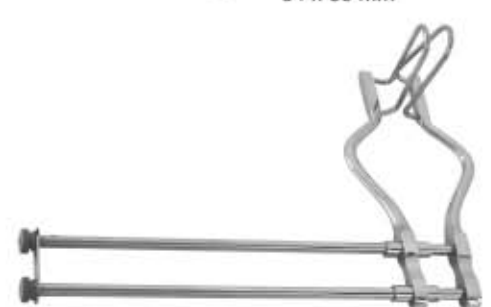

- Gosset Abdominal Retractors**
08-559 12cm
08-560 16cm
08-561 24cm
08-562 30cm

Wundhaken | Ecarteurs
Separadores | Divaricatori



08-565
Single Retractor Blade
110 x 70 mm



08-566
Set of 2 Retractor Blade
80 x 45 mm



**ABRE BOCA MC IVOR C/3
LAMINAS S/ SUCCAO
ABRE BOCA
08-567**

O'Sullivan/O'Connor Retractor
08-563 (Set includes frame & 3 blades)
08-564 Frame Only (not pictured)



08-568
Center Blade
45 x 80 mm
70 x 85 mm

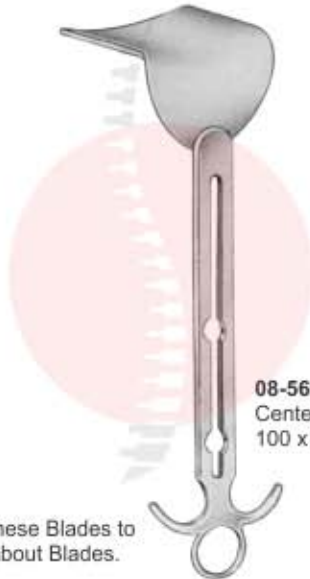

08-569
Center Blade
100 x 60 mm

Sizes of These Blades to Same as about Blades.



Collin Retractor
08-570 Complete
08-571 Spreader only
08-572 Blades 55 x 25 mm
08-573 Blades 80 x 25 mm
08-574 Center Blade
115 x 45 mm

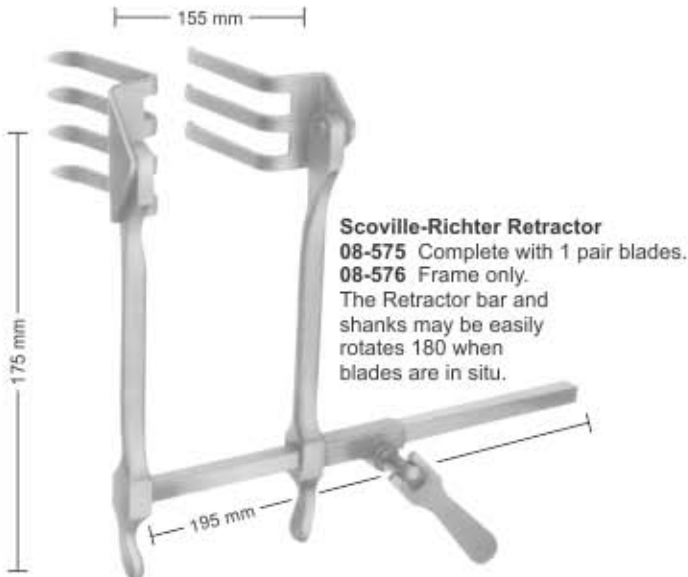

Scoville-Richter Retractor
08-575 Complete with 1 pair blades.
08-576 Frame only.
The Retractor bar and shanks may be easily rotates 180 when blades are in situ.



08-577
62 x 52 mm

08-578
62 x 37 mm

08-579
47 x 51 mm



08-580
30 x 40 mm



08-581
37 x 62 mm

RETRACTORS

Wundhaken | Ecarteurs
Separadores | Divaricatori

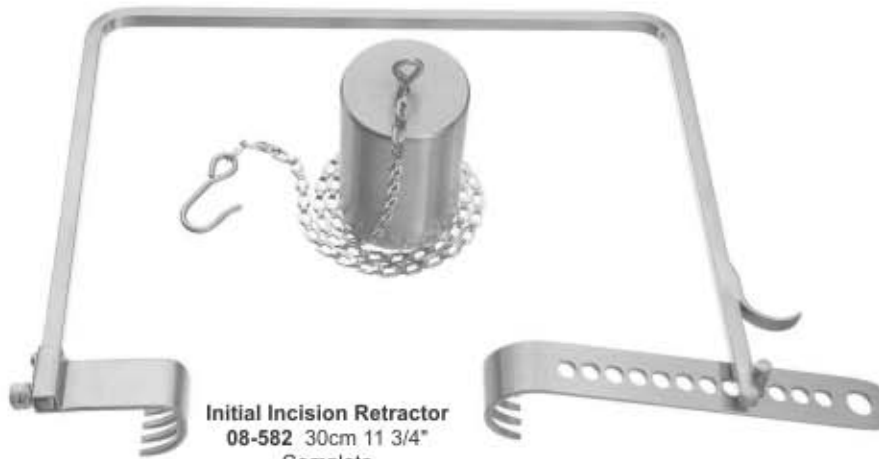

Initial Incision Retractor
08-582 30cm 11 3/4"
Complete



Legueu Retractor
08-583
17 cm, 6 3/4"



Collin Retractor
08-584 20 cm, 8"
complete with 2 lateral
blades and central blade



Doyen Retractor
08-585 48 mm x 90 mm
08-586 48 mm x 105 mm
08-587 48 mm x 120 mm
08-588 48 mm x 135 mm
28 cm, 11"



Rochard Retractor
08-589 48 mm x 90 mm
08-590 48 mm x 105 mm
08-591 48 mm x 120 mm
08-592 48 mm x 135 mm
08-593 48 mm x 155 mm
31 cm, 12"

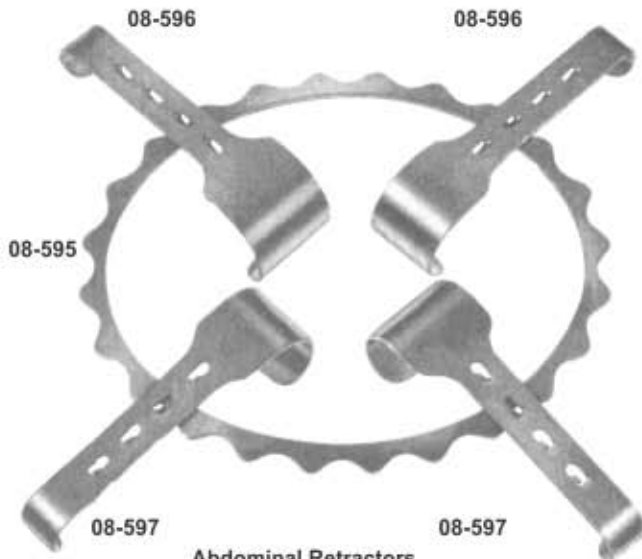

Abdominal Retractors
for new-born and children

Denis-Browne Retractor
08-594 Complete with 4 blades

- 08-595 Frame 190 x 160 mm
- 08-596 2 blades only 40 x 30 mm
- 08-597 2 blades only 40 x 40 mm

08-598
Blades only 20 x 30 mm

08-599
Blades only 20 x 40 mm



Wundhaken | Ecarteurs
 Separadores | Divaricatori

Abdominal Retractors

well suitable for gynaecologists

Semm Abdominal Retractors

consisting of:

- 08-600** 1 frame 225 x 220 mm
- 08-601** 2 blade 46 x 64 mm
- 08-602** 1 blade 53 x 54 mm
(for bladder)
- 08-603** 1 blade 82 x 97 mm
(for intestine)
- 08-604** 1 blade 98 x 51 mm
(for intestine)
- 08-605** 1 blade, narrow
107 x 36 mm

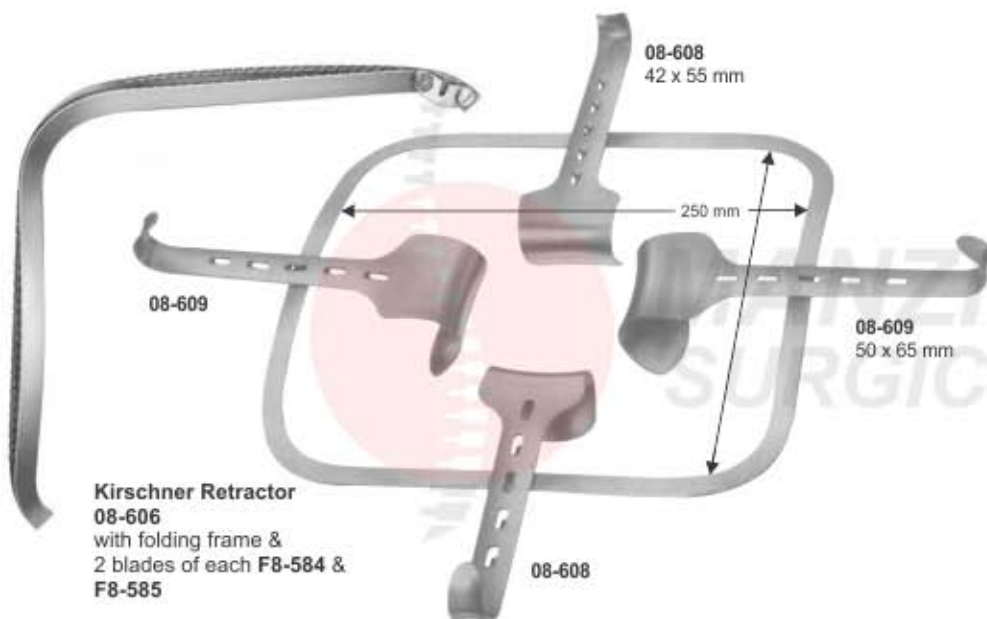
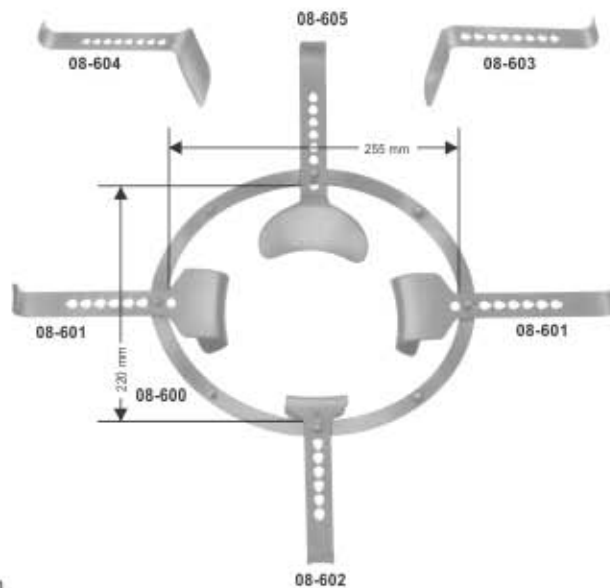

Kirschner Retractor
08-606
 with folding frame &
 2 blades of each **F8-584** &
F8-585

Kirschner Retractor

08-607
 with vaulted fixed frame &
 2 blades of each **08-608** &
08-609

08-610
 300 x 380 mm
 Frame only, over-sized

08-611
 320 x 300 mm
 Frame only

Additional valves for corpulent persons



Kirschner Retractor
08-612
 64 x 80 mm



Kirschner-Balfour
Retractor
08-613
 80 x 82 mm



Kirschner Retractor
08-614 90 x 69 mm
08-615 92 x 95 mm
08-616 78 x 58 mm



Kirschner Retractor
08-617 108 x 42 mm
08-618 91 x 55 mm
08-619 121 x 55 mm

PLASTIC SURGERY INSTRUMENTS





09-001
Grossmann Areola Marker,
40mm,44mm, 48mm, 52mm



Freeman Areola Marker,
2 Sizes,
09-002 34mm / 36mm
09-003 38mm / 42mm
09-004 42mm / 45mm
09-005 45mm / 50mm



Freeman Areola Marker,
09-006 34mm
09-007 36mm
09-008 38mm
09-009 42mm
09-010 45mm
09-011 50mm



Freeman Areola Marker,
09-012 38 mm
09-013 42 mm
09-014 50 mm
09-015 45 mm
09-016 34 mm
09-017 36 mm



Solz Areola Marker, Blunt,
09-018 36mm Diameter
09-019 40mm Diameter
09-020 42mm Diameter
09-021 45mm Diameter



Solz Atraumatic
Breast Dissector,
09-022 34cm
09-023 37cm



Solz Breast Hook
Dissector,
09-024 36cm



Agris Dingman Breast
Dissector, Set of 2,
Left And Right,
09-025 36cm



Maccollum Dingman
Submammary
Dissector,
09-026 30cm



Maccollum Dingman
Breast Dissector,
09-027 31.5cm
09-028 41cm



Reynolds Transauxillary
Breast
Dissector, Fenestrated,
09-029 33cm
09-030 40cm



Breast Dissector,
Angulated Blade,
09-031 33cm
09-032 42cm



Breast Dissector,
Spatulated Blade,
09-033 33cm
09-034 42cm



Breast Dissector,
Oval Spatulated
Blade,
09-035 33cm
09-036 42cm



Spatula Breast
Retractor
Dissector,
Serrated,
09-037 1/2",
Semi Malleable



Trocar Breast Tube,
09-038 356mm
Total Length,
Large, 17.3mm Id,
19mm Od
09-038 343mm
Small, 14mm Id, 16mm Od



Penn Breast
Dissector,
Straight,
09-039
25mm Width
324mm Length



Maccollum
Dingman
Breast
Dissector
09-040
38mm Width,
432mm Length



Mcinnis
Polycurette
Breast
Instrument
09-041
30mm Width
09-042
318mm Length



Iconoclast,
09-043 Large
292mm Length
146mm Blade
09-044 Small
222mm Length,
83mm) Blade



Silverstein Breast
Dissector,
09-045
356mm Length



Breast Elevator For
Mammary Plasty
09-046



Temporal T
Dissector
09-047
23.5cm
12mm Tip,
Straight



Flap Dissector
09-048 23.5cm
5mm Tip, Straight



Midface Facial
Dissector
09-049 24cm
Multiple Curves,
12mm Wide Tip



Transoral
Dissector
09-050
23.5cm
Curved Tip



Frontotemporal Dissector
09-051 22.5cm
 5mm Tip, Slightly Curved
09-052 23cm
 7mm Tip, Slightly Curved
09-053 23cm
 10mm Tip, Slightly Curved



Scalp Elevator 24cm
09-054 12.5mm Tip, Slightly Curved
09-055 15mm Tip, Slightly Curved
09-056 7mm Tip, Straight
09-057 12.5mm Tip, S Shaped
09-058 12.5mm Tip, Slightly Curved
09-059 7mm Tip, Curved Tip
09-060 7mm Tip, Strongly Curved
09-061 7mm Tip, Slightly Curved



Orbital Rim Dissector
09-062 22.5cm
 Slightly Curved



Frontoglabellar Dissector
09-063 26.5cm
 7mm Tip, S Shaped



Arcus Marginalis Dissector
09-064 24cm
 10mm Tip, S Shaped



Periosteal Elevator
09-065 25cm
 S Shaped



Periosteal Spreader
09-066 24cm
 8mm Tip, S Shaped



Periosteal Spreader
09-067 24cm
 10mm Wide Blade, S Shaped



Zygomatic Arch Elevator
09-068 20.5cm
 Straight Blade, 5mm



Scalp Elevator With Suction
09-069 24cm
 7mm Wide Tip, Slightly Curved



Scalp Elevator With Suction
09-070 26cm
 8.5mm Wide Tip, Curved Tip



Langenbeck Bone Elevator
09-071 20cm, 7mm, Blunt
09-072 20cm, 10mm, Blunt

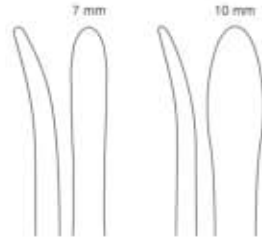

Suction Elevator With Guide
09-073 21cm, 4mm



Cottle Periosteal Elevator,
09-074 20cm,
 2/4mm, Double Ended, Fine
09-075 23cm,
 3/4mm, Double Ended





Masing Septum Elevator,
09-076 22cm
5mm, Double Ended



Nagata Auricular Septum Elevator,
09-077 16cm, Blunt
09-078 17cm, Blunt



Halle Septum Elevator,
Narrow, 3 mm
Width
09-079 178mm
Length



Freer Septum Elevator,
Double Ended, Sharp /
Blunt, Wide, 6.5mm Width,
09-080 197mm Length



Hajek Ballenger Septum Elevator, Double Ended,
8.5mm Width
09-081 191mm Length



Freer Septum Elevator,
Curved, Double Ended,
5mm Width
09-082 191mm
Length



Killian Septum Elevator,
Double Ended, 4 mm
With 3.4 Mm Taper, And
4.3 Mm With 3mm Taper,
09-083 184mm Length



Killian Septum Elevator,
Double Ended
09-084 229mm Length,
6mm With 4.5 Mm Taper
And 4.3mm With 3mm Taper



Howarth Septum Elevator,
Double Ended, 5mm Width
09-085 216mm Length



Gruber Combination
Knife Handle
/ Perichondrium Elevator #7
09-086 165mm) Length,
10/15c Blade Size



Obwegeser Rib Raspatory,
09-087 30cm, Left
09-088 30cm, Right



Joseph Masing
Septum Raspatory,
09-089 22cm, 4mm,
Sharp

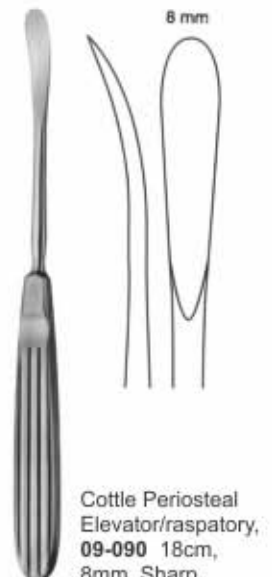

Cottle Periosteal
Elevator/raspatory,
09-090 18cm,
8mm, Sharp



Marx Breast Retractor,
09-091 27cm, 125 X 30mm
09-092 27cm, 140 X 30mm



Ferreira Style Retractor, With Fiber Optic Light Guide

With Smoke Tube	Without Smoke Tube
09-093 70 X 16 mm	09-108 70 X 16 mm
09-094 80 X 16 mm	09-109 80 X 16 mm
09-095 90 X 27 mm	09-110 90 X 27 mm
09-096 110 X 25 mm	09-111 110 X 25 mm
09-097 120 X 25 mm	09-112 120 X 25 mm
09-098 130 X 16 mm	09-113 130 X 16 mm
09-099 130 X 25 mm	09-114 130 X 25 mm
09-100 150 X 25 mm	09-115 150 X 25 mm
09-101 150 X 30 mm	09-116 150 X 30 mm
09-102 150 X 36 mm	09-117 150 X 36 mm
09-103 180 X 16 mm	09-118 180 X 16 mm
09-104 180 X 25 mm	09-119 180 X 25 mm
09-105 190 X 25 mm	09-120 190 X 25 mm
09-106 190 X 36 mm	09-121 190 X 36 mm
09-107 220 X 27 mm	09-122 220 X 27 mm

Breast Spatula With Handle
09-123 31.5cm, 25mmX18cm
 Blade, Serrated Tip, Semi Malleable

MANZIM
SURGICO



Wieder Breast And Facial Retractor /
 Tongue Depressor, Serrated,
09-124 14cm, 28mm, With Fiber Optic Light Guide
09-125 14cm, 38mm, With Fiber Optic Light Guide
09-126 15cm, 45mm, With Fiber Optic Light Guide



Wieder Breast And Facial Retractor
 / Tongue Depressor, Serrated,
09-127 14cm, 28mm
09-128 14cm, 38mm
09-129 15cm, 45mm



Breast Retractor, Double Ended,
09-130 31cm,
 Blades 22mm X 55mm and 38mm x 70mm
09-131 24cm,
 Blades 22mm x 55mm and 38mm x 70mm



Biggs Mammoplasty
Retractors,
09-132 30mm
09-133 50mm
With Fiber Optic Light Guide
09-134 30mm,
09-135 50mm,
With Fiber Optic Light Guide And Suction



Biggs Mammoplasty Retractor,
09-136
50mm Width, Standard,
20cm Length



09-137 Biggs Mammoplasty Retractor,
With Fiber Optic Light Guide 5.0cm
Blade Width, 20cm Length



09-138 Biggs Mammoplasty Retractor,
3cm Blade Width, Narrow,
171mm Length



09-139 Biggs Mammoplasty Retractor,
With Fiber Optic Light Guide,
Narrow, 3.0cm Blade Width,
15cm Length



09-140 Ferreira Breast Augmentation Retractor,
25x171cm Blade, 130mm Handle Length

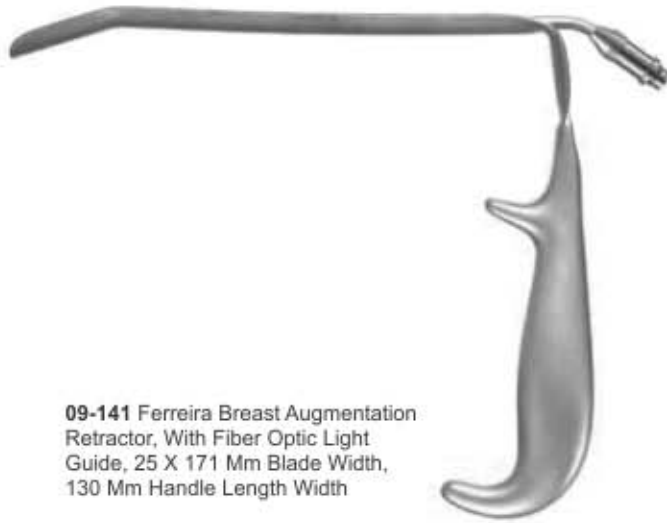

09-141 Ferreira Breast Augmentation Retractor, With Fiber Optic Light Guide, 25 X 171 Mm Blade Width, 130 Mm Handle Length Width

Tebbetts Retractor With Fiber Optic Light Guide, 18.5cm

With Irrigation Tube

- 09-142 70 X 16 mm
- 09-143 80 X 16 mm
- 09-144 90 X 27 mm
- 09-145 110 X 25 mm
- 09-146 120 X 25 mm
- 09-147 130 X 16 mm
- 09-148 130 X 25 mm
- 09-149 150 X 25 mm
- 09-150 150 X 30 mm
- 09-151 150 X 36 mm
- 09-152 180 X 16 mm
- 09-153 180 X 25 mm
- 09-154 190 X 25 mm
- 09-155 190 X 36 mm
- 09-156 220 X 27 mm

Without Irrigation Tube

- 09-157 70 x 16 mm
- 09-158 80 x 16 mm
- 09-159 90 x 27 mm
- 09-160 110 x 25 mm
- 09-161 120 x 25 mm
- 09-162 130 x 16 mm
- 09-163 130 x 25 mm
- 09-164 150 x 25 mm
- 09-165 150 x 30 mm
- 09-166 150 x 36 mm
- 09-167 180 x 16 mm
- 09-168 180 x 25 mm
- 09-169 190 x 25 mm
- 09-170 190 x 36 mm
- 09-171 220 x 27 mm



**MANZIM
SURGICO**

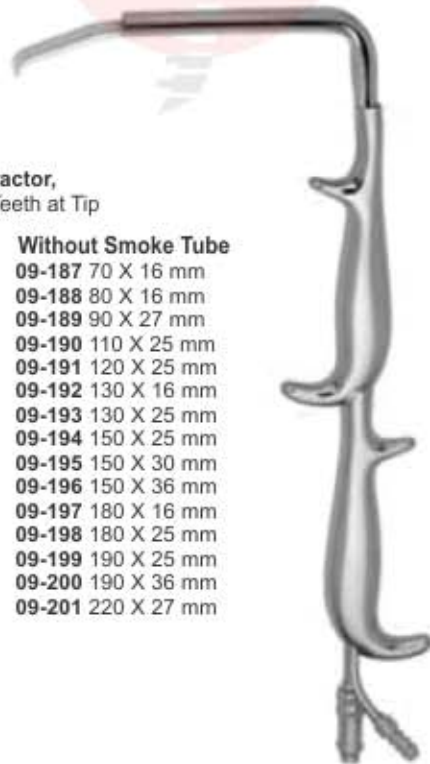

Tebbetts Fiber Optic retractor,
With Double Handle and Teeth at Tip

With Smoke Tube

- 09-172 70 x 16 mm
- 09-173 80 x 16 mm
- 09-174 90 x 27 mm
- 09-175 110 x 25 mm
- 09-176 120 x 25 mm
- 09-177 130 x 16 mm
- 09-178 130 x 25 mm
- 09-179 150 x 25 mm
- 09-180 150 x 30 mm
- 09-181 150 x 36 mm
- 09-182 180 x 16 mm
- 09-183 180 x 25 mm
- 09-184 190 x 25 mm
- 09-185 190 x 36 mm
- 09-186 220 x 27 mm

Without Smoke Tube

- 09-187 70 X 16 mm
- 09-188 80 X 16 mm
- 09-189 90 X 27 mm
- 09-190 110 X 25 mm
- 09-191 120 X 25 mm
- 09-192 130 X 16 mm
- 09-193 130 X 25 mm
- 09-194 150 X 25 mm
- 09-195 150 X 30 mm
- 09-196 150 X 36 mm
- 09-197 180 X 16 mm
- 09-198 180 X 25 mm
- 09-199 190 X 25 mm
- 09-200 190 X 36 mm
- 09-201 220 X 27 mm

Tebbetts Breast Augmentation Fiber Optic Retractor,
With Double Handle And Smooth End

With Smoke Tube

- 09-202 70x16mm
- 09-203 80x16mm
- 09-204 90x27mm
- 09-205 110x25mm
- 09-206 120x25mm
- 09-207 130x16mm
- 09-208 130x25mm
- 09-209 150x25mm
- 09-210 150x30mm
- 09-211 150x36mm
- 09-212 180x16mm
- 09-213 180x25mm
- 09-214 190x25mm
- 09-215 190x36mm
- 09-216 220x27mm

Without Smoke Tube

- 09-217 70x16mm
- 09-218 80x16mm
- 09-219 90x27mm
- 09-220 110x25mm
- 09-221 120x25mm
- 09-222 130x16mm
- 09-223 130x25mm
- 09-224 150x25mm
- 09-225 150x30mm
- 09-226 150x36mm
- 09-227 180x16mm
- 09-228 180x25mm
- 09-229 190x25mm
- 09-230 190x36mm
- 09-231 220x27mm

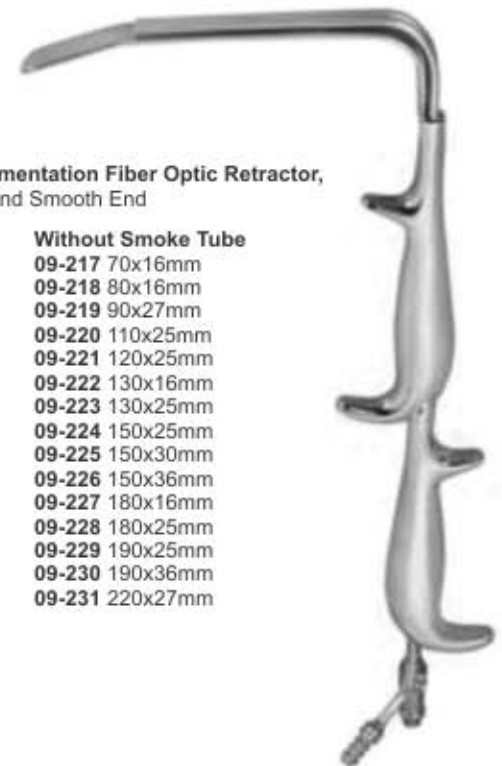



Tebbetts Breast Augmentation Fiber Optic Retractor, Insulated Blade With Smooth End, 18.5 Cm

With Smoke Tube

- 09-232 70x16mm
- 09-233 80x16mm
- 09-234 90x27mm
- 09-235 110x25mm
- 09-236 120x25mm
- 09-237 130x16mm
- 09-238 130x25mm
- 09-239 150x25mm
- 09-240 150x30mm
- 09-241 150x36mm
- 09-242 180x16mm
- 09-243 180x25mm
- 09-244 190x25mm
- 09-245 190x36mm
- 09-246 220x27mm

Without Smoke Tube

- 09-247 70x16mm
- 09-248 80x16mm
- 09-249 90x27mm
- 09-250 110x25mm
- 09-251 120x25mm
- 09-252 130x16mm
- 09-253 130x25mm
- 09-254 150x25mm
- 09-255 150x30mm
- 09-256 150x36mm
- 09-257 180x16mm
- 09-258 180x25mm
- 09-259 190x25mm
- 09-260 190x36mm
- 09-261 220x27mm



Tebbetts Fiber Optic retractor, Insulated Blade With Teeth 18.5cm

With Smoke Tube

- 09-262 70x16mm
- 09-263 80x16mm
- 09-264 90x27mm
- 09-265 110x25mm
- 09-266 120x25mm
- 09-267 130x16mm
- 09-268 130x25mm
- 09-269 150x25mm
- 09-270 150x30mm
- 09-271 150x36mm
- 09-272 180x16mm
- 09-273 180x25mm
- 09-274 190x25mm
- 09-275 190x36mm
- 09-276 220x27mm

Without ISmoke Tube

- 09-277 70x16mm
- 09-278 80x16mm
- 09-279 90x27mm
- 09-280 110x25mm
- 09-281 120x25mm
- 09-282 130x16mm
- 09-283 130x25mm
- 09-284 150x25mm
- 09-285 150x30mm
- 09-286 150x36mm
- 09-287 180x16mm
- 09-288 180x25mm
- 09-289 190x25mm
- 09-290 190x36mm
- 09-291 220x27mm



**MANZIM
SURGICO**



Sculpo Breast Retractors, 180 X 25mm Blade Size, With
 09-292 5mm Endoscopic Scope Sheath
 09-293 10mm Endoscopic Scope Sheath



09-294 Ring Breast Retractor With Fiber Optic Illumination And Irrigation Tube



Aiach Forceps,
09-295 16cm,
5mm Tip



Dingman Cartilage
Abraders,
Set of Two
09-296



Rubin Septal Morselizer
Forceps,
09-297 21cm



Rubin Septal Morselizer
Forceps,
T.c. (tungsten Carbide)
09-298 20cm



Mayo Scissors,
Supercut Plus T.c.
(tungsten Carbide)
09-299 17cm, Curved

MANZIM
SURGICO

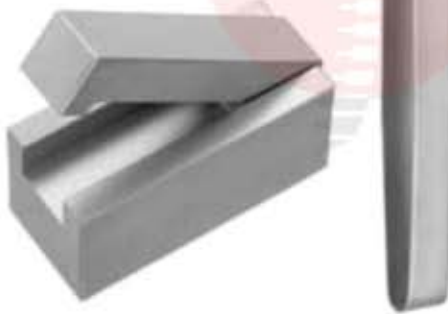

Cottle Cartilage Crusher, With Clamp, For
Taking Out The Prepared Material,
09-300 65x30x30mm



Gubisch Cartilage Crusher
09-301 65x30mm



Cartilage Cutting Block, Teflon,
09-302 85x55x10mm



Bone Mill, With Assembling Wrench
09-303



Aufricht Nasal Retractor,
09-304 18cm
45x7-10mm



Aufricht Nasal Retractor
Double Ended, Blunt,
09-305 13.5cm
282-38x7mm



Aufricht Walter Nasal Retractor
Double Ended, Blunt,
09-306 13.5cm
283-38x7mm



Aufricht Walter Nasal Retractor
Double Ended, Sharp,
09-307 13.5cm
284-42x7mm



Cottle Alar Retractor,
09-308 15cm,
22x13mm



Walter Alar And Nasal Retractor
With Fiber Optic Illumination,
09-309 18.5cm



Gubisch Aufricht
Nasal Retractor,
09-310 17cm,
50x6-12mm

MANZIM
SURGICO



Aufrecht Nasal Retractor
09-311 16cm
 7mm Tip, 45mm
 Blade, With Fiber Optic
 Light Guide
09-312 18cm 10mm



Converse Blade Nasal Retractor,
09-313 20mm X 10mm Wide,
 With Fiber Optic Light Guide
09-314 30mm X 12mm Wide,
09-315 40mm X 12mm Wide,
09-316 50mm X 12mm Wide,



Fomon Nasal Retractor,
09-317 1 Ball End Prong
 16cm
09-318 2 Ball 16cm



Killian Nasal Speculum
 With Fiber
 Optics Illumination
09-319

MANZIM
SURGICO



Joseph Nasal Saw,
09-320 17cm,
 Straight



Joseph Nasal Saw,
09-321 17cm, Left
09-322 17cm, Right

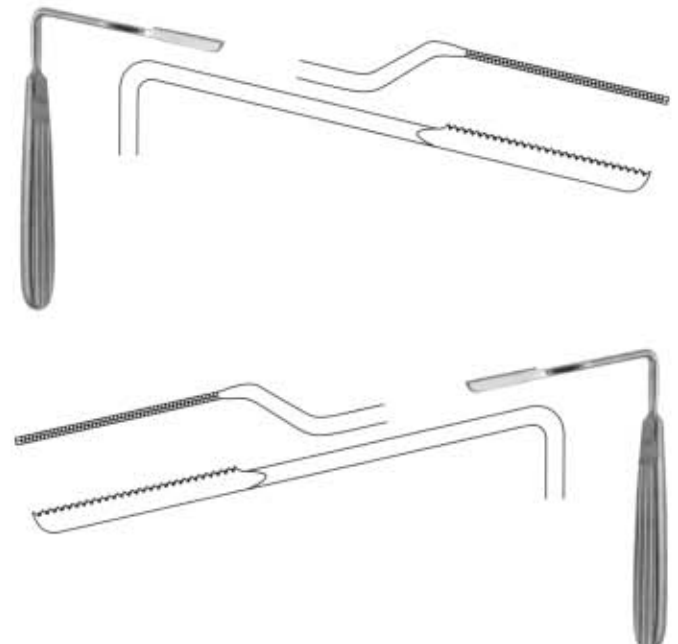

Joseph Nasal Saw,
09-323 Angled To Left
09-324 Angled To Right

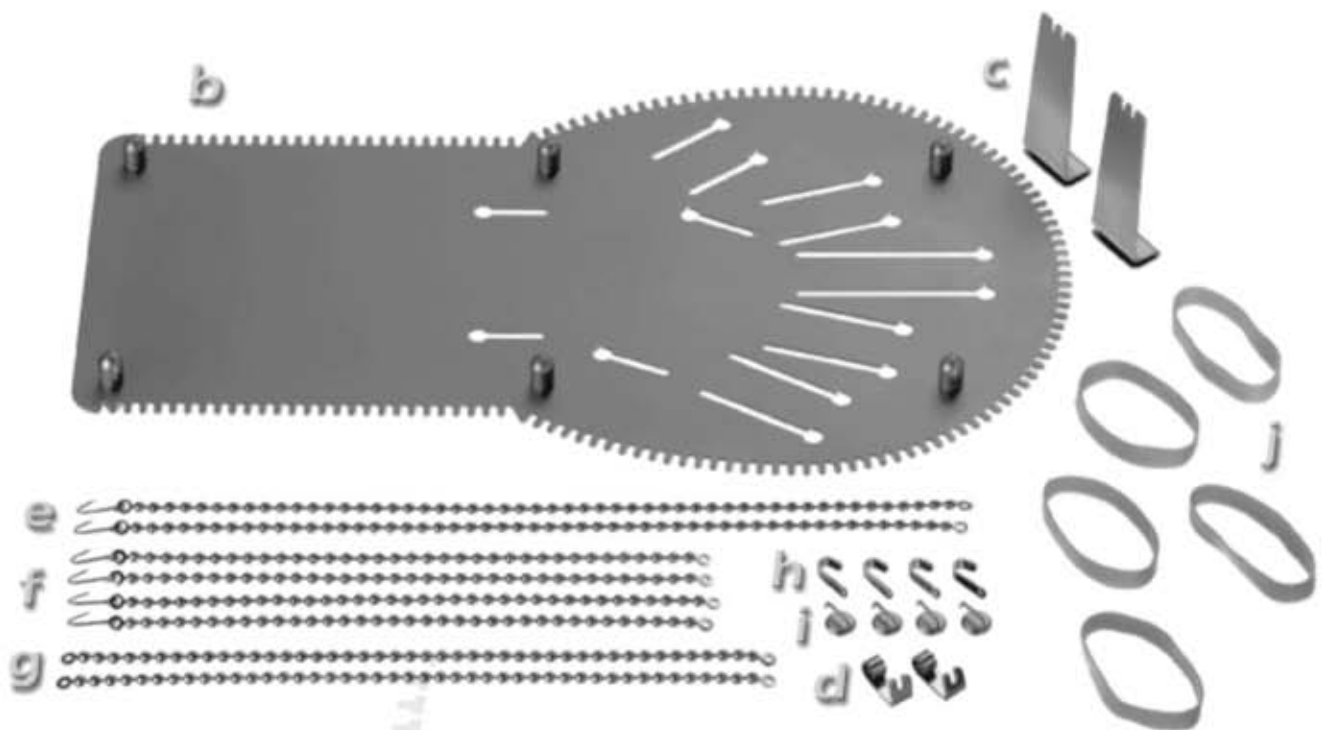

Tuppers Hand Retractor Set
09-325 Medium
09-326 For Infants
09-327 For Adults

MANZIM
SURGICO

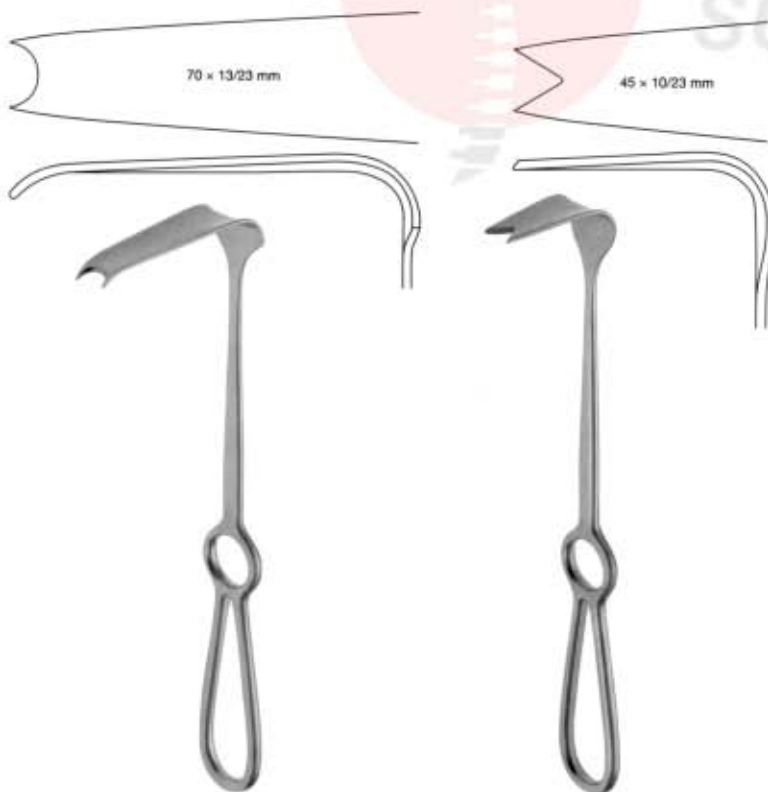

Obwegeser Alveolar (wisdom Tooth) Retractor,
09-328 22cm, 13/23 X 70mm

Obwegeser Nasal Spine Retractor,
09-329 22cm, 10/23 X 45mm



Obwegeser Iliac Crest Retractor
09-330 22cm
 30/60 X 60mm

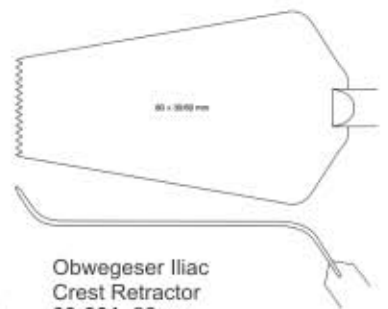

Obwegeser Iliac Crest Retractor
09-331 22cm
 30/60 X 80mm

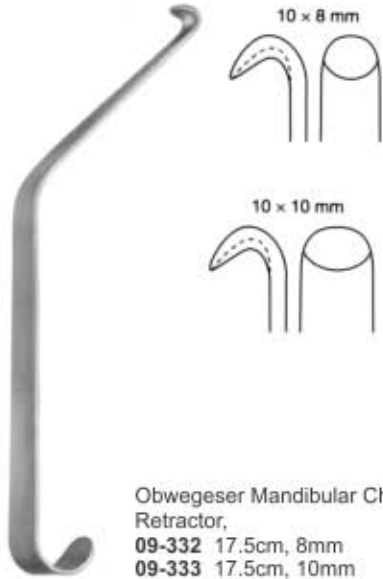

Obwegeser Mandibular Channel Retractor,
09-332 17.5cm, 8mm
09-333 17.5cm, 10mm



Obwegeser Chin Retractor,
09-334 16cm



Saldanha Solz Abdominal Retractor,
09-335 23.5cm



Killian Nasal Speculum With Fiber Optics Illumination
09-336



Deaver Retractor With Fiber Optics
09-337
 Illumination, 16mm
09-338
 Illumination, 25mm



Ferreira Face Lift Retractor With Fiber Optic Illumination 22 X 108mm
09-339



Freeman Flap Retractor With Fiber Optics Illumination,
09-340 20cm, 13mm
09-341 20cm, 25mm



09-342
 Mandibular Channel Retractor
 8mm,
 17.5cm



09-343
 Bremerich Mandibular Channel Retractor
 10mm, 18cm



09-344
 Ramus Retractor 20x80mm
 16cm
09-345
 Ramus Retractor 25x80mm
 16cm
09-346
 Ramus Retractor 30x80mm
 16cm
09-347
 Ramus Retractor 35x80mm
 16cm



09-348
 Medial Ramus Retractor
 left 19.5cm
09-349
 Medial Ramus Retractor
 right 19.5cm



09-350
Bremerich Channel
Retractor 10mm,
22.5cm w/suction



09-351
Extra Oral
Retractor
24cm



09-352
Intra Oral
Retractor
24cm



09-353
Intra Oral
Retractor
L and M
w/o F/O
fitting.
25cm



09-354
Intra Oral
Retractor
right w/o
F/O fitting.
21cm



09-355
Intra Oral
Retractor
left w/o
F/O fitting.
21cm



09-356
Intra Oral Retractor
w/o F/O
Fitting 23cm



09-357
Intra Oral Retractor
With
F/O fitting 23cm



09-358
Intra Oral Retractor
Left
with F/O fitting
21cm



09-359
Intra Oral Retractor
right
w/F/O fitting. 21cm



**Levasseur Merrill Fiber
Optic Retractor for
Vertical Osteotomies**
09-360 Length 25cm
Working Tip 27mm



**Shea with Fiber Optic
(Multipurpose Retractor)**
09-361 Length 25cm
Working Tip 14.5mm



**Brunner Retractors
with Fiber Optic**
09-362 Length 24cm
Blades 145 x 25mm



09-363
Cheek and Lip
Retractor D/E
21x30mm,
26x35mm, 18cm



09-364
Schwenzer Cheek
Retractor 65x50mm,
17cm



09-365
Reuther Lliac
Crest
Retractor 24cm



09-366
Tessier Rib Graft
Retractor adult
120x28mm, 20.5cm



09-367
Lester
Retractor



09-368
Richardson Retractor
28x20mm



09-369
Richardson Retractor
38x28mm

MANZIM
SURGICO



09-370
Richardson Retractor
38x37mm



09-371
Richardson Retractor
52x22mm



**Aufrich Nasal Retractors
with Fiber Optic**
09-372 16cm 7mm
09-373 18cm 10mm



**Harrington Retractors
with Fiber Optic**
09-374 40 x 127mm
09-375 60 x 127mm

for Right cheem

for Left cheem



**Bauer Retractor with
Fiber Optic**
09-376 26.5cm / 16mm
09-377 26.5cm / 16mm





Petri Pterygoid Retractor with Fiber Optic
09-378 23cm, 25.5mm



Sigmoid Nptch Retractor with Fiber Optic
09-379 22cm, 16mm



Maliniac Nasal Retractor with Fiber Optic
09-380 9mm x 45mm



09-381
Yancoskie Retractor
18cm, 6 sharp prongs



09-382
Coronal Brow Lift Retractor
18cm, 7 Sharp prongs



Freeman Retractor

09-383 18cm,
4 Sharp prongs
22mm, wide
09-384 18cm,
4 Blunt prongs
22mm, wide



Hook Retractor in-line prongs / four prongs 18cm
09-385 straight
09-386 narrow head
09-387 angled shaft

09-388 angled shaft 4 prong with shorter inner prongs 18cm



Anderson Bear Claw Retractor
09-389 12cm



Miniature model / with thumb ring / in-line prongs / four prongs
09-391 11.5cm



Miniature model / with thumb ring / in-line prongs / four prongs
09-390 6cm



Freeman Hook Retractor four Prongs / with shorter inner prongs / seven prongs
09-392 18 cm



Freeman Hook Retractor Seven Prongs / with shorter inner prongs / seven prongs
09-393 18 cm concave



Freeman Hook Retractor Seven Prongs / with shorter inner prongs / seven prongs
09-394 18 cm convex



**Rhinoplasty set
09-395**

01. Scalpel Handle, #7k.
02. Surgical Operating Scissors, 14.5cm, Curved - Sharp/Blunt
03. Ragnell Kilner Scissors, 15cm, Curved - Flattened At Distal End
04. Fox T.C. Gum And Tissue Scissors, 13cm, Curved, 1 Serrated Blade
05. Adson Brown Delicate Tissue Forceps, 12cm, 7x7 Teeth, Straight
06. Adson Brown Delicate Tissue Forceps, 12cm, 9x9 Teeth, Straight
07. Semken Delicate Tissue Forceps, 12.5cm, 2x3 Teeth, Straight
08. Debakey At Vascular Forceps, 15cm - 1.5mm Tips
09. Bayonet Grasping Forceps, 16cm
10. Bayonet Grasping Forceps, 16cm, 1x1 Teeth
11. Troeltsch Wilde Angular Forceps, 13cm, Adult Size - Serrated
12. Grooved Director And Tongue Tie, 11.5cm
13. Frazier Fergusson Suction Tube, 18cm, Angled, 10 French e
14. Senning T.C. Needle Holder, 17cm, Serrated
15. Halsted Micro Mosquito Forceps, 12.5cm, Curved
16. Backhaus Towel Clamp, 8.5cm
17. Gross Dressing Forceps, 20cm, Straight - Without Catch, Box Lock
18. Walter Cope Retractor, 17.5cm
19. Joseph Skin Hook, 16cm, Single Prong, Sharp
20. Guthrie Double Retractor Hook, 13cm, 2mm Wide, Sharp
21. Lempert Raspatory, 17cm, 4mm, Delicate, Sharp
22. Supercut Walter Dorsal Scissors, 14cm, Angular
23. Supercut Walter Cottle Dorsal Scissors, 16cm, Curved
24. Medicon Mallet, 18.5cm, Plastic Facings, 200 Grams, 25mm Diameter
25. Walter Williger Bone Curette, 13.5cm, 2/2mm, Double Ended, Sharp, Angled
26. Defourmental Bone Rongeur, 19cm, Straight, Slender Beaks - Jaws 3mm Wide
27. Weil Blakesley Wilde Ethmoid Bone Forceps #3, 120mm Shaft, 4.2mm
28. Weil Blakesley Wilde Ethmoid Bone Forceps #2, 45 Degree Angle, 120mm Shaft, 3.6mm
29. Myles Nasal Through Cutting Forceps #4, 120mm Shaft
30. Cottle Nasal Septum Speculum, 14cm, 50mm
31. Cottle Elevator, 16cm, 2.5mm
32. Masing Septum Elevator, 22cm, 5/5mm, Double Ended
33. Aufricht Walter Nasal Retractor, 13.5cm, Double Ended, Sharp, 42x7mm
34. Aufricht Walter Nasal Retractor, 13.5cm, Double Ended, Blunt, 38x7mm
35. Walter Chisel/Osteotome, 19cm, 3mm, Modified
36. Walter Chisel/Osteotome, 19cm, 5mm, Modified
37. Walter Osteotome, 19cm, 2mm, Straight
38. Walter Osteotome, 19cm, 12mm, Straight
39. Walter Chisel/Osteotome, 19cm, 12mm, Modified
40. Walter Osteotome, 19cm, 6mm, Curved
41. Walter Cantanares Lifting Scissors, 16cm, Curved
42. Fomon Rhinoplasty Scissors, 12.5cm
43. Cottle Columella Forceps, 11cm
44. Fomon Bone And Nasal Rasp, 20cm
45. Asch Septum Straightening Forceps, 22cm, Angled
46. Brunings Tongue Depressor, 19cm, 14mm

MANZIM
SURGICO

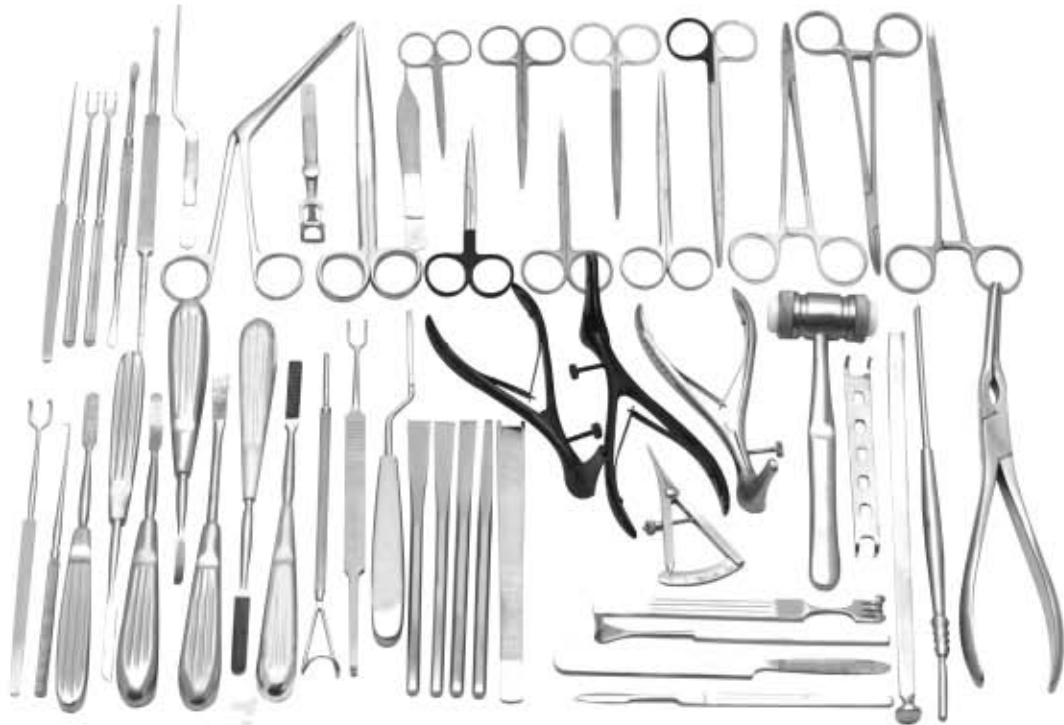

**Rhinoplasty set
09-396**

Steel Ruler 6" -----	1
Metz Lahey Crv Del 5 3/4" Tc-----	1
Metz Sciss Cvd Del 7 Tc-----	1
Crile Wood Nh Serr 7" Tc"-----	1
Mallet W/Repl Plst Discs -----	1
Maltz Rasp 7" Bkd Cut-----	1
Joseph Rasp Fine Crss Serr 6 1/4"-----	1
Aufricht Glabellar Rasps 8" Bkd-----	1
Cottle Dorsal Sciss Ang 6 1/2"-----	1
Black Cotted Cottle Septal Spec 2"-----	2
Cottle Elev Cm-Grad D/E 9-----	1
Joseph Perio Elev 7" X6.5Mm-----	1
Joseph Perio Elev 6 1/4" X4.5Mm-----	1
Cottle Nasal Knife Sh 5 1/2" 4Mm-----	1
Cottle Nasal Osteo 6 1/2" Cvd-----	1
Cinelli Osteo Grd 2Sd Str 10Mm-----	1
Cot Knife Grd/Retr 8" 5Mm Hook-----	1
Neiv Knife Gd/Retr 6 1/2" D-End-----	1
Cottle Ret 5 1/2" 4Prng 2Reces-----	1
Fomon Retr Ball End Dbl 6 1/4"-----	1
Converse Alar Retr D/E 4 1/2"-----	1
Iris Sciss Str S/S 3 1/2"-----	1
Freer Elevator De Sh/BI 7 1/4"-----	1
Joseph Hook 1/Pr Sh 6 1/4"-----	1
Joseph Hook 2/Pr Sh 6 1/4" 5Mm-----	2
Gillies Skin Hook 7" 3Mm-----	1
Adson Dressing Fcp Serr 4 3/4"-----	1
Strabismus Sciss Str 4 1/2"-----	1
Strabismus Sciss Crv 4 1/2"-----	1
Desmarres Lid Retr 12Mm-----	1
Castroviejo Caliper 3 1/4"-----	1
Cottle Columella Fcp 4 1/2"-----	1
Hartman Ear Fcp Light Serr Jaw-----	1
Jansen Nasal Fcp Bayonet 6 1/2"-----	1
Sheehan Osteo Str 6 1/4" 4Mm-----	1
Sheehan Osteo Str 6 1/4" 8Mm-----	1
Sheehan Osteo Str 6 1/4" 10Mm-----	1
Sheehan Osteo Str 6 1/4" 12Mm-----	1
Killian Med W/Set Screw 3"-----	1
Foman Nas Low Lat Scis Cv 5 3/4"-----	1
Ash Sept Straightening Fcp 9"-----	1
Ballenger Swivel Knife 4Mm-----	1
Joseph Bone Saw Str 7 1/2"-----	1
Schmidt Half Crv Tons Fcp 7 1/2"-----	2
Maltz Rasp Se Fine Tc-----	1
Maltz Rasp Se Medium Tc-----	1

**MANZIM
SURGICO**

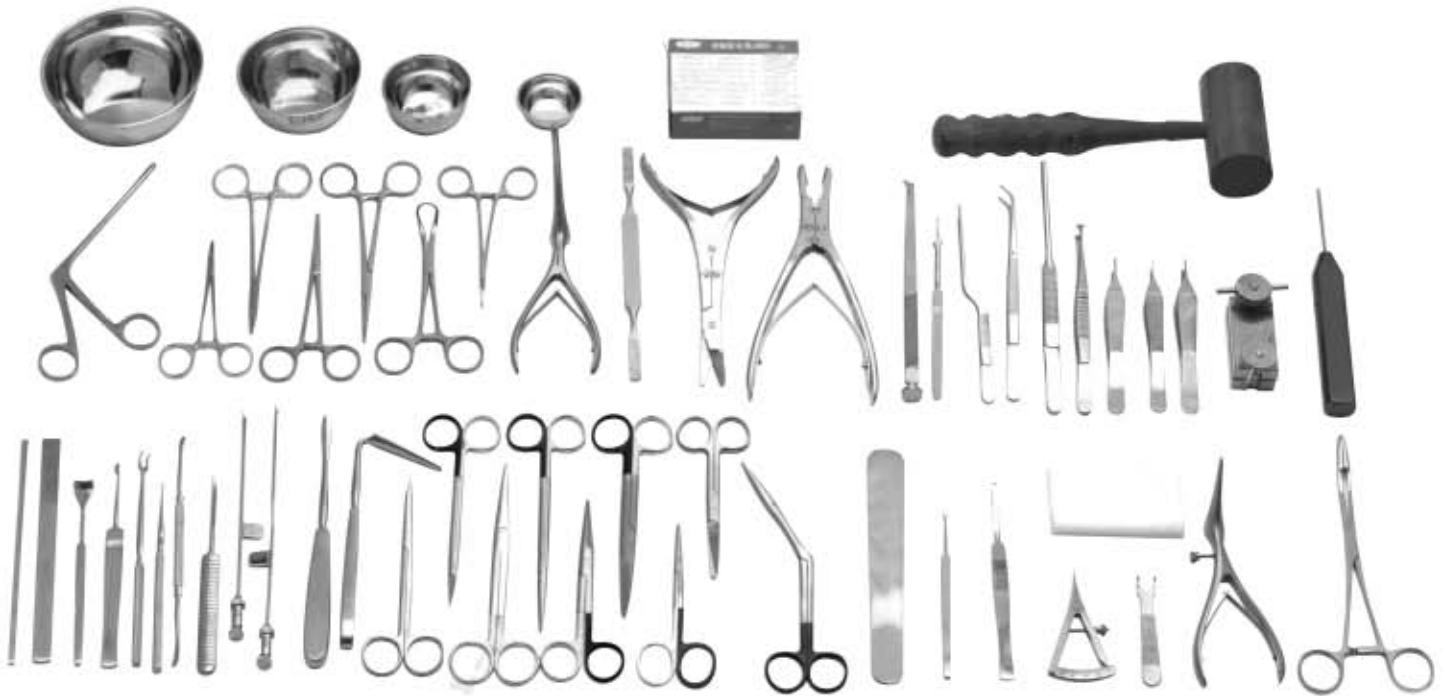

**Rhinoplasty set
09-397**

01. Scalpel Blades #15 - Sterile,
02. Scalpel Handle, #7
03. Surgical Operating Scissors, 13cm, Straight - Sharp/Blunt
04. Mayo Stille T.C. Operating Scissors, 17cm, Curved
05. Reynolds Jameson Scissors, 14cm, Curved - With Fine, Rounded Points
06. Adson T.C. Tissue Forceps, 12cm
07. Micro Adson Forceps, 12cm, 1x2 Teeth - 0.8mm Tips
08. Adson Brown Delicate Tissue Forceps, 12cm, 7x7 Teeth, Straight - Atraumatic
09. Dressing Forceps, 20cm - Modified Swedish Pattern
10. Nelson Tissue Forceps, 15cm
11. Gruenwald Jansen Nasal Dressing Bayonet Forceps, 16cm, Serrated
12. Gubisch T.C. Needle Holder, 12.5cm, Extra Fine
13. Crile Wood T.C. Needle Holder, 15cm
14. Halsted Micro Mosquito Forceps, 12.5cm, Curved
15. Leriche Artery Forceps, 15cm, 1x2 Teeth, Straight
16. Pean Hemostatic Forceps, 14cm, Straight
17. Backhaus Towel Clamp, 13cm
18. Dressing Forceps, 17.5cm, Curved, Delicate
19. Gross Dressing Forceps, 20cm, Curved - With Catch, Box Lock
20. Barsky Skin Hook, 15cm, Single Prong, Sharp
21. Joseph Delicate Retractor, 17cm, 2 Prong, 5mm, Sharp
22. Guthrie Double Retractor Hook, 13cm, Sharp
23. Supercut Plus T.C. Mayo Scissors, 14cm, Straight
24. Supercut Plus T.C. Mayo Scissors, 17cm, Curved
25. Supercut Plus Metzenbaum T.C. Scissors, 18cm, Curved
26. Supercut Plus Kelly T.C. Scissors, 16cm, Curved
27. Langenbeck Bone Elevator, 20cm, 7mm, Blunt
28. Freer Raspatory, 19cm, 5/5mm, Double Ended, Sharp / Sharp
29. Williger Raspatory, 16cm, 5mm, Sharp
30. Mckenty Raspatory, 15cm, 4mm, Sharp, Light Curve
31. Supercut Heymann Nasal Scissors, 18cm
32. Supercut Plus Fomon T.C. Dorsal Scissors, 13cm, Angular
33. Mallet, 26cm, Novotex Plastic, 240 Grams, 45mm Diameter
34. Round Bowl For Solutions, 40x20mm, 20cc
35. Round Bowl For Solutions/Marking Color, 60x30mm, 60cc
36. Round Bowl For Solutions, 80x40mm, 160cc
37. Round Bowl For Solutions, 110x55mm, 400cc
38. Castroviejo Caliper, 7cm, 20mm Measuring Range
39. Desmarres Lid Retractor #2, 14cm, Medium, 10x14mm
40. Killian Asept Nasal Speculum, #4, 90mm (Modified)
41. Weil Blakesley Wilde Ethmoid Bone Forceps #3, 120mm Shaft, 4.2mm
42. Freer Septum Knife (Mucosa Scalpel), 16cm
43. Cottle Nasal Speculum, Delicate, 15cm, 55mm
44. Gubisch Suction Raspatory With Guide And Bypass Hole, 20cm, 4mm
45. Gubisch Suction Raspatory With Guide, 17cm, 4mm
46. Cartilage Cutting Block, Teflon, 85x55x10mm
47. Gubisch Cartilage Crusher, 65x30mm
48. Gubisch Kilner Double Nasal Hook (Alar Retractor), 8cm, Sharp, 5x10mm
49. Gubisch Aufricht Nasal Retractor, 17cm, 50x6-12mm
50. Cottle Gubisch Chisel, 18cm, 5mm, Graduated, Hollow Cut
51. Cottle Gubisch Chisel, 18cm, 12mm, Graduated, Hollow Cut
52. Gubisch Osteotome, 18.5cm, 3mm, Aluminium Handle
53. Fanous Osteotome, 19.5cm, 4mm, Straight, With Guide Thorn - 1)
54. Caplan Nasal Septum Scissors, 20cm, Serrated
55. Gubisch Fomon Nasal Rasp, 20cm
56. Rubin Septal Morselizer Forceps, 20cm, With Protective Guard
57. Buchwald Tongue Spatula, 18cm, 18x23mm

Rhinoplasty set
09-398

- Adson Forceps TC, Serrated, 12cm 2
 Aston SuperCut Scissors, 5 1/2" (14cm), Angled, Serrated 1
 Aufricht Nasal Retractor with Fiber Optic Light Guide, 7" (18cm), 1.75in Tapered 1
 Backhaus Towel Forceps, 3 1/2" (9cm) 2
 Beasley-Babcock Forceps, 4 3/4" (12cm), 3.5mm tips 1
 Bishop-Harmon Forceps, 3 1/2" (9cm), 1x2 teeth, 0.6mm tips 2
 Boies Nasal Fracture Elevator, 7 3/4" (19.5cm) 1
 Brown-Adson Forceps, 4 3/4" (12cm), Brown teeth 1
 Caplan Nasal Shears Scissors, 7 3/4" (19.5 cm), Angled, Serrated 1
 Castroviejo Caliper, 3 1/2" (9cm) 1
 Cottle Cartilage Crusher Morselizer 1
 Cottle Double-Ended Septum Elevator, 8 1/2" (21cm), 4mm/3mm, Sharp/Blunt 1
 Cottle Modified Nasal Speculum, 5 1/2" (14cm), 50mm 1
 Cottle Retractor, 5 1/2" (14cm), 2 Sharp Prongs 1
 Cushing Bayonet Insulated Bipolar Forceps, 7 1/4" (18.5cm), 1mm tips, American Pattern 1
 Foerster Sponge Holding Forceps, 7" (18cm) 1
 Fomon TC Rasp, 8 1/2" (21.5cm), #3 & #4, Double 1
 Fomon TC Rasp, 8 1/2" (21.5cm), #5 & #6, Double 1
 Fomon TC Rasp, 8 1/2" (21.5cm), #7 & #8, Double 1
 Frazier Suction Tubes 10 French 2
 Freer Chisel, 6 1/2" (17cm), 4mm 1
 Gerzog Stainless Steel Mallet (Lead filled) 1
 Goldman Septum Elevator, 7 1/4" (18.4cm), 6mm 1
 Gunter Lower Lateral Longitudinal Jaw Morselizer, 7" (18cm) 1
 Guthrie Double Hook, 4 3/4" (12cm), 2.5mm 2
 Halsey Needle Holder, 5" (13cm), Delicate, Smooth Jaw 2
 Halstead Mosquito Forceps, Curved, 5" (12.5cm) 1
 Iris SuperCut Scissors, 4 1/2" (11.5 cm), Curved, Serrated 1
 Jansen Middleton Forceps, 7 3/4" (19.5cm), Large Fenestrated jaw 1
 Joseph Nasal Saw Left Bayonet, 7 1/4" (18.5 cm) 1
 Joseph Nasal Saw Right Bayonet, 7 1/4" (18.5 cm) 1
 Joseph Periosteal Elevator, 6 1/2" (16.5cm) 1
 Joseph Skin Hook, 6 1/4" (16cm), 10mm Double Hook 1
 Joseph Skin Hooks, 6 1/4" (16cm), 5mm Double Hook 1
 Joseph Skin Hooks, 6 1/4" (16cm), Single Hook 2
 Knife Handle #3, 5" (12.5 cm) for B-P (10-15) blades 4
 Lempert Rongeur, 6 1/4" (16cm), 2.5mm tips 1
 Lucae Nasal Dressing Forceps, 5 1/2" (14cm), Serrated jaw 1
 Mitchells Trimmer Double-Ended Elevator, 6 5/8" (17cm) 1
 Operating Sharp/Blunt TC Scissors, 5 1/2" (14 cm), Straight 1
 Pean Hemostatic Forceps, Straight, 6 1/4" (16cm) 2
 Pennington Double-Ended Elevator, 8 1/2" (22cm), 4mm/4.5mm 1
 Ribbon Suture Scissors, 3 3/4" (9.5 cm), Curved 1
 Senn Double-Ended Blunt Retractor, 6 1/4" (16cm), blade 1/4in x 3 sharp prongs 2
 Sheen Cartilage Grid 1
 Sheen Fragment Forceps, 7" (18cm) 1
 Silver Osteotome, 7" (18cm) Left 1
 Silver Osteotome, 7" (18cm) Right 1
 Silver Osteotome, 7" (18cm) Straight 1
 Spencer Stitch Removal Scissors, 3 1/2" (9 cm), Straight 1
 Strabismus SuperCut Scissors, 4 1/2" (11.5 cm), Curved, Serrated 1
 SuperCut Scissors, 7 1/2" (19cm), Angled, Serrated 1
 Walsham Septal Forceps, 9" (23cm), 7mm x 33mm Jaws 1
 Webster Glabella TC Rasp, 8 1/2" (21.5cm), Coarse, Push/Pull 1
 Webster TC Needle Holder, 4 1/2" (11.5cm), Delicate, Smooth Jaw 1
 Woodson Double-Ended Elevator, 7" (18cm), straight/angled 1

BONE SURGERY INSTRUMENTS

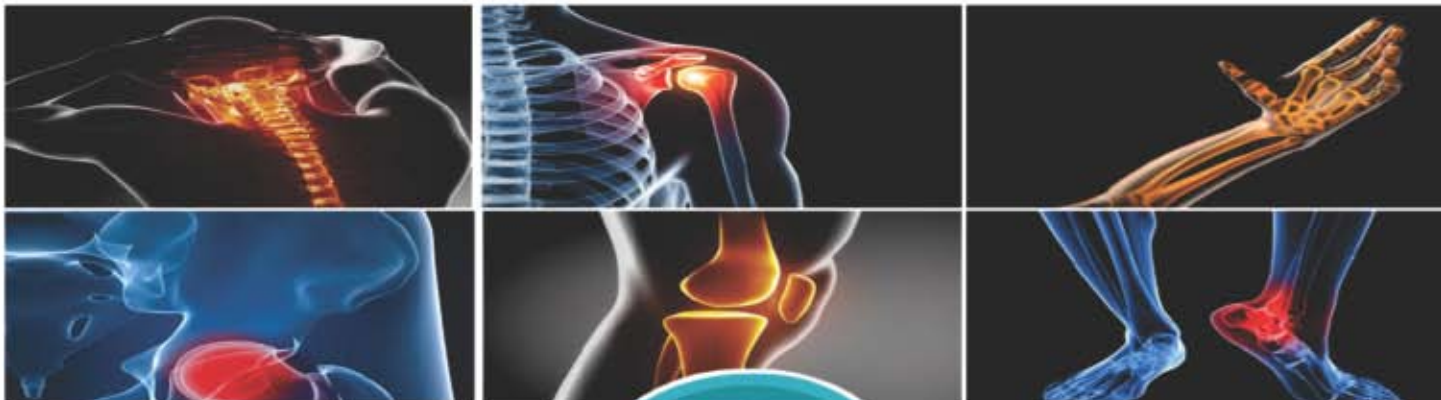

amputations-und resektiossagen | sierra para amputacion y reseccion
Scies a amputation et resection | seghe per amputazione



Satterlee Saw
10-001 29cm
Stainless Steel Ring Handle
Straight tip, Straight shaft



Charriere Bone Saw
10-002 27cm
10-003 30cm
10-004 34cm
Straight tip, Straight shaft



Charriere Saw
10-005 35cm
Spare saw blades
10-006 12mm
10-007 15mm



Charriere Bone Saw Complete
10-008 35.5cm
Straight tip,
Straight shaft



Helferich-Bier Saw
10-009 39cm
Spare saw blades
10-010 3mm
10-011 5mm
10-012 5mm



Charriere Saw
10-013 25 cm
10-014 27 cm
Double saw

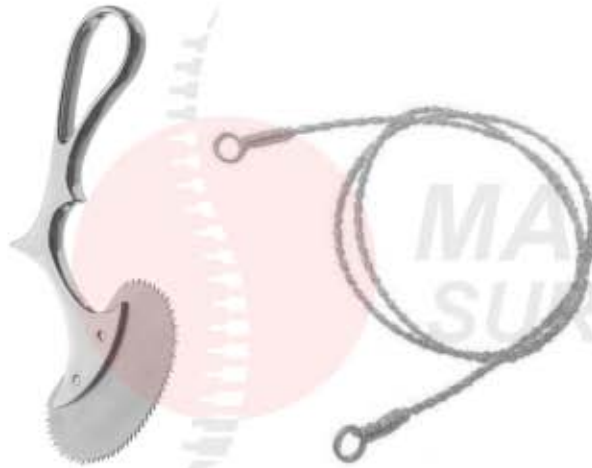

Engel Plaster Saw
10-015 15.5 cm



Serra Gigli
10-016 30 cm
10-017 40 cm
10-018 50 cm



Percy Amputation Shield
10-019 30.5cm
Handles Detachable,
Simple Pattern



Putti Bone Rasp
10-020 27cm
Double ended,
One end curved up
one end curved sideways



Putti Rasp
10-021 30cm
Double Ended



Putti Bone File
10-022 28cm
semicircular



Putti Bone File
Bayonet Shape
10-023 24.5cm
X=13 mm
semicircular



Putti Bone File
10-024 22cm
X=20 mm
flat



Joseph Bone Saw / Rasp
10-025 19cm
Single Sided



Linderman Amputation Saw
10-026 19cm
20cm Blade



Wellenschliff Nasal Saw
10-027 19cm
Straight



Langenbeck Metacarpal Saw
10-028 23cm
11.5cm Blade

Knochenfeilen

Limes à os

Limas para huesos

Lime per ossa



Patella Bone Saw
10-029 Includes 1 blade
10-030 Replacement blade only
 Delrin Handle



Foman Rasp
10-031 21.5cm
 Double ended, Fine & coarse serrations 4-sided convex and flat blades



Foman Rasp
10-032 21cm

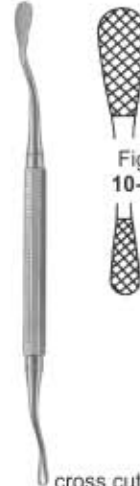

Miller-Colburn Bone File
 18 cm



Fig. 1
10-033



Fig. 2
10-034

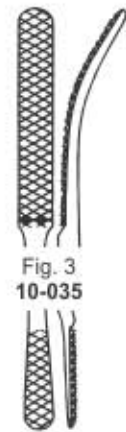

Fig. 3
10-035



Fig. 4
10-036

cross cut



Kleinert-Kutz Bone Rasp
10-037 22.5cm
 Double ended,
 Fine & course serrations



Miller Alveotomy File
10-038 19cm



Miller Alveotomy File
10-039 19cm



Gallaher Bone Rasp
10-040 18cm
10-041 25cm
 Curved



Gallaher Bone Rasp
10-042 18cm
10-043 25cm
 Convex Curve



Gallaher Bone Rasp
10-044 18cm
10-045 25cm
 Straight



Good Bone File / Rasp
10-046 16.5cm
 Straight



Kistler Ear Cartilage Rasp
10-047 left
10-048 right
 16.5cm Curved



Micro Rasp
10-049 14cm
 Single ended
 double sided



Nail Rasp
10-050 17cm
 Single sided



Maltz Rasp
10-051 18cm
 Single-Ended
 Single sided



Improved Maltz Rasp
10-052 18cm
 Single-Ended,
 up & down rasping



Putti Rasp
10-053 23cm
 flat / flat
10-054 30.5cm
 Round / flat

Raspeln, Feilen
Rapes, Limes

Escofinas, limas
Raspe, lime



Miller Rasp
10-055 21.5cm
Double Ended straight
single Sided



Fomon Rasp
10-056 21.5cm
Double Ended straight
single Sided
one side concave



Fomon Rasp
10-057 21.5cm
Double Ended straight
single Sided
one side convex



Fomon Rasp
10-058 21.5cm
Double Ended straight
single Sided



Fomon Rasp
10-059 21.5cm
Double Ended straight
single Sided
one side concave



Fomon Rasp
10-060 21.5cm
Double Ended straight
single Sided
one side convex



Chisel Blade Handle
10-061 18.5cm



10-062 8.5cm
5mm
10-063 8.5cm
10mm
10-064 8.5cm
16mm
10-065 8.5cm
25mm



10-066 8.5cm
5mm
10-067 8.5cm
10mm
10-068 8.5cm
16mm
10-069 8.5cm
25mm



Chisel Blade key
10-070 9cm



Osteotome
13.5cm
10-071 8mm
10-072 10mm
10-073 12mm
10-074 14mm
10-075 16mm



Chisel
13.5cm
10-076 8mm
10-077 10mm
10-078 12mm
10-079 14mm
10-080 16mm



Gouge
13.5cm
10-081 8mm
10-082 10mm
10-083 12mm
10-084 14mm
10-085 16mm



Lucas Chisel
16cm
10-086 3mm
10-087 4mm
10-088 5mm
10-089 6mm



Lucas Gouge
16cm
10-090 3mm
10-091 4mm
10-092 5mm
10-093 6mm



**U.S. Army Pattern
Chisel**
16.5 cm
10-094 6 mm wide
10-095 12 mm wide
10-096 18 mm wide



Partsch Chisel	Partsch Chisel	Partsch Chisel
11.5cm	13.5cm	17.5cm
10-097 2mm	10-103 2mm	10-109 2mm
10-098 3mm	10-104 3mm	10-110 3mm
10-099 4mm	10-105 4mm	10-111 4mm
10-100 6mm	10-106 6mm	10-112 6mm
10-101 7mm	10-107 7mm	10-113 7mm
10-102 8mm	10-108 8mm	10-114 8mm

Knochenmeißel
Ciseaux-burins, gouges

Cineles, gubias
Scalpelli, sgorbi



Partsch Gouge	Partsch Gouge	Partsch Gouge
11.5cm	13.5cm	17.5cm
10-115 2mm	10-121 2mm	10-127 2mm
10-116 3mm	10-122 3mm	10-128 3mm
10-117 4mm	10-123 4mm	10-129 4mm
10-118 6mm	10-124 6mm	10-130 6mm
10-119 7mm	10-125 7mm	10-131 7mm
10-120 8mm	10-126 8mm	10-132 8mm



Alexander Chisel
18cm

10-133 4mm
10-134 6mm
10-135 8mm
10-136 10mm
10-137 12mm
10-138 14mm



Alexander Gouge
18cm

10-139 4mm
10-140 6mm
10-141 8mm
10-142 10mm
10-143 12mm
10-144 14mm



Smith Peterson Gouge

20cm Straight

10-145 09 mm
10-146 14 mm
10-147 19 mm
10-148 25 mm

Curved

10-149 09 mm
10-150 14 mm
10-151 19 mm
10-152 25 mm



Straight

10-153 06 mm
10-154 09 mm
10-155 13 mm
10-156 16 mm
10-157 19 mm
10-158 25 mm
10-159 32 mm

Curved

10-160 06 mm
10-161 09 mm
10-162 13 mm
10-163 16 mm
10-164 19 mm
10-165 25 mm
10-166 32 mm

Smith Peterson Osteotome
20 cm



Straight

10-167 10 mm
10-168 15 mm
10-169 20 mm
10-170 25 mm

Curved

10-171 10 mm
10-172 15 mm
10-173 20 mm
10-174 25 mm

Stille Gouge
20 cm



Stille
20 cm



Stille Chisel
20 cm



10 mm
10-185



15 mm
10-186



20 mm
10-187

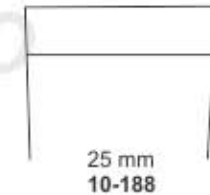

25 mm
10-188

Chisels

10-175 10 mm
10-176 12 mm
10-177 15 mm
10-178 20 mm
10-179 25 mm

Osteotome

10-180 10 mm
10-181 12 mm
10-182 15 mm
10-183 20 mm
10-184 25 mm



Stille Osteotome
20 cm



10 mm
10-189



15 mm
10-190



20 mm
10-191

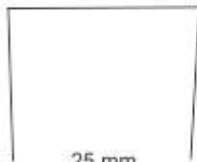

25 mm
10-192



Lexer Osteotome
22 cm

10-193 7 mm
10-194 10 mm
10-195 12 mm
10-196 15 mm
10-197 20 mm
10-198 25 mm
10-199 30 mm

Lexer Modif. Osteotome
29 cm

10-200 7 mm
10-201 10 mm
10-202 12 mm
10-203 15 mm
10-204 20 mm
10-205 25 mm
10-206 30 mm



Lexer Modif. Chisel
29 cm

10-207 7 mm
10-208 10 mm
10-209 12 mm
10-210 15 mm
10-211 20 mm
10-212 25 mm
10-213 30 mm

Lexer Chisel
22 cm

10-214 7 mm
10-215 10 mm
10-216 12 mm
10-217 15 mm
10-218 20 mm
10-219 25 mm
10-220 30 mm



Lexer Gouge

25 cm
10-221 7 mm
10-222 10 mm
10-223 15 mm
Straight

Knochenmeißel
Ciseaux-burins, gouges

Cineles, gubias
Scalpelli, sgorbi



Lexer Gouge
25 cm
10-224 7 mm
10-225 10 mm
10-226 15 mm
Curved



Lexer Osteotome Flat
22 cm
10-227 10 mm
10-228 15 mm
10-229 20 mm
10-230 25 mm



Lexer Gouge Tuffnel Handle
22 cm
10-231 10 mm
10-232 15 mm
10-233 20 mm
10-234 25 mm



Mini Lexer Osteotome
10-235
18 cm



Mini Lexer Chisel
10-236
18 cm



Capener Osteotome With Tuffnel Handle
25cm
10-237 10mm
10-238 12mm
10-239 15mm
10-240 20mm
10-241 25mm
10-242 30mm
Straight



Capener Osteotome With Tuffnel Handle
25cm
10-243 10mm
10-244 12mm
10-245 15mm
10-246 20mm
10-247 25mm
10-248 30mm
Curved



Capener Chisels With Tuffnel Handle
25cm
10-249 6mm
10-250 8mm
10-251 10mm
10-252 12mm
10-253 15mm
10-254 20mm
10-255 25mm
10-256 30mm
Straight



Capener Osteotome With Tuffnel Handle
25cm
10-257 6mm
10-258 8mm
10-259 10mm
10-260 12mm
10-261 15mm
10-262 20mm
10-263 25mm
10-264 30mm
Curved



Raspatories
10-265 20cm
Medium straight blade
round edge, width 14mm



Raspatories
10-266 20cm
Large straight blade
round edge, width 20mm



Raspatories
10-267 20cm
Medium curved blade
round edge, width 14mm



Raspatories
10-268 20cm
Large curved blade
round edge, width 20mm



Mini Lexer Osteotome
10-269 20cm
18mm



Raspatories
10-270
28cm



Raspatories
10-271
28cm



Chisel
10-272
115mm/280mm
for extraction of cement

Knochenmeißel

Cineles, gubias

Ciseaux-burins, gouges

Scalpelli, sgorbi



Chisel
10-273
for extraction
of cement 9mm
Positive 400mm



Chisel
10-274
with 2 prong



**Lambotte
Osteotome**
25cm
10-275 6mm
10-276 8mm
10-277 10mm
10-278 13mm
10-279 15mm
10-280 20mm
10-281 25mm
10-282 30mm
10-283 38mm
10-284 44mm
10-285 50mm
Straight

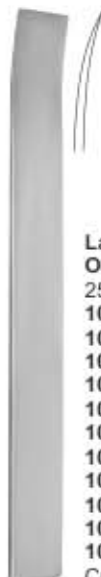

**Lambotte
Osteotome**
25cm
10-286 6mm
10-287 8mm
10-288 10mm
10-289 13mm
10-290 15mm
10-291 20mm
10-292 25mm
10-293 30mm
10-294 38mm
10-295 44mm
10-296 50mm
Curved



**Mini-Lambotte
Osteotome**
12.5cm
10-297 3mm
10-298 4mm
10-299 6mm
10-300 8mm
10-301 10mm
10-302 12mm
10-303 15mm
Straight



**Mini-Lambotte
Osteotome**
17cm
10-304 3mm
10-305 4mm
10-306 6mm
10-307 8mm
10-308 10mm
10-309 12mm
10-310 15mm
Straight



Lambotte Osteotome
12.5cm, Straight
10-311 2mm tip width
10-312 4mm tip width
10-313 6mm tip width
10-314 8mm tip width
10-315 10mm tip width
10-316 12mm tip width
10-317 15mm tip width



Hex Handle Osteotome
15cm, Straight
10-318 2mm tip width
10-319 3mm tip width
10-320 4mm tip width
10-321 5mm tip width
10-322 6mm tip width
10-323 7mm tip width
10-324 9mm tip width
10-325 10mm tip width



Cottle Osteotome
18.5cm, Straight
10-326 4mm tip width
10-327 6mm tip width
10-328 9mm tip width
10-329 12mm tip width



**Anderson-Nievert
Osteotome**
20.4cm
10-330 Curved right
10-331 Curved left
10-332 Straight



Freer Gouge
10-333 15cm
06mm



Freer Chisel
10-334 16cm
04mm



**Shoulder
Penetrating Gouge**
10-335 21.6cm
Straight, 3mm distal tip



**Ballenger
Chisel** 16cm
10-336
4mm
10-337
6mm
10-338
8mm



**Mannerfelt
Modif.**



Osteotomes
10-339 4mm
10-340 6mm
10-341 8mm
15.5cm



Gouge
10-342
4mm
15.5cm



**Kilian,
Septum Gouge**
10-343 16cm
5mm



**Kilian-Claus
Septum Gouge**
10-344 16cm
5mm

Knochenmeißel

Ciseaux-burins, gouges

Cineles, gubias

Scalpelli, sgorbi



Stille
20cm



Stille Chisel
10-345 10mm
10-346 15mm
10-347 20mm
10-348 25mm
Straight



Stille Osteotome
10-349 10mm
10-350 15mm
10-351 20mm
10-352 25mm
Straight



Stille Osteotome
10-353 10mm
10-354 15mm
10-355 20mm
10-356 25mm
Curved



Stille Gouge
10-357 10mm
10-358 15mm
10-359 20mm
10-360 25mm
Straight



Stille Gouge
10-361 10mm
10-362 15mm
10-363 20mm
10-364 25mm
Curved



Smith-Petersen
20cm 8"



Smith-Petersen osteotome
10-365 6mm
10-366 9mm
10-367 13mm
10-368 16mm
10-369 19mm
10-370 25mm
10-371 32mm
Straight



Smith-Petersen Osteotome
10-372 6mm
10-373 9mm
10-374 13mm
10-375 16mm
10-376 19mm
10-377 25mm
10-378 32mm
Curved



Smith-Petersen Gouge
10-379 9mm
10-380 16mm
10-381 19mm
10-382 25mm
Straight



Smith-Petersen Gouge
10-383 9mm
10-384 16mm
10-385 19mm
10-386 25mm
Curved



Hoke Osteotome
14cm
10-387 3mm
10-388 5mm
10-389 7mm
10-390 8.5mm
10-391 10mm
10-392 12mm



Hibbs
24cm



Hibbs Osteotome
10-393 6mm
10-394 13mm
10-395 19mm
10-396 25mm
10-397 32mm
Straight



Hibbs Chisel
10-398 6mm
10-399 13mm
10-400 19mm
10-401 25mm
10-402 32mm
Straight



Hibbs Osteotome
10-403 6mm
10-404 13mm
10-405 19mm
10-406 25mm
10-407 32mm
Curved



Hibbs Gouge
10-408 6mm
10-409 13mm
10-410 19mm
10-411 25mm
10-412 32mm
Straight



Hibbs Gouge
10-413 6mm
10-414 13mm
10-415 19mm
10-416 25mm
10-417 32mm
Curved

Knochenmeißel
Ciseaux-burins, gouges

Cineles, gubias
Scalpelli, sgorbi

Cottle Osteotome
10-418 7mm
10-419 12mm
15cm

Cottle Osteotome
10-420 19cm
04mm

Cottle Osteotome with depth markings
10-421 18cm
06mm

Fomon Chisel
17cm

10-422 04mm
10-423 07mm
10-424 05mm
10-425 08mm
10-426 06mm

Cinelli Chisel
18cm

10-427 10mm
10-428 12mm
10-429 14mm
10-430 16mm

Cottle Osteotome
18cm

10-431 04mm
10-432 09mm
10-433 07mm
10-434 12mm

10-435 18cm
16mm Protected and depth markings

Cottle Chisel
18cm

10-436 04mm
10-437 09mm
10-438 07mm
10-439 12mm

Cottle Osteotomes
10-440 18cm
06mm Cross bar and depth markings

Cottle Osteotomes
10-441 18cm
16mm Cross bar and depth markings

Hoke Osteotome
13.5cm
Curved

10-442 3mm tip width
10-443 4mm tip width
10-444 6mm tip width
10-445 8mm tip width
10-446 10mm tip width
10-447 13mm tip width
10-448 16mm tip width
10-449 19mm tip width

Walter Gouge
19cm

10-450 3mm
10-451 4.5mm

10-452 4mm
10-453 9mm
10-454 7mm
10-455 12mm

Cottle Osteotome
20cm

10-456 10mm
10-457 12mm
10-458 14mm

Rubin osteotome with stabilizer to reduce chance of twisting for more control
18cm

10-459 18cm Straight
10-460 18cm right
10-461 18cm Left

Silver Rhinoplastic Chisel

10-462 20cm Straight
10-463 20cm right
10-464 20cm Left

Neivert-Anderson osteotome

Meißel zur Nasenplastik

Osteotomes, ciseaux-burins pour rhinoplastique

Cinceles para rinoplastica

Scalpelli per plastica nasale

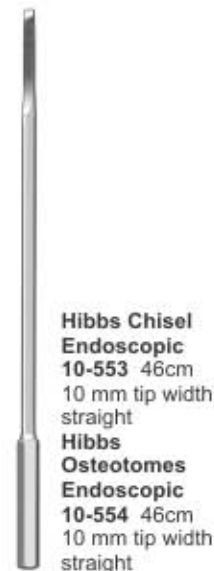
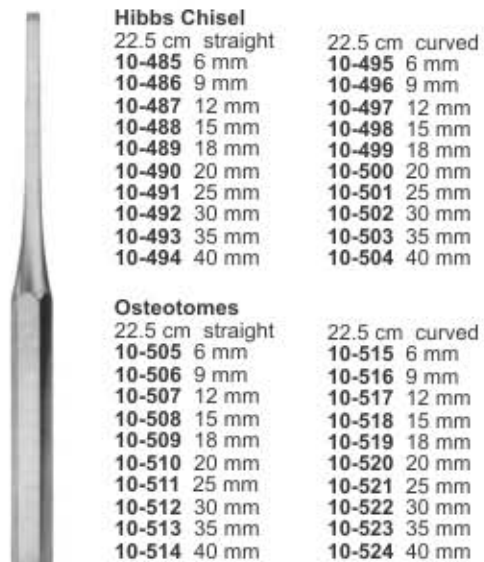
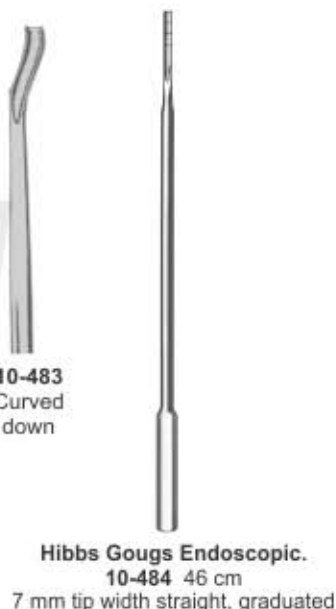
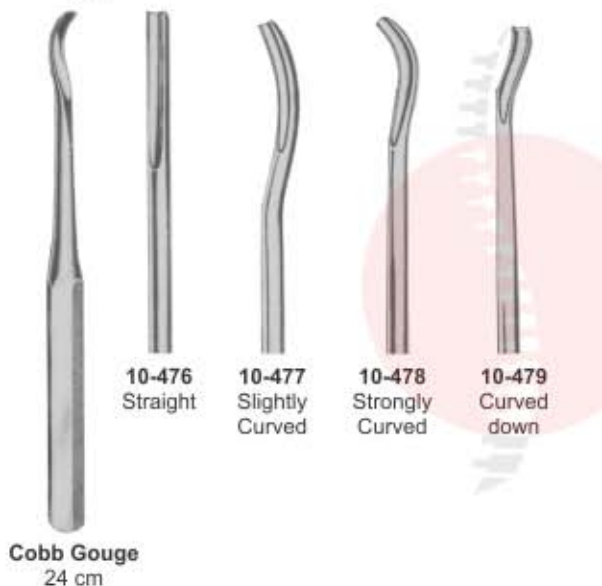
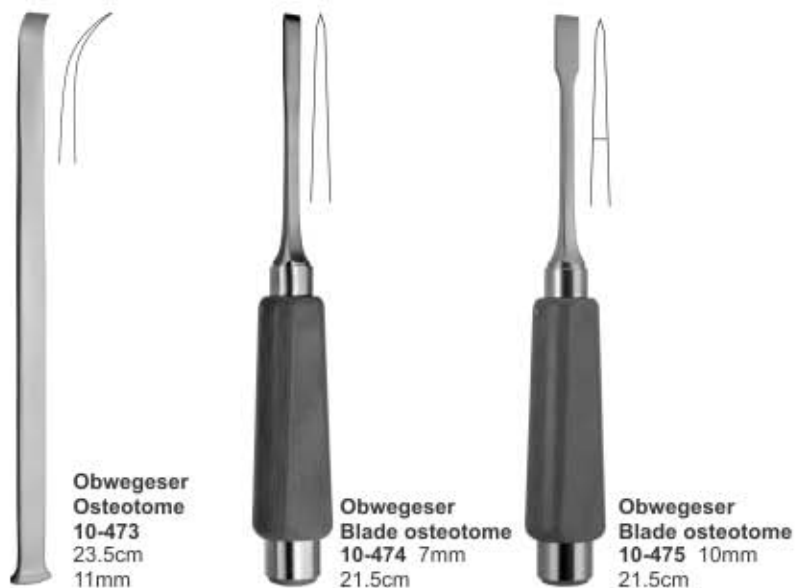
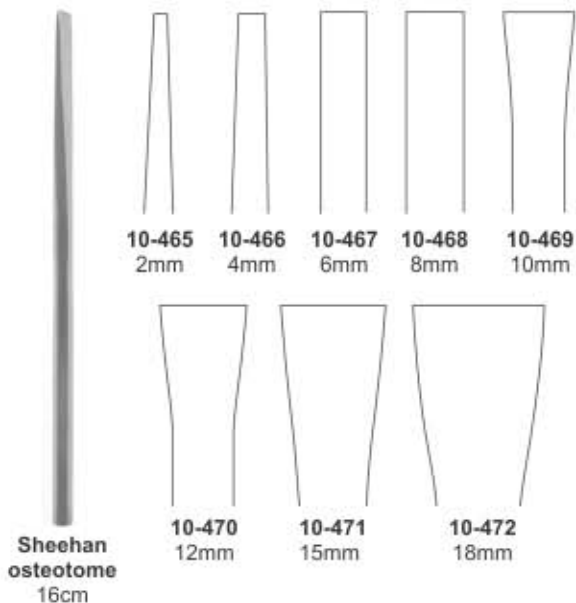

Hibbs Chisel / Osteotomes

Cobb Chisel / Osteotomes

Hammer | Martillos
Maillets | Martelli



Doyen Mallets
25cm
10-555
25mmØ - 120g
10-556
30mmØ - 180g
10-557
35mmØ - 260g



Collin Mallets
10-558
20cm
30mmØ - 220g



Hajek Mallets
10-559
21.5cm
27mmØ - 140g



Kirk Mallets
10-560 19cm
38mmØ - 750g
10-561 20.4cm
Head diameter
38.0mm,
Weight: 1 lb. 4 oz.
570 grams



Partsch Mallets
10-562 18cm
22mmØ - 200g



Lucae Mallets
10-563
19mmØ - 220g
10-564
25mmØ - 260g
19cm



Mallet Mallets
10-565 19cm
250mmØ - 205g
Solid steel, with
plastic faces



Cottle Mallets
10-566
18.5cm
30mmØ - 240g
1 side flat /
1 side convex



Williger Hammer
10-567 250g
10-568 350g



Neufield Hammer
10-569



**Solid Copper
Head Mallet**
10-570 16.5cm
Solid, Head
diameter
20mm



Nylon Head Mallet
10-571 19cm
Head diameter 25.4mm,
7.76 oz.
10-572 19.5cm
Head diameter 3cm
Weight 11 oz.



**Extra 3cm Nylon Face
FOR 10-572**
10-573 Head diameter
3cm



Combination Mallet
10-574 19.5cm
Solid, Head
diameter 32.0mm,
Weight 12 oz 340
grams, Head weight:
8 oz 227 grams



**Bergmann
Mallets**
10-575
24.5cm
45mmØ - 300g

MALLETS

Hammer	Martillos
Maillets	Martelli



Ombredanne Mallets
10-576
24cm
40mmØ - 550g



Heath Mallets
10-577 18cm
40mmØ - 700g
10-578 20cm
45mmØ - 1000g



Williger Mallets
10-579
28mmØ - 340g
10-580
30mmØ - 400g
24cm
Lead filled



Hajek Hammer
10-581 250gm
10-582 500gm



Universal Hammer
10-583 500gm
10-584 750gm



Mallet, Lightweight
10-585 19cm
Stainless Steel and Aluminum
Head diameter 25.0mm
Weight 7 oz 200 grams
Head Weight: 4 oz 113 grams



**Nylon Caps Left & Right
FOR 10-585 (PAIR)**
10-586
2.5cm



Mallet #49
10-587 19.5cm
Head diameter
22.0mm
Weight 7 oz 200
grams
Head Weight:
5oz/150 grams



Mead Mallet
10-588 19cm
Head diameter
26.0mm
Weight 11 oz 315
grams
Head Weight:
6 oz 170 grams



**Heath Mallet,
Heavyweight**
10-589 19cm
Head diameter
40.0mm
Weight 2 lbs.
(907 grams)
Head Weight:
20 oz (567 grams)



Orthopedic Mallet
10-590 27.5cm
Lightweight
Solid, Head
diameter 35.0mm
Weight 2 lbs.
(907 grams)
Head Weight:
1 lb. (454 grams)



Orthopedic Mallet
10-591 28cm
Heavyweight
Solid, Head
diameter 50.0mm
Head Weight:
2 lb. (900 grams)



Ortho Mallets
10-592
26.5cm
(450g)



Phenolic Handle Mallet
10-593 28 cm
Head diameter 32mm
Head weight 16 oz (454 grams)
10-594 Head diameter 45mm
Weight 11 oz (312 grams);
Head weight: 2 lbs (907 grams),



Nylon Cap
10-593
For Phenolic Handle Mallet

MALLETS

Hammer | Martillos
Maillets | Martelli



Reprocussion Free Mallet
Cap For 10-596

Reprocussion Free Mallet
10-595 28cm
Head diameter 30mm
Weight 1lb 5 oz (595 grams)
Head weight: 10 oz (283 grams)



Mallet
10-597 26cm
Plane (Nylon) convex (steel)
Head 30mm Ø
weight 675 grams.



Mallet
10-598 26cm
Head 42/30mm Ø
weight 530 grams



Mallet
10-599 26cm
Plastic Handle
head 30mm Ø
weight 510 grams



Vickers Mallets
10-600 19 cm
25mmØ - 300g
nylon disks plastic



Herbert Mallets
10-601 19 cm
25mmØ - 300g
for ulnar head
prosthesis plastic
handle



Mallet
10-602 18cm
Made of Plastic
Head 30mm Ø
weight 125 grams



Mallet
10-603 26 cm
Made of Plastic
with lead filling
Head 42mm Ø
weight 250 grams



Mallet
10-604 22.5 cm
Disks & Plastic Handle
Head 37mm Ø
weight 370 grams



MANZIM SURGICO



Mallet
26 cm
Made of Plastic
with lead filling
10-606
Head 42 mm Ø
weight 400 grams
10-607
Head 42 mm Ø
weight 250 grams



Mallet
10-608 24cm
Plastic Handle
Head 30mm Ø
weight 480
grams



Mallet
10-609



Mallet
10-610



Mallet
10-611



Mallet
10-612

Raspatorien, Stobel
Periostótomos, Pílons

Rugines-raspatoires, Punzones
Periostotomi, Pestoni

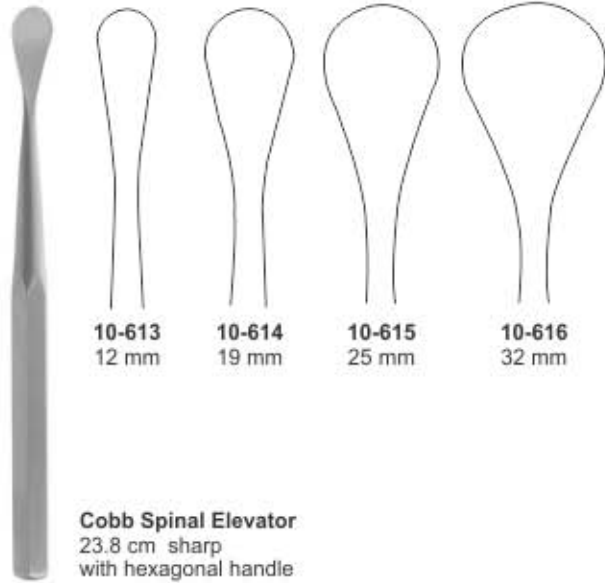

Cobb Spinal Elevator
23.8 cm sharp
with hexagonal handle



Harrington Spinal Elevator
10-617 30cm
19 mm tip width
Sharp

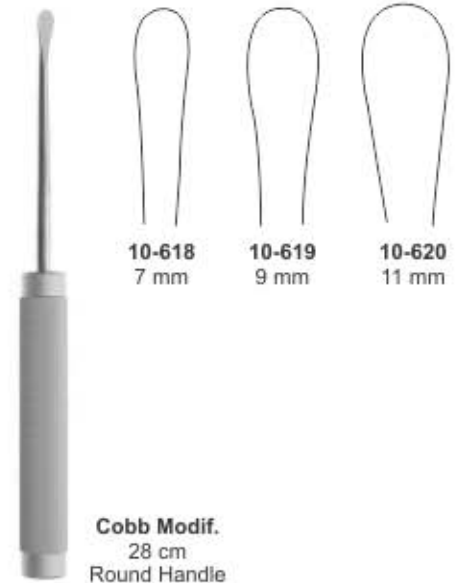

Cobb Modif.
28 cm
Round Handle

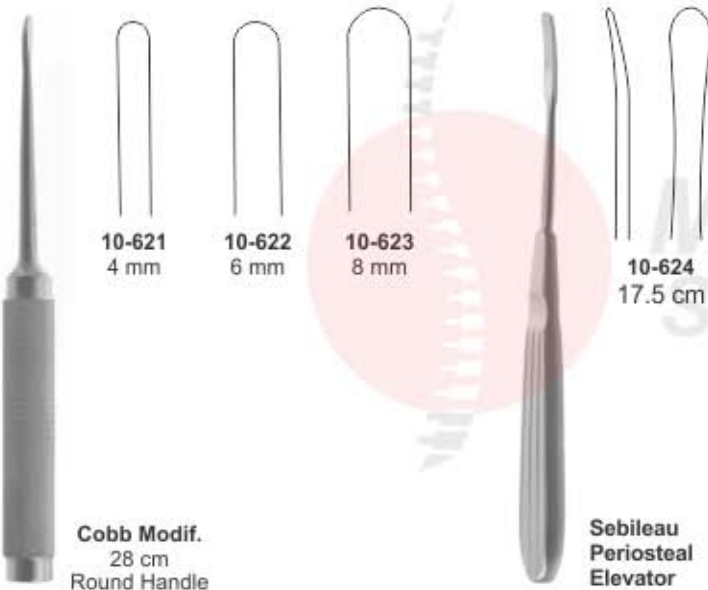

Cobb Modif.
28 cm
Round Handle



Sebileau Periosteal Elevator



Bone Tamper

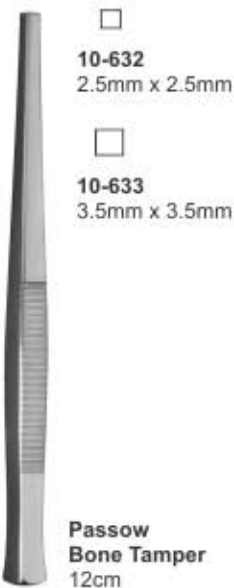

Passow Bone Tamper
12cm



Caspar Bone Tamper
20cm



Caspar Bone Tamper
20cm













Bone Tamps
10-640
15.4 cm

Scharfe Löffel
Curettes tranchantes

cucharillas cortantes
Cucchiai taglianti









Volkman Bone Curette

- | | | |
|--|---|--|
| 
10-641
17cm
0000 | 
10-642
17cm
000 | 
10-643
17cm
00 |
| 
10-644
17cm
0 | 
10-645
17cm
1 | 
10-646
17cm
2 |
| 
10-647
17cm
3 | 
10-648
17cm
4 | 
10-649
17cm
5 |
| 
10-650
17cm
6 | | |











Schede Bone Curette
17cm

- | | |
|---|--|
| 
10-651
17cm
000 | 
10-652
17cm
00 |
| 
10-653
17cm
0 | 
10-654
17cm
1 |
| 
10-655
17cm
2 | 
10-656
17cm
3 |
| 
10-657
17cm
4 | |













Bruns Bone Curette

- | | |
|---|--|
| 
10-658
17cm
000 | 
10-659
17cm
00 |
| 
10-660
17cm
0 | 
10-661
17cm
1 |
| 
10-662
17cm
2 | 
10-663
17cm
3 |
| 
10-664
17cm
4 | 
10-665
17cm
5 |
| 
10-666
17cm
6 | |



Spratt Bone Curette / Hollow Handle

- | | | |
|---|--|---|
| 
10-667
16.5cm
00000 | 
10-668
16.5cm
0000 | 
10-669
16.5cm
000 |
| 
10-670
16.5cm
00 | 
10-671
16.5cm
0 | 
10-672
16.5cm
1 |
| 
10-673
16.5cm
2 | 
10-674
16.5cm
3 | 
10-675
16.5cm
4 |
| 
10-676
16.5cm
5 | | |



Halle Bone Curette Flexible

- | |
|---|
| 
10-677
21cm
1 |
| 
10-678
21cm
2 |
| 
10-679
21cm
3 |



Uffendorde Bone Curette Left
10-680 17.5cm



Uffendorde Bone Curette Right
10-681 17.5cm

BONE CURETTES

Scharfe Löffel
Curettes tranchantes

cucharillas cortantes
Cucchiai taglienti



Bruns Bone Curette 23 cm

Fig.1
10-682

Fig.3
10-684

Fig.5
10-686

Fig.7
10-688

Fig.2
10-683

Fig.4
10-685

Fig.6
10-687

Fig.8
10-689

Fig.9
10-690



Bone Curette
Straight

10-691
20cm
000

10-693
20cm
0

10-695
20cm
2

10-697
20cm
4

10-692
20cm
00

10-694
20cm
1

10-696
20cm
3

10-698
20cm
5

10-699
20cm
6



Bone Curette
Curved

10-700
20cm
000

10-702
20cm
0

10-704
20cm
2

10-706
20cm
4

10-701
20cm
00

10-703
20cm
1

10-705
20cm
3

10-707
20cm
5

10-708
20cm
6



Schroeder Bone Curette
Sharp / rigid

10-709
30cm
1

10-711
30cm
3

10-713
30cm
5

10-710
30cm
2

10-712
30cm
4

10-714
30cm
6



Simon Bone Curette
Sharp / rigid

10-715
24cm
0000

10-719
25cm
1

10-722
25cm
4

10-716
24cm
000

10-720
25cm
2

10-723
25cm
5

10-717
24cm
00

10-721
25cm
3

10-724
25cm
6

10-718
24cm
0

BONE CURETTES

Scharfe Löffel | cucharillas cortantes
Curettes tranchantes | Cucchiali taglienti



- 10-725
3.6mm
000
- 10-726
4.4mm
00
- 10-727
5.2mm
0
- 10-728
6.8mm
1

Bone Curette
25 cm
Straight



- 10-729
2.8mm
0000
- 10-730
3.6mm
000
- 10-731
4.4mm
00
- 10-732
5.2mm
0

Daubenspeck Bone Curette
20 cm



- 10-733
Straight
- 10-734
Down Angle
- 10-735
Up Angle

Scoville Bone Curette
25 cm



- 10-736
1.8mm
00000
- 10-737
2.0mm
0000
- 10-738
2.4mm
000
- 10-739
2.6mm
00
- 10-740
2.8mm
0

Lempert Bone Curette
21.5 cm



- 10-741
5 mm
- 10-742
7 mm
- 10-743
9 mm
- 10-744
10 mm
- 10-745
12 mm

Cushing Bone Curette
23.5 cm
Pituitary Spoon,
malleable, silver-plated



- 10-746
4 mm x 10 mm
straight
- 10-747
4 mm x 10 mm
up angle
- 10-748
4 mm x 10 mm
down angle

Scoville Bone Curette
25 cm
Ruptured Disc Curette

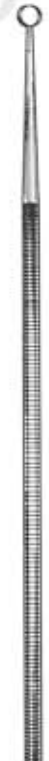

- 10-749
Ø 4 mm
straight
- 30°
10-750 Ø 3 mm
10-751 Ø 4 mm
10-752 Ø 5 mm
- 45°
10-753 Ø 3 mm
10-754 Ø 4 mm
10-755 Ø 5 mm

Tay-Bronson Bone Curette
22 cm
Pituitary Curette, double-edged

Scharfe Löffel
Curettes tranchantes

cucharillas cortantes
Cucchiai taglienti



Ray Bone Curette, 19 cm
Pituitary Curette

45°
10-756 Ø 3 mm
10-757 Ø 4 mm
10-758 Ø 5 mm

90°
10-759 Ø 3 mm
10-760 Ø 4 mm
10-761 Ø 5 mm

45° offset
10-762 Ø 3 mm
10-763 Ø 4 mm
10-764 Ø 5 mm

90° offset
10-765 Ø 3 mm
10-766 Ø 4 mm
10-767 Ø 5 mm



Volkman Curette
Oval / Oval

10-768
13cm

10-769
14cm

10-770
17cm



Volkman Curette
Round / Oval

10-771
13cm

10-772
16cm

10-773
20cm

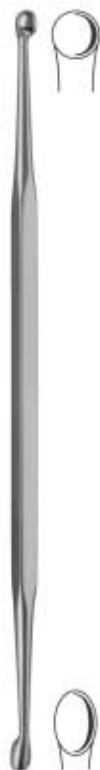

Curette
10-774
21cm
round / oval



Martini Curette
13.5cm

10-775
00
10-776
0
10-777
0
10-778
1
10-779
1
10-780
2



Martini Curette
15.5cm

10-781
00
10-782
0
10-783
1



Williger Curette
13.5cm

10-784
00
10-785
0
10-786
0
10-787
1
10-788
1
10-789
2



Williger Curette
15.5cm

10-790
00
10-791
0
10-792
1

Scharfe Löffel
Curettes tranchantes

cucharillas cortantes
Cucchiai taglienti

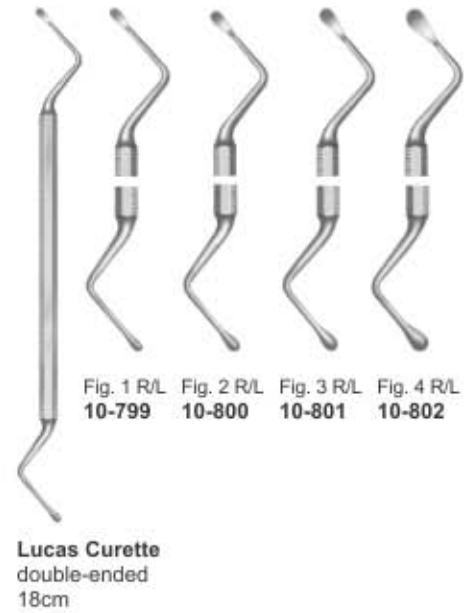

PERIOSTEAL ELEVATORS

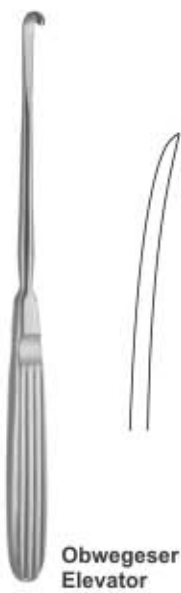

10-803
17cm
6 mm



10-804
17cm
7 mm



10-805
17cm
9 mm



10-806
17cm
11 mm



10-807
20cm
5 mm



10-808
20cm
8 mm



10-809
20cm
9 mm

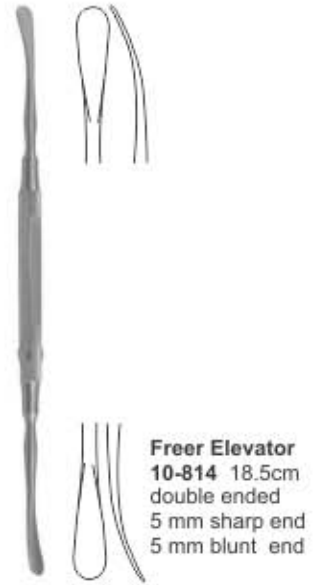

Raspatorien
Periostótomos

Rugines-raspatoires
Periostotomi

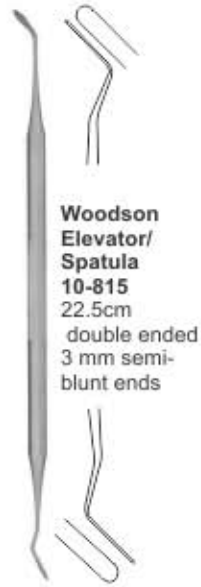

Woodson Elevator/ Spatula 10-815
22.5cm
double ended
3 mm semi-blunt ends

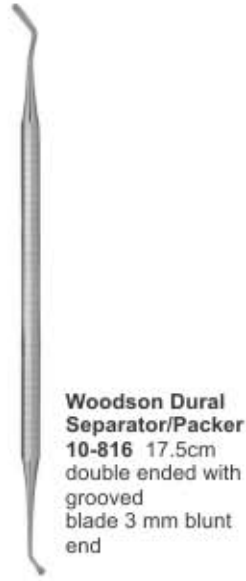

Woodson Dural Separator/Packer 10-816 17.5cm
double ended with grooved blade
3 mm blunt end

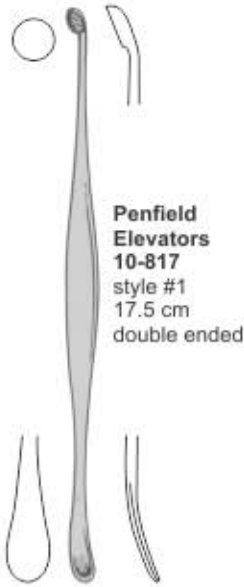

Penfield Elevators 10-817
style #1
17.5 cm
double ended

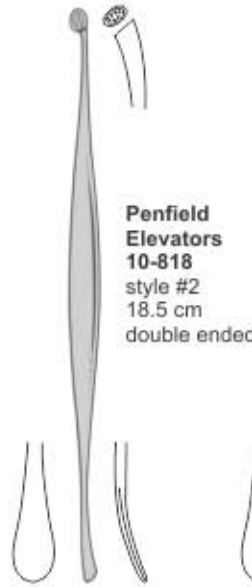

Penfield Elevators 10-818
style #2
18.5 cm
double ended

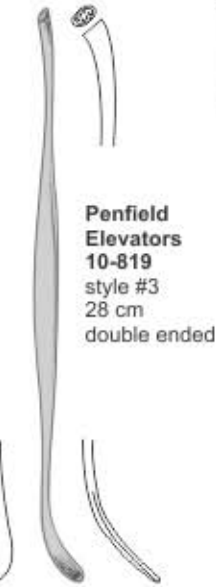

Penfield Elevators 10-819
style #3
28 cm
double ended



Penfield Elevators 10-820
style #4
28 cm
single ended



Penfield Elevators 10-821
style #5
18.5 cm
double ended



Alderdyce Elevators 10-822
21.5 cm
double ended

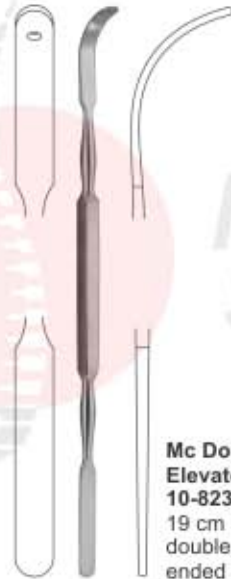

Mc Donald Elevators 10-823
19 cm
double ended

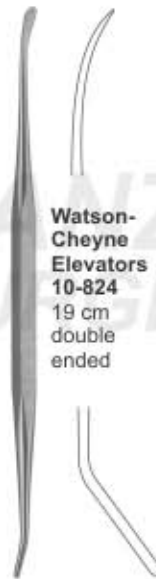

Watson-Cheyne Elevators 10-824
19 cm
double ended



Obwegeser Needle 10-825
17.5cm



Obwegeser Needle 10-826
23cm



Obwegeser Needle 10-827
18cm



Obwegeser Needle 10-828
14cm

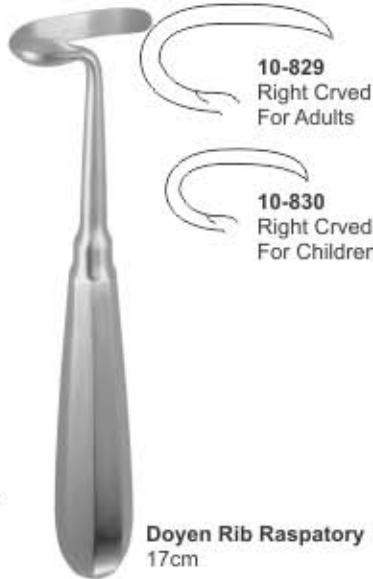

Doyen Rib Raspatory 17cm



Doyen Rib Raspatory 17cm



Sedillot Elevator 10-833
18.5cm
10-834
21cm

Raspatorien | Rugines-raspatoires
 Periostótomos | Periostotomi



Crego Periosteal Elevator 10-835
15.5cm



Williger Elevator 10-836
13cm
5mm



Williger Elevator 10-837 4mm
10-838 6mm
16cm

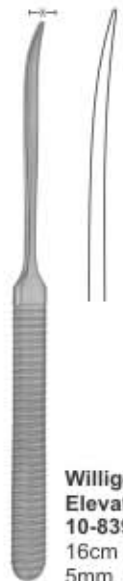

Williger Elevator 10-839
16cm
5mm



Williger Elevator 10-840
16cm
6.5mm



Farabeuf-Collin Elevator 10-841
16cm
11mm
Straight



Farabeuf-Collin Elevator 10-842
16cm
11mm
Curved



Farabeuf Elevator 10-843
15cm
Straight



Farabeuf Elevator 10-844
15cm
Curved



Lambotte Elevator 10-845 5mm
10-846 10mm
10-847 15mm
10-848 20mm
10-849 25mm
21cm Straight

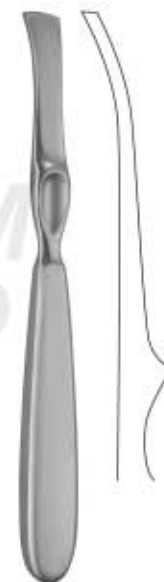

Lambotte Elevator 10-850 5mm
10-851 10mm
10-852 15mm
10-853 20mm
10-854 25mm
21cm Curved



Adson Elevator

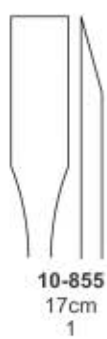

10-855
17cm
1



10-856
17cm
2

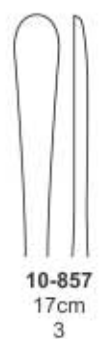

10-857
17cm
3



10-858
17cm
4



Quervain Elevator 10-859 06mm
19.5cm



Trelat Elevator 10-860 8mm
15cm

PERIOSTEAL ELEVATORS

Raspatorien | Rugines-raspatoires
Periostótomos | Periostotomi

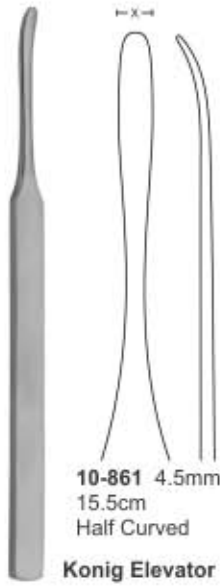

10-861 4.5mm
15.5cm
Half Curved
Konig Elevator



10-862 4.5mm
15.5cm
Full Curved



10-863
15cm
2.5mm

10-864
15cm
2.5mm

Obwegeser Elevator



Obwegeser Elevator
10-865
18.5cm



Obwegeser - Freer Osteotome Elevator
10-866
18.5cm



Howarth Periosteal Elevator
10-867
21.5cm
Sharp / Blunt



Langen-Beck Periosteal Elevator
10-868
18cm



Langen-Beck Periosteal Elevator
10-869 19cm



Alexander Periosteal Elevator
10-870 20cm



6 mm
10-871



8 mm
10-872



Semb Periosteal Elevator



10-873
17.5cm
12mm



10-874
21cm
12mm



10-875
17.5cm
12mm



10-876
21cm
13mm



10-877
22.5cm
13mm



10-878
22.5cm
15mm

Raspatorien | Rugines-raspatoires
 Periostótomos | Periostotomi

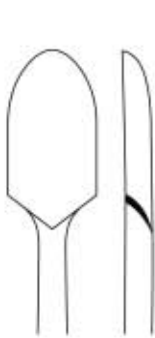

10-879
 14mm
 Straight
 1

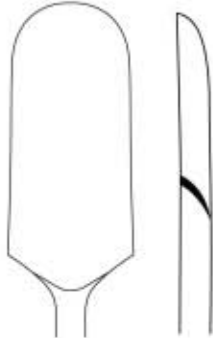

10-880
 20mm
 Straight
 3

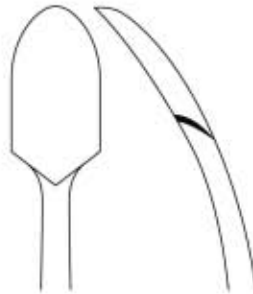

10-881
 14mm
 Curved
 2

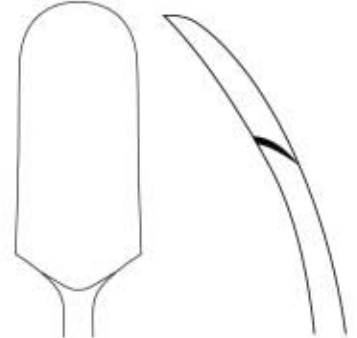

10-882
 20mm
 Curved
 3

Ferozell Periosteal Elevator
 20cm

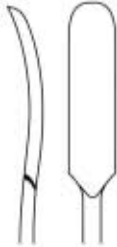

10-883
 6mm
 1



10-884
 3mm
 2



10-885
 6mm
 3

Ferozell Periosteal Elevator
 18cm



Periosteal
 Raspatories
10-886
 18.5cm
 cvd



Periosteal Elevator
10-887 18cm
 Fiber/Phenolic Handle
 blade 6mm



Hoen Periosteal Elevator
10-888
 16.5cm



Chandler Bone Elevator
10-889 19cm
 13 mm
10-890 20cm
 20 mm
10-891 23cm
 25 mm
10-892 25cm
 31 mm



Key Periosteal Elevator 19cm
10-893
 6 mm
10-894
 12 mm
10-895
 20 mm
10-896
 25 mm
 sharp,
 slightly
 curved



Pennybacker Periosteal Elevator
10-897
 6 mm
 17 cm sharp,
 curved



Langenbeck Periosteal Elevator
10-898
 15 mm
 19 cm
 sharp, slightly
 curved



Cushing Periosteal Elevator 15 mm
10-899
 Round Edge
10-900
 Square Edge
 18 cm

PERIOSTEAL ELEVATORS

Raspatorien
Periostótomos

Rugines-raspatoires
Periostotomi



Hoen Periosteal Elevator
10-901
7mm, 16cm
10-902
15mm, 19cm
10-903
20mm, 19cm
Semisharp



Sayre Periosteal Elevator
10-904 17cm
one straight blunt
and one curved
sharp



Langenbeck Periosteal Elevator
10-905 7mm
10-906 10mm
20 cm Blunt

7 mm

10 mm



Cushing Periosteal Elevator
19cm
10-907
Left
10-908
Right



Cobb Periosteal Elevator
10-909 10mm
10-910 13mm
10-911 19mm
29cm
Spinal Raspatory

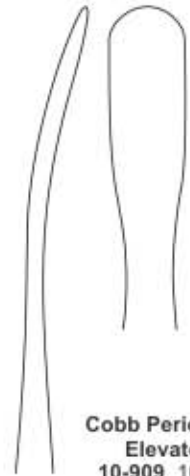

10-912
18cm
8mm



10-915
20cm
19mm

Key Periosteal Elevator



10-913
19cm
10mm

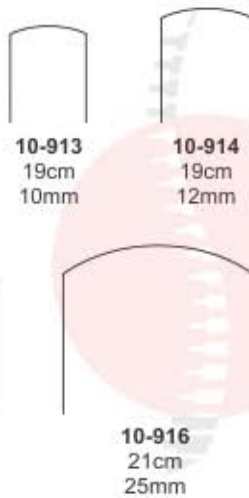

10-914
19cm
12mm

10-916
21cm
25mm



Cobb Periosteal Elevator
10-917 23.4cm
Hex Handle



Darrach Elevator
10-918 26cm
19mm
10-919 35cm
25.4mm
Blunt, Slightly
Curved



Carroll Periosteal Elevator
10-920 14cm
sharp, double ended
3 mm round end,
10 mm flat end



Langenbeck Periosteal Elevator
19.5cm
10-921
blunt edge
10-922
sharp edge



Key Periosteal Elevator sharp edge
10-923 17.7 cm 6.5 mm width
10-924 18.5 cm 9.5 mm width
10-925 18.5 cm 12.7 mm width
10-926 20.0 cm 19.0 mm width
10-927 20.9 cm 25.0 mm width



Lane Bone Elevator
10-928
16cm
Serrated



Lane Bone Elevator
10-929
27cm



Trethowan's Bone Elevator
10-930
22cm



Bristow's Bone Lever
10-931
24cm

MANZIM
SURGICO

Raspatorien, Meniskotome

Rugines-raspatoires, Bisturies para meniscos

Periostótomos, Bistouries a menisques

Periostotomi, Bisturi per menisco



**St. Thomas
10-932**
16cm
Pointed



**St. Thomas
10-933**
16cm
Rounded



**Robinson's
10-934**
17cm



**Freer D
Septum
Knife
10-935**
15cm



**Bircher
Meniscotomy
Knife
10-936**
19cm



**Matson
Meniscotomy
Knife
10-937**
22cm



**Downing
Cartilage
Knife
10-938**
25.5cm
Curved tip,
Straight shaft



**Smillie
Meniscotomy
Knife
10-939** 16cm
Straight Shaft
Blade tip width
is 7.8mm
Straight tip



**Smillie
Meniscotomy
Knife
10-940** 16cm
Curved Shaft
Blade tip width
is 7.8mm
Curved left tip



**Kanadisches
Modell
Meniscotomy
knife
10-941**
20cm



**Kanadisches
Modell
Meniscotomy
knife
10-942**
20cm

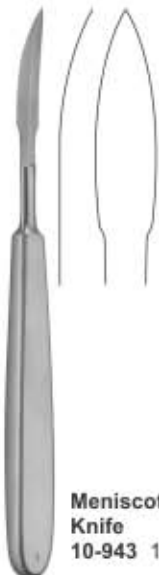

**Meniscotomy
Knife
10-943** 18cm



**Neff Meniscotomy
Knife**



10-944
22cm
left

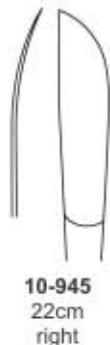

10-945
22cm
right

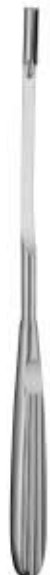

10-946
4mm

10-947
4.5mm

10-948
5.5mm

**Bunnell Tendon
Strippers**
23cm
Malleable shaft



10-949
Fig. 1
3mm

10-951
Fig. 3
5mm

**Bunnell
Tendon
Strippers**
15.2cm

10-950
Fig. 2
4mm

10-952
Fig. 4
6mm

10-953
Fig. 5
7mm



**Fischer
Tendon
Strippers**
10-954
31cm

Sehnenstripper, Knochenhebel

Instruments a ecorcher les tendons, Leviers a os

enucleadores de tendones, Elevadores para huesos

Scollatendini, Elevatori per ossa



Bunnell Tendon Strippers
10-955 23cm
Tendon passer



Kleinert-Kutz Tendon Retriever
10-956
20cm
Serrated



Kleinert-Kutz Tendon Retriever
10-957
20cm
Serrated, flexible shaft



Brand Tendon Tunelling Forceps
10-958 15cm
10-959 19cm
10-960 24cm
Straight, serrated
2 x 3 teeth



Hohmann Bone Elevator
10-961 43mm
24.5 cm



Hohmann Bone Elevator
10-962 22mm
26cm



Hohmann Bone Elevator
10-963 33mm
28cm



Hohmann Bone Elevator
10-964 24mm
26.5cm



Hohmann Bone Elevator
10-965 22mm
26cm



Capsule Retractor
10-966 25.5cm
3 sharp-pronged,
22mm width blade



Bristow-Bankart Humeral Retractor
10-967 19cm
Double-pronged,
25mm width x 102mm
depth blade



Bristow-Bankart Soft Tissue Retractor
10-968 20cm
3-pronged
21mm width blade,



Humeral Head Retractor
10-969 22cm
18mm width blade



Hohmann Bone Elevator
10-970 22cm
08mm width blade
10-971 23cm
10mm width blade



Hohmann Bone Elevator
10-972 24cm
18mm



Hohmann Bone Elevator
10-973 24cm 70mm
10-974 28.5cm 35mm width blade
10-975 33cm 40mm width blade

Knochenhebel
Leviers a os

Elevadores para huesos
Elevatori per ossa



**Hohmann Long
Shank Retractor**
10-976 23cm
43mm width blade

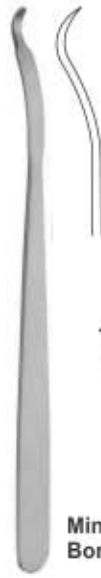

**Mini-Hohmann
Bone Elevator**

10-977 16cm
6mm width
blade



10-978 16cm
8mm width
blade



**Hohmann
Bone Lever**
10-979
15cm



**Hohmann
Bone Lever**
10-980
15.4cm
Short tip



**Hohmann
Retractor**
10-981
15cm
15mm width
blade



**Hayes Hand
Retractor**
10-982
16cm
3mm width
blade

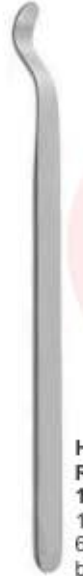

**Hayes Hand
Retractor**
10-983
15cm
6mm width
blade



Bone Lever



10-984
14cm
2.8mm



10-985
14cm
4.5mm



10-986
14cm
6mm



**Bristow Bone
Lever**
10-987
23cm



**Lane Bone
Lever**
10-988
21cm



Periosteal Elevator 17.5cm
For Metacarpals Small
10-989 6 mm width
For Metacarpals Medium
10-990 10 mm width
Light Curve, Rounded End,
10-991 5 mm width
Contra Angled Curve
10-992 4.5 mm width

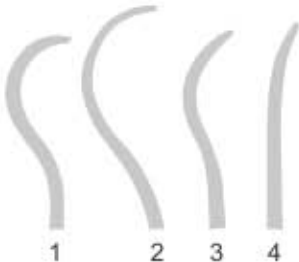

Hohmann Retractor
10-993 18cm
Small, width 6 mm
short, narrow tip



Hohmann Retractor
10-994 18cm
Small, width 8 mm
short, narrow tip



Hohmann Retractor
10-995 12.5cm
Finger Ring handle,
16mm width blade



Hohmann-Williger Retractor
10-996
16cm

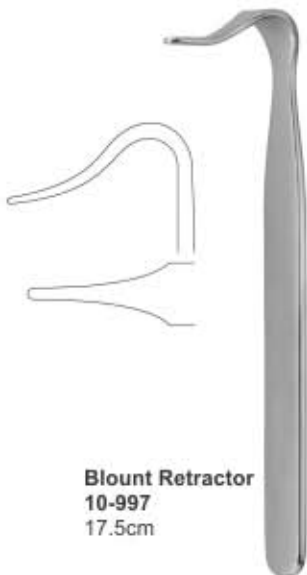

Blount Retractor
10-997
17.5cm

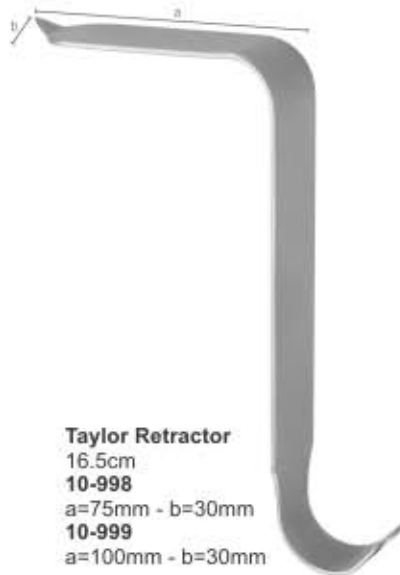

Taylor Retractor
16.5cm
10-998
a=75mm - b=30mm
10-999
a=100mm - b=30mm



Cushing Vein Retractor
10-1000 22.5cm
with fenestrated handle
Blade 12 mm
width x 10 mm



Cushing Decompression Retractor
10-1001 21.5cm
with fenestrated blade and handle
Blade 13 mm
width x 22 mm



Scoville Nerve Retractor
10-1002
24cm
7 mm
straight



Scoville Nerve Retractor
10-1003
24 cm, 7 mm
angled



Taylor Retractor
17cm
10-1004 30 x 75 mm
10-1005 30 x 100 mm



Hibbs Retractor
10-1006
25 x 75 mm, 23cm
10-1007
25 x 80 mm, 24cm



Meyerding Retractor
10-1008
16 X 50 mm, 20cm
10-1009
25 X 75 mm, 23cm
10-1010
50 X 90 mm, 24cm



Nail Extracting Forceps
10-1011
14cm



Nail Extracting Forceps
10-1012
14.5cm

Orthopädie, Sehnenstripper

Orthopédie, enucleadores de tendones

Ortopedia, Instruments a ecorcher les tendons

Ortopedia, Scollatendini



10-1014 10-1015 10-1016

Frill points only

Finger Nail Drill with 3 drill points 10-1013



Nail Splitting Forceps 10-1017 13.5cm



10-1019 Saw Blade Only for 10-1018

Ring Cutter 10-1018 17cm



10-1021 Saw Blade Only for 10-1020

Ring Cutter 10-1020 17cm



Tendon Tunelling Forceps 10-1022 13cm

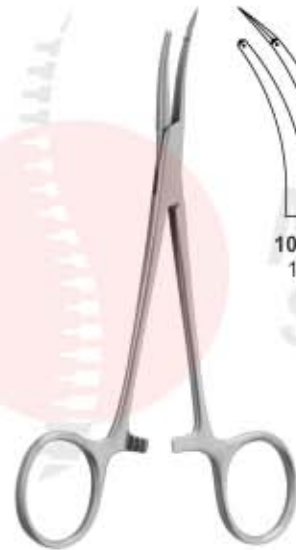

10-1023 15cm

Tendon Tunelling Forceps



10-1024 15.25cm 6 mm

Tendon Tunelling Forceps



Lead Hand 10-1025 Adult Size

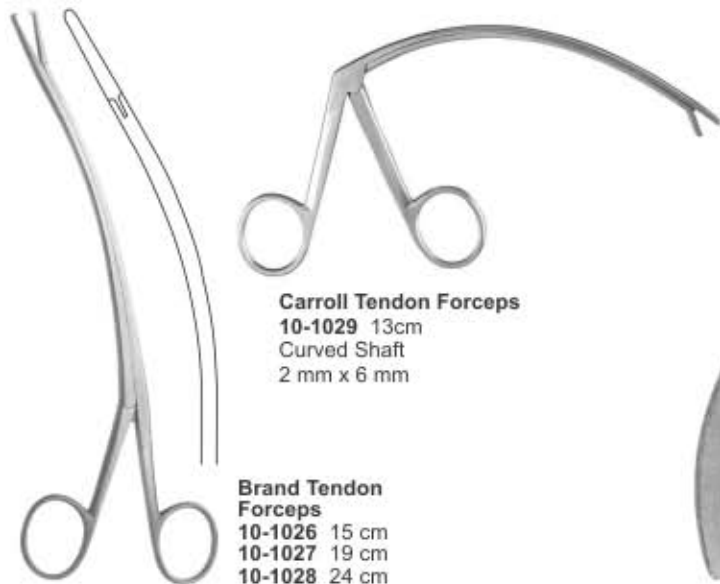

Carroll Tendon Forceps 10-1029 13cm Curved Shaft 2 mm x 6 mm

Brand Tendon Forceps 10-1026 15 cm 10-1027 19 cm 10-1028 24 cm



10-1030 14cm Cross serrated

Needle Nose Pliers



10-1031 19cm Serrated

Needle Nose Pliers



Flat Nose Plier 10-1032 18cm

Sehnenstripper, Technische Zangen

enucleadores de tendones, Pinzas tecnicas

Instruments a ecorcher les tendons, Pinces techniques

Scollatendini, Pinze tecniche



Flat Nose Pliers
10-1033 13.5cm
Broad, 4mm tip,



Flat Nose Pliers
10-1034 16.5cm
Combination plier and
cutter



Needle Nose Pliers
10-1035 13.5cm



Flat Nose Pliers
10-1036
15cm Delicate,
1.5mm tip



K-Wire Extraction Pliers
W/Screw Lock
10-1037
13cm, 3mm tip



Flat Nose
K-Wire Pliers
10-1038
14cm
10-1039
17cm



Nose Pliers
10-1040
17cm



Utility Technical
Forceps Pliers
10-1041 19cm
adjustable



Wire Bending
Forceps
10-1042 18.5cm



Flat Nose Plier
10-1043 18.5cm
parallel grip, incorporated
cutter, for hard wires up to
1.6mm

Technische Zangen | Pinzas tecnicas
Pinces techniques | Pinze tecniche



Locking Plier
10-1044 18cm
10-1045 20cm
10-1046 24cm



Plate Bending Plier
10-1047 20cm
for plates up to 2.7mm
10-1048 24cm
for plates up to 4mm



Locking Plier
10-1049 22cm
10-1050 25cm
10-1051 30cm
Locking plier, only
10-1052 30cm
with holding pins
10-1053 46cm
with extraction device



Needle-Nose Locking Pliers
10-1054



Needle-Nose Locking Pliers
10-1055



Needle-Nose Locking Pliers
10-1056



Flat Nosed Plier
10-1057 18cm
parallel, with lateral
wire cutter



Cast Spreader Model Usa
10-1058 23cm
3 Prong



Nail Extractor
10-1059 16cm
with Longitudinal Groove
(for Intramedullary Gliding Nails)

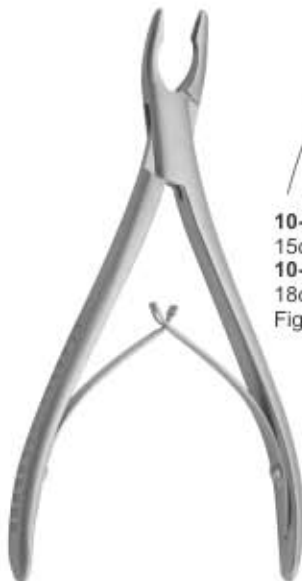

10-1060
15cm
10-1061
18cm
Fig.1

Luer Bone Rongeur
Single action
Curved, 8 x 12mm



10-1062
15cm
10-1063
18cm
Fig.2

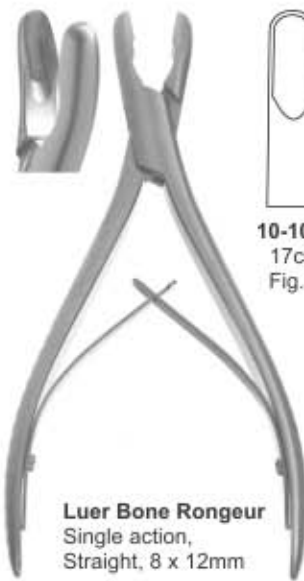

10-1064
17cm
Fig. 1

Luer Bone Rongeur
Single action,
Straight, 8 x 12mm

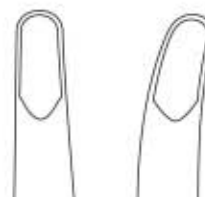

10-1065
17cm
Fig. 2



Friedmann Bone Rongeur
10-1066 14.5cm
Single action, Curved,
4 x 11mm

BONE RONGEURS

Hohlmeißelzangen
Pinzas gubias

Pinces-gouges
Pinze-sgorbie

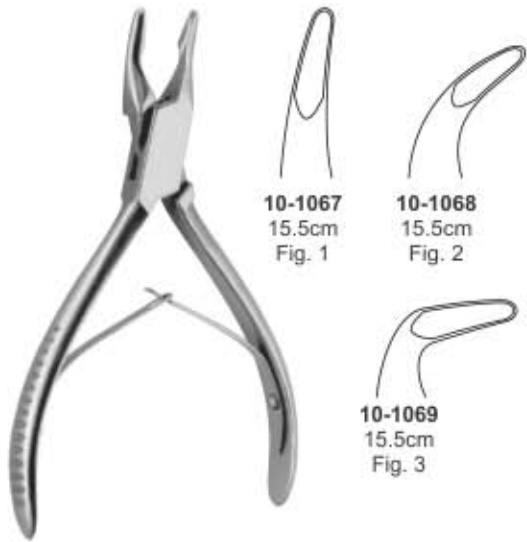

10-1067
15.5cm
Fig. 1

10-1068
15.5cm
Fig. 2

10-1069
15.5cm
Fig. 3

Blumenthal Bone Rongeur

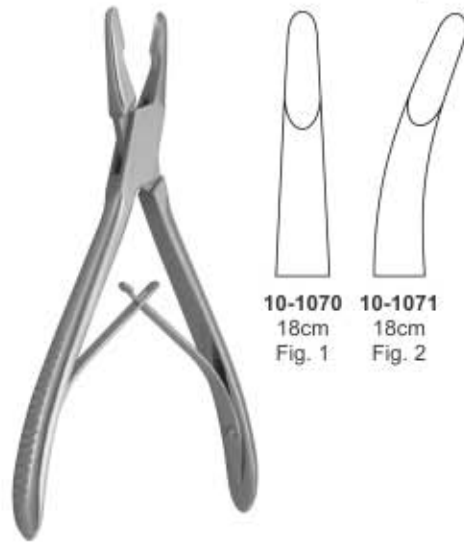

10-1070
18cm
Fig. 1

10-1071
18cm
Fig. 2

Jasen Bone Rongeur

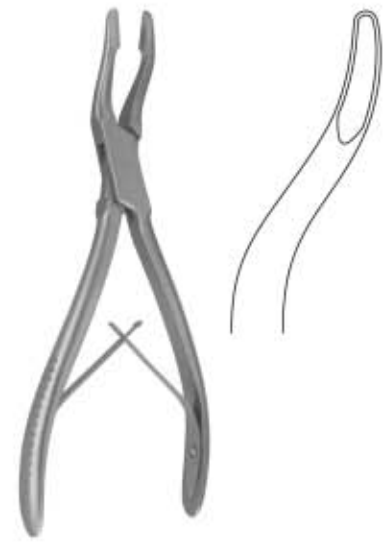

Jansen Bone Rongeur
10-1072 19cm



10-1073
17.5cm
slightly curved

10-1074
17.5cm
Strongly curved

Stellbrink Bone Rongeur

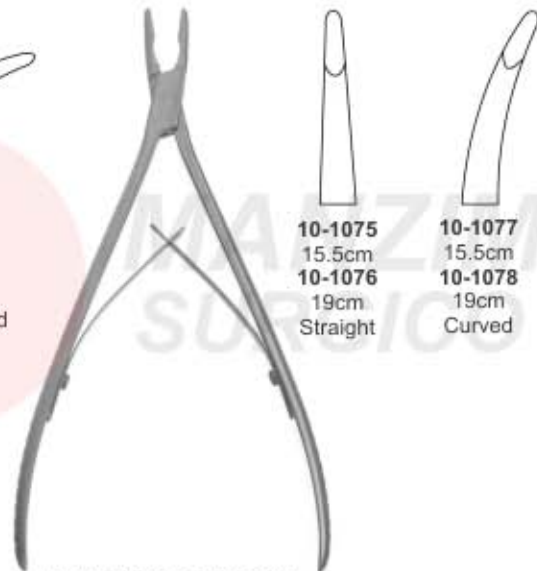

10-1075
15.5cm
10-1076
19cm
Straight

10-1077
15.5cm
10-1078
19cm
Curved

Lempert Bone Rongeur



Rongeur #4
10-1079 14cm
Rongeur #4A
10-1080 16.5cm
Single action,
Curved, 4 x 9mm



Chichirelli (Blumenthal) Rongeur
10-1081 15cm
Single action, Curved 45°,
4 x 13mm



Dean (Blumenthal) Rongeur
10-1082 15cm
Single action,
Curved 90°, 4 x 11mm



Dean Rongeur
10-1083 14.5cm
Single action
Curved, 3mm

Hohlmeißelzangen
Pinzas gubias

Pinces-gouges
Pinze-sgorbie



Hartmann Bone Rongeur
10-1084 18.5cm
Single action
Curved, 4 x 14mm

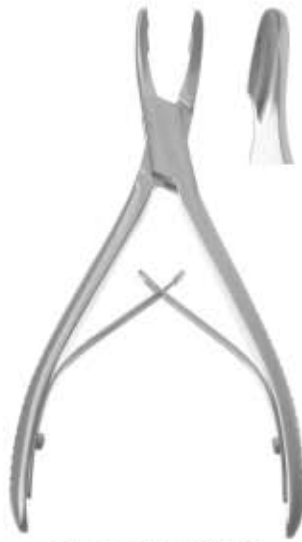

Mead Bone Rongeur
10-1085 16.5cm
Single action,
Curved, 5 x 13mm



Cleveland Bone Rongeur
10-1086 14cm
10-1087 17cm

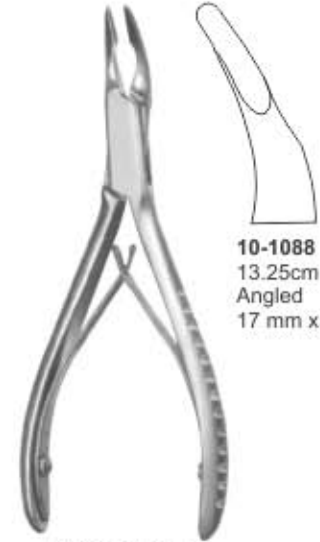

10-1088
13.25cm
Angled
17 mm x 3.5 mm



Bane Bone Rongeur



10-1089
18cm
Single action
Curved,
3 x 16mm

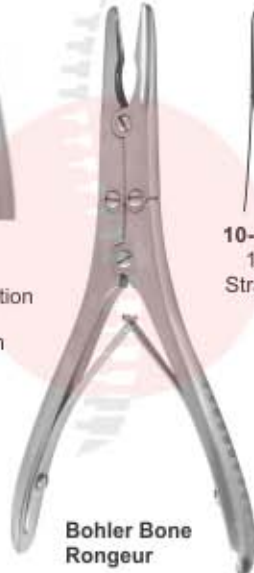

Bohler Bone Rongeur



10-1090
15c
Straight



10-1091
15cm
Curved



Zaufal-Jansen Bone Rongeur
10-1092 18cm
Double action
Curved, 5x15mm



Marquardt Bone Rongeur
10-1093 18cm



Beyer Bone Rongeur
18cm
10-1094 3 x 14mm
10-1095 4 x 15mm
Double action, Curved



Smith-Peterson Laminectomy Rongeur
10-1096 24cm
Double action,
Straight 3 x 16mm



Smith-Peterson Laminectomy Rongeur
10-1097 24cm
Double action
Curved 3 x 16mm

BONE RONGEURS

Hohlmeißelzangen
Pinzas gubias

Pinces-gouges
Pinze-sgorbie



Ruskin Rongeur
10-1100 18.5cm
Double action, 6 x 16mm,
Straight, Curved



Ruskin Rongeur
10-1101 15.5cm Straight, 3.2mm
10-1102 15cm Curved, 2 x 15mm
10-1103 15cm Curved, 3 x 15mm
Double action,



Riskin Bone Rongeur



10-1104 15.5cm
10-1105 18cm
Double action
Straight, 2 x 14mm



10-1106 15.5cm
10-1107 18cm
Double action
Curved 2 x 14mm

Ruskin Rongeur
10-1098 18cm 4x16mm
10-1099 18.5cm 5x10mm
Double action, Curved on side



Mayfield Bone Rongeur
10-1108 18cm

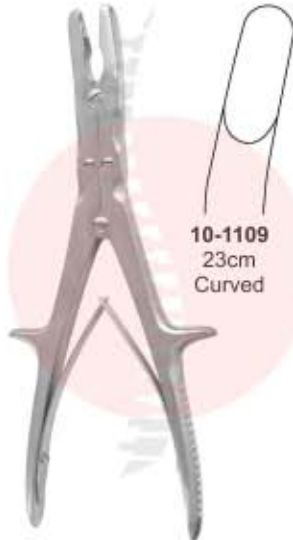

Stille-Ruskin Bone Rongeur



10-1109
23cm
Curved



10-1110
23cm
Straight



Leksell Bone Rongeur
10-1111 24.5cm 5 x 13mm
10-1112 24cm 8 x 14.5mm
Double action, Curved 50°

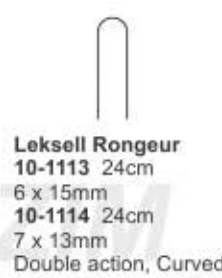

Leksell Rongeur
10-1113 24cm
6 x 15mm
10-1114 24cm
7 x 13mm
Double action, Curved



Leksell Rongeur
10-1115 24cm
3 x 18mm
Double action, Curved



Leksell Rongeur
10-1116 23cm
4 x 13mm
Double action
Fully curved



Stille Bone Rongeur



10-1117
23cm
4mm



10-1118
23cm
6mm



10-1119
23cm
8mm



Stille-Luer Rongeur Forceps



10-1120
23cm
10-1121
27cm
straight



10-1122
23cm
10-1123
27cm
curved



Echlin Duckbill Bone Rongeur 23cm



10-1124
2 x 12mm
Double action
Curved on side



10-1125
3 x 12mm
Double action
Curved on side



10-1126
4.5 x 11mm
Double action
Curved on side

Hohlmeißelzangen
Pinzas gubias

Pinces-gouges
Pinze-sgorbie

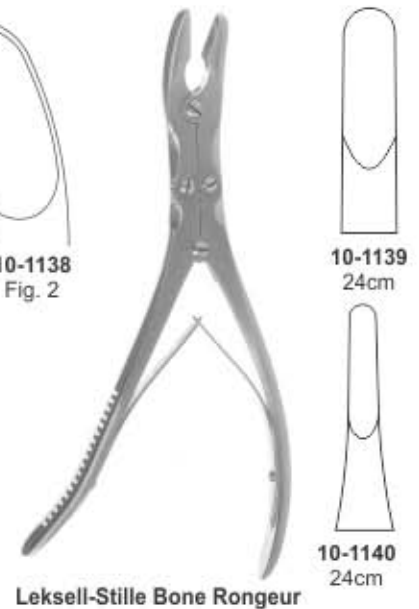
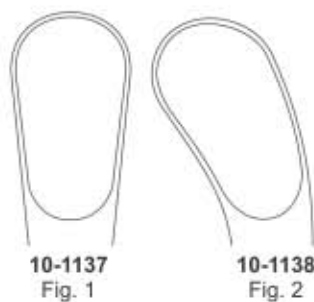

Hohlmeißelzangen
Pinzas gubias

Pinces-gouges
Pinze-sgorbie



Leksell Bonerongeur

- 10-1141 25cm 3 x 16mm
- 10-1142 23cm 5 x 16mm
- 10-1143 25cm 4.5 x 16mm
- 10-1144 25cm 6 x 16mm
- 10-1145 25cm 7 x 16mm
- 10-1146 25cm 8 x 16mm
- Double action, Curved 15°



Hakansson Bone Rongeur
10-1147 20cm



Kleinert-Kutz Bone Rongeur



10-1148
15.25cm
2 x 13 mm



Ruskin-Mini Bone Rongeur



10-1149
15.25cm
Curved
18 x 5 mm



Sybert Rongeur

- 10-1150 35.5cm 4 x 16mm
- 10-1151 35.5cm 8 x 16mm
- 10-1152 35.5cm 12 x 16mm
- 10-1153 37cm 5 x 16mm
- Double action, Angled



Cottle-Kazanjian Bone Cutting Rongeur Forceps
10-1154 19cm



Littauer / Liston Bone Cutting Rongeur Forceps



10-1155
15cm
Straight,



Cleveland Bone Cutting Rongeur Forceps



10-1156
15cm
curved



10-1157
17cm
curved



Liston Bone Cutting Rongeur Forceps



10-1158
14cm
Angled



10-1159
17cm
Angled



10-1160
19cm
Angled



10-1161
22cm
Angled

Knochensplitterzangen
Pincas cortantes a os

Pinzas cortantes para huesos
Cesoie per ossa



10-1162 14 cm
10-1163 17 cm
10-1164 19 cm
10-1165 20 cm
10-1166 22 cm
Straight

Liston Bone Cutting Rongeur Forceps



10-1167
27 cm
Straight



10-1168
27cm
Angled 45°

Stille-Liston Bone Cutting Rongeur Forceps



Semb Bone Cutting Rongeur Forceps
10-1170 24cm

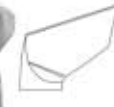

Liston Key Horsley Bone Cutting Rongeur Forceps
10-1171 27cm



Horsley Bone Cutting Rongeur Forceps 10-1172 25cm

MANZIM SURGICO



Ruskin Bone Cutting Rongeur Forceps
10-1173 20cm
Double-Action



10-1174
16cm

Cleveland-Gardner Bone Cutting Rongeur Forceps



10-1175
20cm

Markwalder Bone Cutting Rongeur Forceps

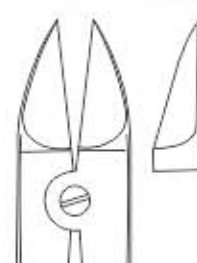

Bone Cutting Rongeur Forceps
10-1176 15cm



10-1177
15cm
Straight



10-1178
15cm
Angled

Bohler Bone Cutting Rongeur Forceps

Knochensplitterzangen
Pinces coupantes a os

Pinzas cortantes para huesos
Cesoie per ossa

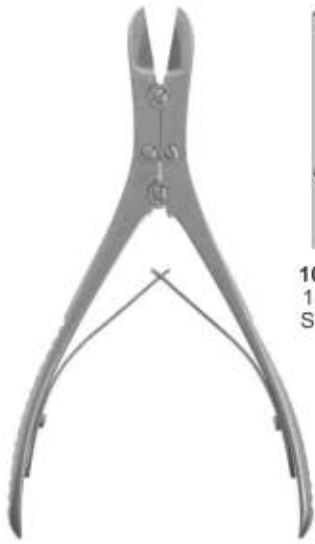

10-1179
18.5cm
Straight



10-1180
18.5cm
Angled



10-1181
15cm
Straight



10-1182
15cm
Angled



10-1183 Straight
10-1184 Curved
10-1185 Angled
19cm deicate

Ruskin-Liston Bone Cutting Rongeur Forceps

Walton-Liston Bone Cutting Rongeur Forceps

Ruskin-Liston Bone Cutting Rongeur Forceps



10-1186
17.5cm
Straight



10-1187
17.5cm
Curved

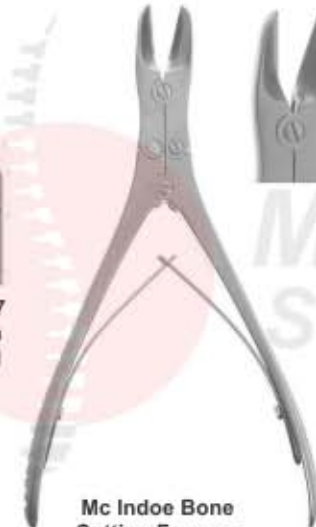

Mc Indoe Bone Cutting Rongeur Forceps
10-1188 18cm
Angled, delicate,



Kleinert-Kutz Bone Cutting Rongeur Forceps
10-1189 15cm
Straight, delicate,



Kleinert-Kutz Synovectomy Rongeur
10-1190 15cm 2 x 10mm
Double action,
Curved on side, delicate,



10-1191
27cm
Straight



Stille-Horsley Bone Cutting Rongeur Forceps
10-1192 24cm



10-1193
23cm
Angled



10-1194
27cm
Angled

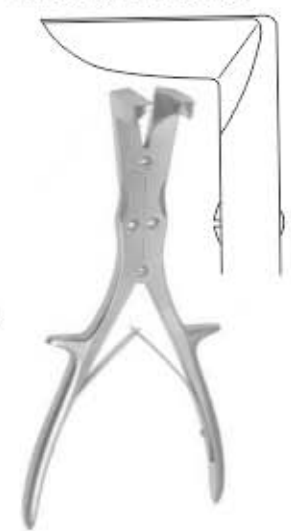

Liston-Stille Bone Cutting Rongeur Forceps
10-1195 26cm

Stille-Liston Bone Cutting Rongeur Forceps

Liston Bone Cutting Rongeur Forceps

Drahtschneidezangen
Pinces coupantes

Alicates para cortar alambre
Pinze taglia Filo

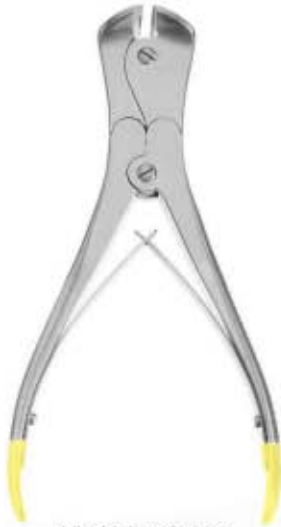

Vital Wire Cutter
10-1196 22cm
for hard wires up to 2.2mm,
for soft wires up to 3mm



Vital Wire Cutter
10-1197 22cm
for hard wires up to 2.2mm,
for soft wires up to 2.8mm



Vital Wire Cutter
10-1198 23cm
for hard wires up to 2.2mm,
for soft wires up to 3mm



Vital Wire Cutter
10-1199 18cm
for hard wires up to 1.5mm,
for soft wires up to 2mm



**Pin Puller W/
Groove TC**
10-1200 14cm



Vital Wire Cutter
10-1201 18cm
for hard wires up to 1.7mm,
for soft wires up to 2mm



Vital Wire Cutter
10-1202 15cm
for hard wires up to 1mm,
for soft wires up to 1.5mm



Vital Wire Cutter
10-1203 14.5cm
for hard wires up to 1mm,
for soft wires up to 1mm



**Cannulated Wire
/ Pin Cutter**
10-1204 19cm
Cuts wire upto 1.6 mm



Hard Wire Cutter Cuts
10-1205 26cm
for hard wires up to 3mm



**Kirschner Wires &
Steinmann
Pins Cutter**
10-1206 57cm
up to 6mm



Side Pin Cutter
10-1207
57.5cm
Side cutting w/
carbide inserts
max. cap: 5/32"



**Vital Heavy
Duty Pliers TC**
10-1208
22cm
Grip Forceps,
Combined
with cutter



**Vital Wire
Extraction
Pliers T.C**
10-1209 5mm
10-1210 7mm
18cm

Drahtschneidezangen
Pinces coupantes

Alicates para cortar alambre
Pinze taglia Filo



Side Cutter
10-1211 18.5cm
Welded carbide jaws
max capacity. 1.6mm



Delicate Wire Cutter
10-1212 12.5cm
Side cutting w/ carbide inserts
max capacity. 0.7mm



Front & Side Wire Cutter
10-1213 17cm
Front and side cutting w/ carbide inserts,
double action. Max capacity. 1.6mm



Double Action Wire Cutter
Angled, Side cutting w/
carbide inserts
10-1214 17cm
max cap 1.6mm
10-1215 21.5cm
max cap. 2.4mm



Flush Wire Cutter
10-1216 17cm
Front and side cutting w/ carbide inserts,
double action. Max capacity. 1.5mm



Wire Forceps
10-1217 17cm
Straight, serrated 5.4 mm tip



Pin Cutter Small
10-1218 26cm
Max cap: 3.2mm



Pin Cutter Medium
10-1219 36.5cm
Max cap: 4.7mm



Large Pin Cutter
10-1220 57.5cm
Large, Straight, Max.
capacity 6.3mm



Stille Plaster Shear
10-1221 37cm



**Schumacher Sternum
Shears**
10-1222 21cm

BONE HOLDING CLAMPS - BONE HOLDING FORCEPS

Knochenhalteklammern - Knochenhaltezangen | Pinzas porta huesos - Pinzas para huesos
 Daviers a os - Daviers porte-so | Tenaglie per ossa



Gerster-Lowmann Bone Clamp
 10-1223 12cm
 10-1224 14.5cm
 10-1225 18cm, 28mm
 10-1226 20cm, 35mm
 10-1227 22cm, 40mm
 1x2 Jaws



Lowmann Bone Clamp
 10-1228 12cm
 10-1229 15cm
 10-1230 17cm
 10-1231 18.5cm
 10-1232 20cm



Lambert-Lowman Bone Clamp
 10-1233 17.5cm
 10-1234 20.3cm
 2x2 Jaws

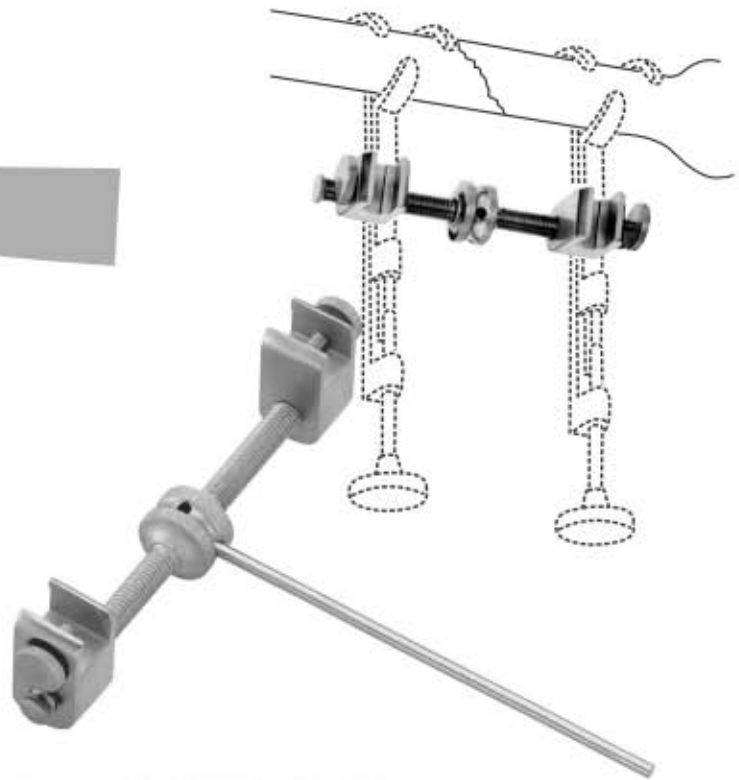

Gerster Bone Holding Clamp
 10-1235 15cm



Gerster Bone Holding Clamp
 10-1236

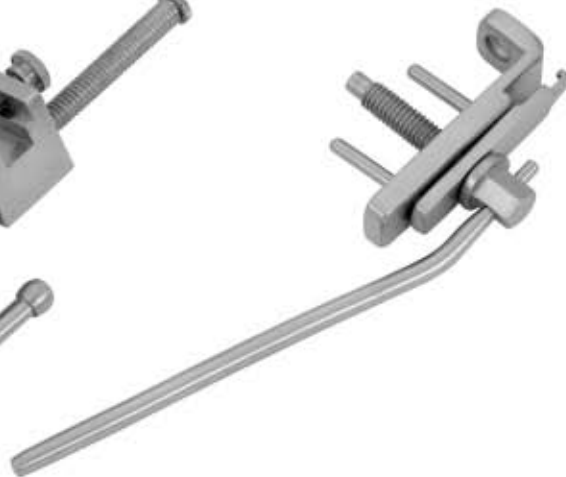

Gerster Bone Holding Clamp
 10-1237



Parham-Martin Bone Clamp
 10-1238 21cm
 Straight



Parham Martin Bands
 10-1239 19cm

Knochenhaltezaugen - Repositionszaugen
Daviers porte-so-pinces de reposition

Pinzas para huesos - pinzas para reposicion
Tenaglie per ossa - Pinze per riposizioni



Bone Reduction Forceps
10-1240 13.5cm



Locke Phalangeal Forceps
10-1241 14cm



Lewin Perforating Bone Holding Forceps

10-1242
17.5cm
serrated



Stagbeetle Bone Reduction Forceps
10-1243 Pointed tips, 13cm



10-1244
13.5cm
Angled
Serrated

Bone Reduction Orthopedic Forceps



Shoulder Percussion Awl
Pointed, 21.6cm
10-1245 Small
10-1246 Medium
10-1247 Large
10-1248 Pointed, 23.5cm



Meniscus Clamp
10-1249 13.5cm
Serrated



Meniscus Clamp
10-1250 13.5cm
Angled 20°, serrated



Preston Logamentum Flavum Forceps
10-1251 19cm
Curved, 1 x 2 teeth



Meniscus Clamp
10-1252 18cm
Straight, Curved shaft



Dingman Bone Clamp
10-1253 19cm
Straight, Serrated,
1 1/2" tip length, Curved shaft



Fergusson Bone Holding Forceps
10-1254 21cm 2 x 2 teeth

Knochenhaltezaugen
Daviers porte-so

Pinzas para huesos
Tenaglie per ossa



10-1255
23cm

Van Buren Sequestrum Forceps
Curved on side, serrated



Langenbeck Bone Holding Forceps
10-1256 21cm



Semb Bone Holding Forceps
10-1257 19cm without ratchet
curved sideways deep teeth



Semb Bone Holding Forceps
10-1258 20.3cm, with ratchet
curved sideways deep teeth



10-1259
17.8cm
10-1260
20cm
10-1261
23cm
straight

Sequestrum (Nircosis) Bone Holding Forceps

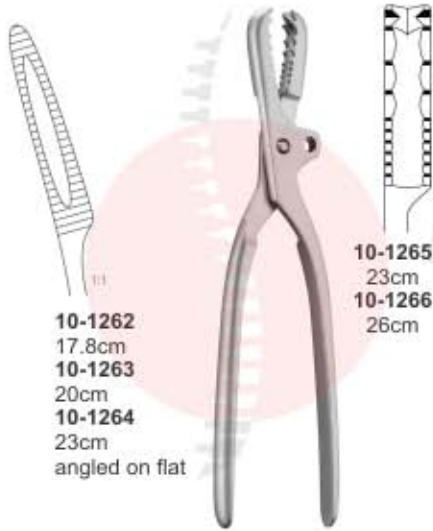

10-1262
17.8cm
10-1263
20cm
10-1264
23cm
angled on flat

Farabeuf Bone Holding Forceps with adjustable jaw



10-1267
26cm

Farabeuf-Lambotte Bone Holding Forceps with adjustable jaw

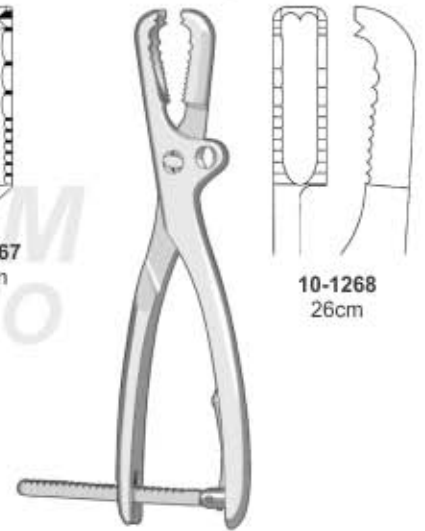

10-1268
26cm

Farabeuf-Lambotte Bone Holding Forceps with adjustable jaw



Bishop Bone Clamp
10-1269 22.5cm
Straight



Kern Bone Holding Forceps
10-1270 17cm
10-1271 24cm
without ratchet



Kern Bone Holding Forceps
10-1272 17cm
10-1273 24cm
with ratchet



Hey Groves Bone Holding Forceps

10-1274
21cm
10-1275
27cm
10-1276
30cm

BONE HOLDING FORCEPS

Knochenhalte-zangen
Daviers porte-so

Pinzas para huesos
Tenaglie per ossa



- 10-1277**
33cm 11 mm tip W/ Ratchet
- 10-1278**
33cm 13 mm tip W/ Ratchet
- 10-1279**
43cm 13.5 mm tip W/ Ratchet
- 10-1280**
13cm 10 mm tip W/o Ratchet

Lane Bone Holding Forceps
Light Model



Lane Bone Holding Forceps
10-1281 33cm 13 mm tip
10-1282 43cm 12 mm tip
without ratchet



Ulrich Bone Holding Self Retaining Forceps

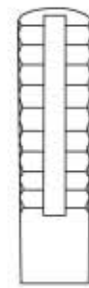

- 10-1283** 18 cm mini
- 10-1284** 22 cm
- 10-1285** 26 cm
- 10-1286** 28 cm
- Straight with speed lock



Ulrich Bone Holding Forceps



- 10-1287** 18cm
- 10-1288** 22cm
- 10-1289** 26cm
- 10-1290** 28cm
- Angular, with speed lock



Ulrich Bone Holding Forceps
Angular With Speed Lock
& swivel jaw



- 10-1291**
28cm



- 10-1292**
22cm
- 10-1293**
27cm
- 10-1294**
30cm

Lambotte Bone Holding Forceps
One Jaw Mobile
adjustable jaw



Lane Bone Holding Forceps
10-1295 31.5cm
10-1296 39cm



- 10-1297**
15 cm, 2.5mm
- 10-1298**
19 cm, 6.5mm
- 10-1299**
24 cm, 9.5mm
- 10-1300**
26 cm, 10mm
- 10-1301**
28 cm, 11mm

Lambotte Bone Holding Forceps
Self-Centering, with speed lock



Subacromion Spreader
10-1302 26.75cm Right
10-1303 26.75cm Left



Bone Reduction Forceps
10-1304 14cm
Serrated with pointed tips

*Knochenhaltezaugen
Daviers porte-so*

*Pinzas para huesos
Tenaglie per ossa*



Bone Reduction Forceps
10-1305 14cm Curved
10-1306 15cm Serrated



10-1307
14cm Serrated
10-1308
14cm Curved
10-1309
17cm Curved

**Bone Reduction Forceps,
Pointed Tips**



Semb Bone Holding Forceps
Curved on side
10-1310 19cm 4 x 5 teeth
10-1311 21cm 5 x 5 teeth



**Martin Cartilage Bone Holding
Clamp Forceps**
10-1312 19 cm Str.

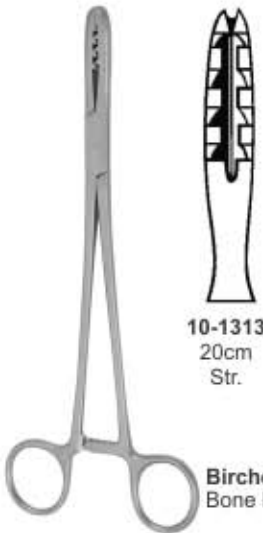

10-1313
20cm
Str.

**Bircher-Ganske
Bone Holding Forceps**



10-1314
20cm
Cvd.



10-1315
17.5cm
5.0mm

10-1316
25cm
9.5mm

10-1317
26cm
10.5mm

10-1318
27cm
12.0mm

**Verbrugge Bone
Holding Forceps**

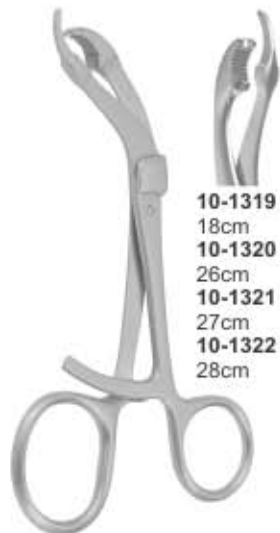

10-1319
18cm
10-1320
26cm
10-1321
27cm
10-1322
28cm

**Verbrugge Bone
Holding Forceps
W/ Long Ratchet**



10-1323
17.2cm

**Verbrugge Bone Holding
Forceps
with short ratchet**



10-1324 15 cm
10-1325 19 cm
10-1326 24 cm
10-1327 26 cm
10-1328 29 cm

**Verbrugge Self-Centering
Bone Holding Forceps
with long ratchet**



**Lane Bone Plate Holding
Forceps**
10-1329 22cm

BONE HOLDING FORCEPS

Knochenhaltezaugen
Daviers porte-so

Pinzas para huesos
Tenaglie per ossa



Verbrugge Bone Holding Forceps
10-1330 18cm



Verbrugge Bone Holding Forceps
10-1331 18cm



10-1332
25cm
10-1333
26cm
10-1334
27cm

Verbrugge Bone Holding Forceps



10-1335
25cm
10-1336
26cm
10-1337
27cm

Verbrugge Bone Holding Forceps



Verbrugge Bone Holding Forceps
10-1338 18cm

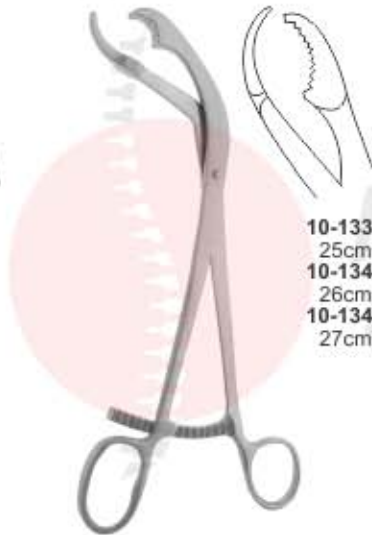

10-1339
25cm
10-1340
26cm
10-1341
27cm

Verbrugge Bone Holding Forceps



Bone Reduction Forceps
10-1342 13.5cm



Reill Bone Reduction Forceps
10-1343 17cm
Curved, pointed tips



Bone Reduction Forceps
10-1344 20.4cm
Pointed tips



Bone Reduction Forceps
10-1345 13.5cm
for maxillary reposition



Haase
10-1346 16.5cm
for mandibular fractures



10-1347
9.5cm

10-1348
9.5cm

Bone Holding forceps

Knochenhaltezaugen
Daviers porte-so

Pinzas para huesos
Tenaglie per ossa



Fibula Bone Holding Forceps
10-1349 22cm



Glenoid Perforating Forceps
10-1350 17cm
Lightly curved, pointed tips
Strongly curved, pointed tips



Reil Bone Holding Forceps
10-1351 17cm



Bone Reduction Forceps
10-1352 20cm
with Points



Pelvic Reduction Forceps Asymmetric
10-1353 40cm



Malleolar Bone Holding Forceps
10-1354 21cm
Straight, 1 x 1 teeth



Patella Malleolar Forceps
10-1355 21cm



Reduction Forceps with Thread Lock

10-1356 16cm
10-1357 24cm



Reposition Forceps
10-1358 23cm



Pelvic Reposition Forceps
10-1359 19cm
10-1360 23cm



Pelvic Reposition Forceps
10-1361 25cm



Pelvic Reposition Forceps
10-1362 25cm
3 Balls Spikes



Pelvic Reduction Forceps Asymmetric with 3 ball Spikes

10-1363 25cm



Pelvic Reduction Forceps Asymmetric
10-1364 25cm



Pelvic Reposition Forceps
10-1365 40cm



Pelvic Reposition Forceps
10-1366 40cm

Handbohrapparate
Perforateurs a main

Perforadores de mano
Perforatori a mano



Bunnell Drill
10-1367 16cm
Opening up to 4mm
10-1368 spare key
light metal housing
longitudinally cannulated



Ralk Drill
10-1369 16cm
Opening up to 6.35mm
light metal housing
longitudinally cannulated



Plaster Saw Electronic Power
Volt #110
10-1370
Volt #220
10-1371

10-1373
Spare Blade



Moore Drill And Bit Set Complete
10-1374



Fig. 1 10-1376 2.5mm
Fig. 2 10-1377 3.0mm
Fig. 3 10-1378 3.5mm
Fig. 4 10-1379 4.0mm
Fig. 5 10-1380 5.0mm
Fig. 6 10-1381 8.0mm
Fig. 7 10-1382 12.0mm
Fig. 8 10-1383 16.0mm
Fig. 09 10-1384
Fig. 10 10-1385 1.0mm
Fig. 11 10-1386 1.5mm
Fig. 12 10-1387 2.0mm

Stille Pattern Drill Set
10-1375
Complete set of stainless
drill bits and burs

Handbohrapparate
Perforateurs a main

Perforadores de mano
Perforatori a mano



10-1388
Hudson Brace 26.7cm
with standard thumb screw chuck

- C 10-1390 Hudson Bur, 9mm Diameter
- D 10-1391 Hudson Bur, 14mm Diameter
- E 10-1392 Hudson Bur, 16mm Diameter
- F 10-1393 Hudson Bur, 22mm Diameter
- G 10-1394 Cushing Perforator, for Hudson Brace
- H 10-1395 Hudson Cerabellar Extension, 4" for Hudson Brace
- I 10-1396 McKenzie Perforator for Hudson Brace

10-1389
Hudson Brace 27.9cm
with Improved Snap-Lock chuck



Jacobs
10-1397 28cm
opening up to 6.35mm



Hand Drill
10-1398
opening up
to 6.35mm



T-Handle
10-1399
AO Coupling



Jacob's Chuck
10-1400 T-Handle and key
10-1401 only
10-1402 Key



Key Handle
10-1403



T-Handle
10-1404
for AO Coupling



Memoral Head Extractor
10-1405

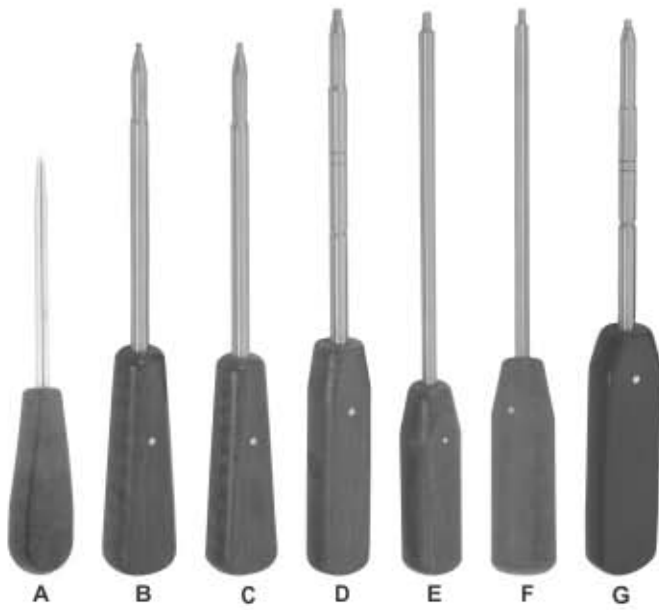

HEXAGONAL HEAD

	Size of screws	Head Size	Fiber-Handle	AO Coupling	Dental Coupling
A	1.5mm	1.5mm	10-1406	10-1409	10-1412
B	2.0mm				
C	2.7mm	2.5mm	10-1407	10-1410	
D	3.5mm				
E	4.0mm				
F	4.5mm	3.5mm	10-1408	10-1411	
G	6.5mm				



Parallel Target Device
10-1413
for guide wires 2mm



Mortising Chisel
10-1414



Wire Guide
10-1415
45mm



Wire Guide
10-1416
70mm



Countersink
10-1417



Countersink
10-1418



Countersink
10-1419



Perthes
10-1420 18cm
10-1421 21cm



10-1422
14cm



10-1423
14cm



Mini Drill Sleeve
10-1424
1.1 mm and 1.5 mm drill bits
10-1425
1.5 mm and 2.0 mm drill bits



Drill Guide
10-1426
drill sleeve for 2.0 mm drill bit



10-1427 Tap Sleeve, 2.0 mm ø
10-1428 Drill Sleeve, 2.7 mm ø
10-1429 Tap Sleeve, 2.5 mm ø
10-1430 Drill Sleeve, 3.5 mm ø



Neutral & Load Drill Guide
10-1431 1.5 mm for 2.0 mm Screws
10-1432 2.0 mm for 2.7 mm Screws
10-1433 2.5 mm for 3.5 mm Screws
10-1434 3.2 mm for 4.5 mm Screws



Tap Sleeve
10-1435
 3.5 mm



Tap Sleeve
10-1436
 3.5 mm also for used
 as 3.2 mm drill Guide



Tap Sleeve
10-1437
 4.5 mm



Drill Sleeve
10-1438 3.2 mm
 for Round Hole Plates



Drill Guide
10-1439 4.5 mm Screws
 Drill Bit 4.5 mm & 3.2 mm



Drill Guide
10-1440 6.5 mm Screws
 Drill Bit 3.2 mm



Drill Guide
10-1441 3.5 mm for neutral and
 compression Positioning Drill Bit 2.5 mm



C - Clamp
10-1442
 Drill Guide with thread
 for Drill Bit 4.5 mm



Insert Drill Sleeve
10-1443 2.7 / 2.0 mm Drill Bit 2.0 mm
10-1444 3.5 / 2.5 mm Drill Bit 2.5 mm
10-1445 4.5 / 3.2 mm Drill Bit 3.2 mm



Drill Small Pointed
10-1446 Drill Bit 3.5 mm



Drill Pointed Guide
10-1447 6.5 mm



Drill Pointed Guide
10-1448 6.5 mm

Plattenbiegevorrichtungen

Dispositivos de doblado de placas

Dispositifs de cintrage de plaques

Dispositivi di piegatura della piastra



Bending Device
10-1449
21.5cm
to bend straight
and angled plates



Bending Device
10-1450
21.5cm
to bend straight
and angled plates



Rod Bender
10-1451
to bend straight
and angled



Universal Rod Bender
10-1452 28.5cm
to bend straight
and angled



Rod Bender
10-1453
to bend straight
and angled



Slotted Hammer
10-1454 14mm



Plate Bender
10-1455



Plate Bender
10-1456



Plate Bender
10-1457



Plate Bender
10-1458



Plate Bender
10-1459



Plate Bender
10-1460



Plate Bender
10-1461

*Extensionsbugel
Etriers pour extension*

*Estribos para extension
Archi per estensione*



10-1462 18cm
Wire strainer for
kirschner wires



Kirschner Extension Bows
10-1463 x=95mm y=70mm
10-1464 x=100mm y=100mm
10-1465 x=120mm y=120mm
10-1466 x=155mm y=155mm
10-1467 x=200mm y=155mm
 with 3 traction hooks



Kirschner Extension Bows
10-1468 x=130mm
10-1469 x=185mm
10-1470 x=220mm
 with 3 traction hooks



**Wrench
Kirschner
Extension Bows
10-1471
14mm/17mm**

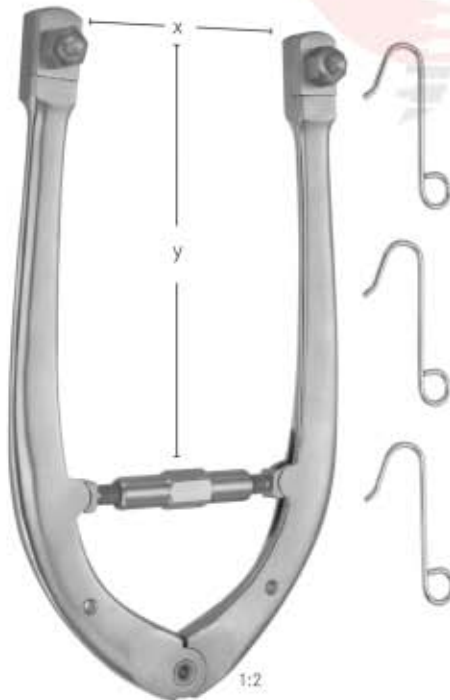

Kirschner Extension Bows
10-1472 x=180mm y=100mm
10-1473 x=270mm y=160mm
 with 3 traction hooks



Bohler Kirschner Extension Bows
10-1474 x=75mm y=90mm
10-1475 x=90mm y=160mm
10-1476 x=110mm y=210mm
10-1477 x=150mm y=210mm
 with 3 traction hooks



**Charnley-mueller
10-1478
Compression Clamp**



Screw Depth Gauges

- 10-1479 Mini Gauge, Longmeasures up to 30mm
- 10-1480 Small Gauge, Longmeasures up to 50mm
- 10-1481 Large Gauge, Longmeasures up to 100mm
- 10-1482 X-Large Gauge, Longmeasures up to 120mm



Screw Depth Gauges

- 10-1483 Mini Gauge, Longmeasures up to 30mm
- 10-1484 Small Gauge, Longmeasures up to 50mm
- 10-1485 Large Gauge, Longmeasures up to 100mm
- 10-1486 X-Large Gauge, Longmeasures up to 120mm

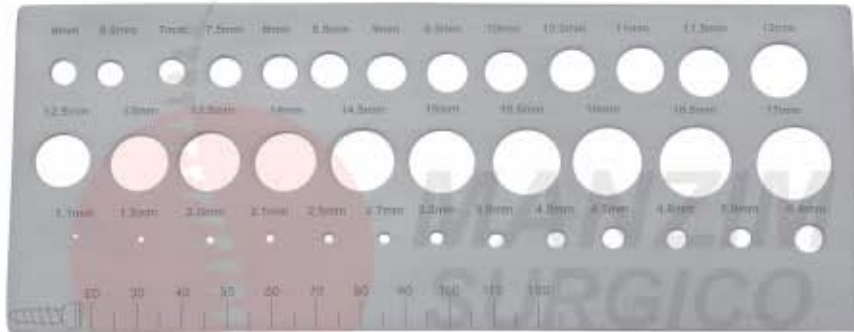

Measuring Gauge
10-1487
for nail

10-1488 Tri Angular Positioning Plate

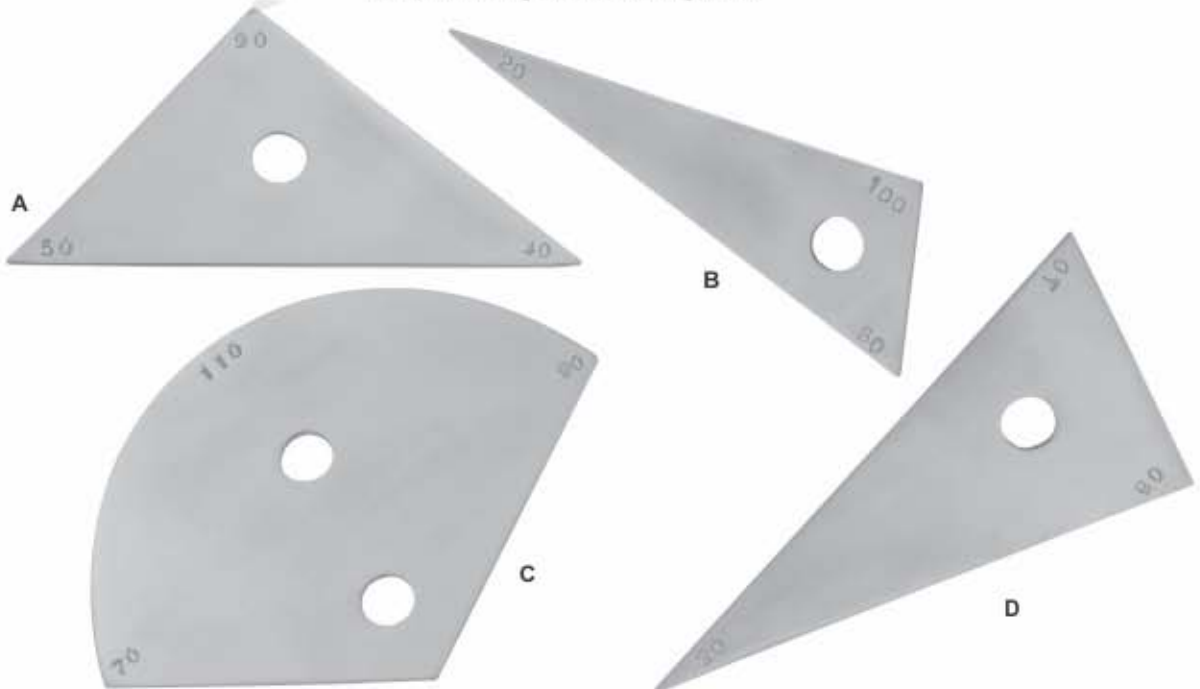

NEUROSURGERY INSTRUMENTS





Hubson, Brace Hand Drill
11-004 27cm
complete with 4 twist drills
(Fig. 1 - Fig. 4) and extension piece

GALT
11-001 Ø 12,5 mm
11-002 Ø 16 mm
11-003 Ø 19 mm

Hudson Brace
11-005
28cm with Improved
Snap-Lock chuck



Huson Hand
drill bit
Fig.1
11-006
9mm

Huson Hand
drill bit
Fig.2
11-007
14mm

Huson Hand
drill bit
Fig.3
11-008
16mm

Huson Hand
drill bit
Fig.4
11-009
22mm

Cushing
Hand drill bit
11-010
14mm

Hudson
Cerabellar
Extension
10cm
11-011
Hudson Brace

McKenzie
Hand drill bit
11-012
13mm

Schadelhalter

Pinzas de traccion cranial

Pinces de traction Cranienne

Pinze per trazione craniale

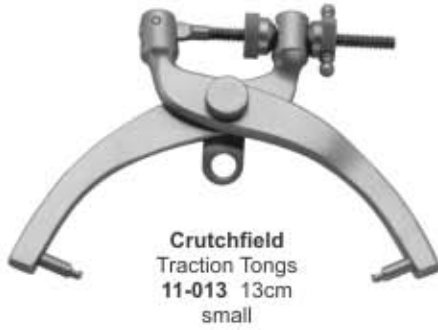

**Crutchfield
Traction Tongs
11-013 13cm
small**



11-015

**Crutchfield drill bit
3.5mm**

**Crutchfield drill bit
5mm**

**Set of 2 Pieces for
11-013 and 11-014**



**Crutchfield
Traction Tongs
11-014 18.5cm**



**11-015
Wrench double-ended for**



**Crutchfield Skull
11-016**
large type, cervical traction tongs -
pins adjustable no drilling to be done
11cm

MANZIM
SURGICO



**Cloward Vertebral Cervical
Spreader
11-017**



**Spinal Distractor
11-018 24cm
45° angle / small style
6mm rods**



**Spinal Distractor
11-019 25.5cm
small style**



**Inge Retractor
11-020 20.5cm
toothed w/spindle**

Wundhaken | Ecarteurs
Separadores | Divaricatori



Supra Cut Distraction Screw
11-021 12mm Non Sterile
11-022 14mm Non Sterile
11-023 16mm Non Sterile
11-024 18mm Non Sterile
11-025 12mm Sterile
11-026 14mm Sterile
11-027 16mm Sterile
11-028 18mm Sterile



Supra Cut Distraction Screw Driver
11-029



Cloward Retractor
11-030 15.5 cm



Cloward Retractor
11-031 13.5 cm

MANZIM
SURGICO



Inge
11-032
Lamina Spreader
16 cm

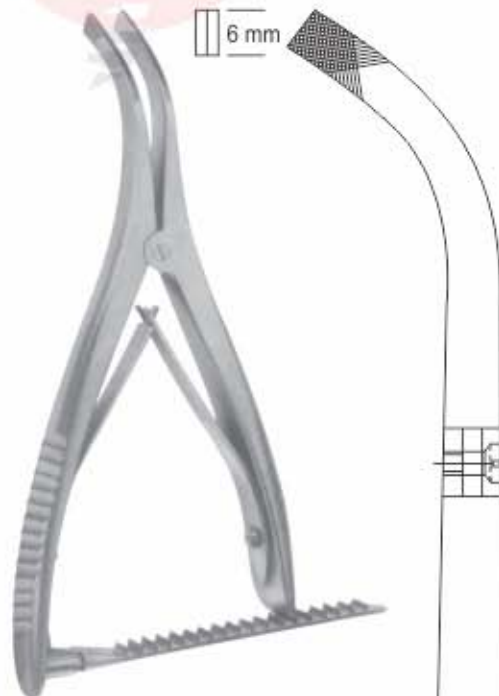

Inge Retractor
11-033 17 cm

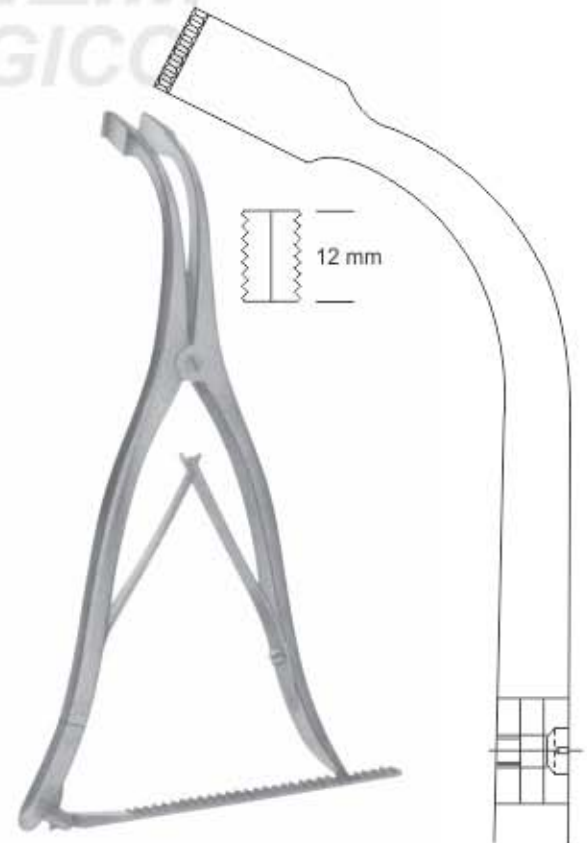

Inge Retractor
11-034 27.5 cm

Instrumente zur Schädelöffnung
Instruments pour l'ouverture de crâne

Instrumentos para apertura craneana
Strumenti per l'apertura del cranio



De Martel
 Saw Conductor
11-035 33cm



Adson
 Drill guide
11-036
 15cm



De Vilbiss
 Skull Forceps
11-037
 20cm



Dahlgren
11-038
 Cranial Rongeur
 20 cm



Gigle-Strully
 Handle for
 wire saw
11-039

MANZIM
 SURGICO



Olivecrona
 Wire Saw
11-040 30cm
11-041 40cm
11-042 50cm
11-043 60cm
11-044 70cm

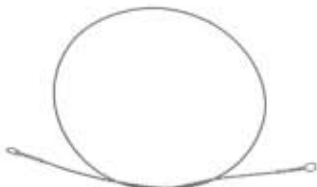

Gigle, Wire Saw
11-045 30cm
11-046 40cm
11-047 50cm
 6 wires twisted



Bailey-Gigli
11-048
 Saw Guide 30.5cm
 flexible



Davis
11-049
 Guide for Gigli Saws,
 20cm

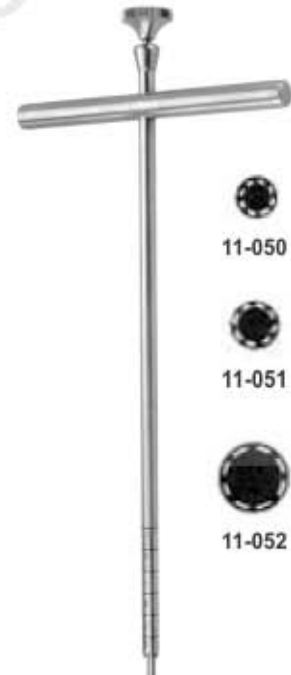

Michele Trephine,
11-050 16cm shaft, 0.47cm
 O.D graduated 0.64cm To 3.2cm
11-051 16cm shaft, 0.79cm
 O.D graduated 0.64cm To 3.2cm
11-052 16cm shaft, 0.56cm
 O.D graduated 0.64cm To 3.2cm

selbsthaltender Hirnretractor
Retracteur cerebrale autostatique

Separador cerebral autostatico
Retrattore cerebrale autostatico



11-053
wire cable only



11-054
Support only,
flat brain spatulas,



11-055
Support only,
for brain spatulas
with round shaft
up to 5.5 mm diam.
Fixing for flexible



Riechert
11-056
Fixation base, for skull
mounting, holding 1
flexible arms



Riechert
11-057
Fixation base, for skull
mounting, holding 2
flexible arms



11-058
Fixation base, for skull
mounting, holding 1
flexible arms

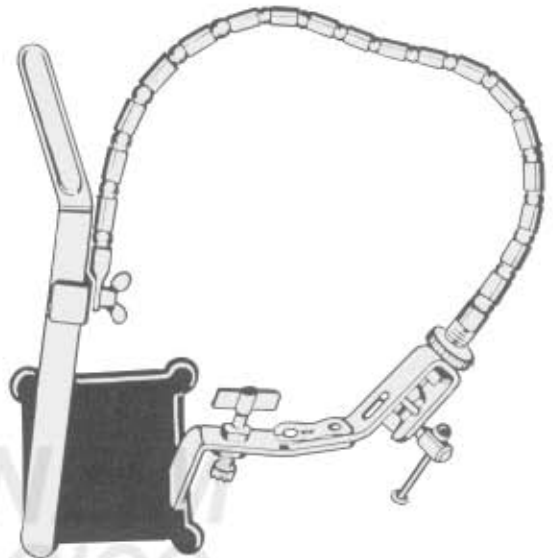

Leyla
Self-Retaining Brain
Retractor
with 1 flexible arm, complete consisting of
11-059
11-060
11-061

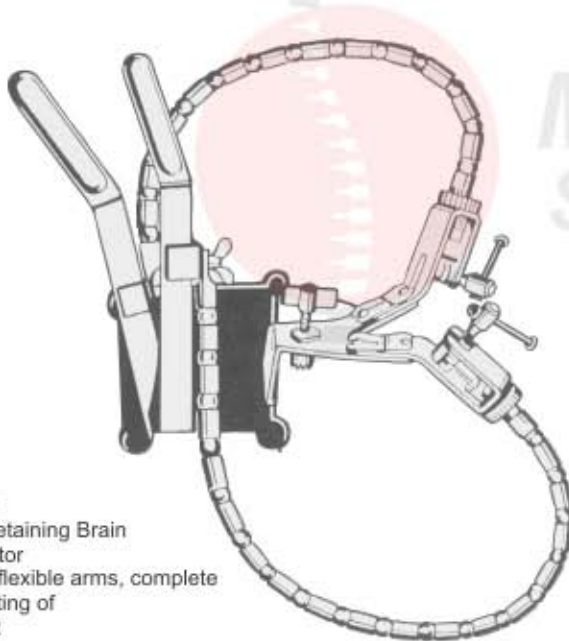

Leyla
Self-Retaining Brain
Retractor
with 2 flexible arms, complete
consisting of
11-062
11-063
11-064



11-070
Brain retractor self retaining, with 1 flexible arm,
complete consisting of fixation base for 1 flexible
arm flexible arm only support for flat brain spatulas



11-065
Fixation base only
holding 2 flexible arms
11-066
Support only for flat
brain spatulas

11-067
Fixation base only
holding 1 flexible arms
11-068
Support only for brain spatulas with round shaft of
4mm and 5mm to fix on the flexible arm
11-069
Flexible arm only for attaching
coupling heads and for fixation bases

11-071
Brain retractor self retaining, with 2 flexible arm,
complete consisting of fixation base for 2 flexible
arm flexible arm only support for flat brain spatulas

McKenzie Instrumentarium
McKenzie instruments

Instrumentos McKenzie
Strumenti McKenzie

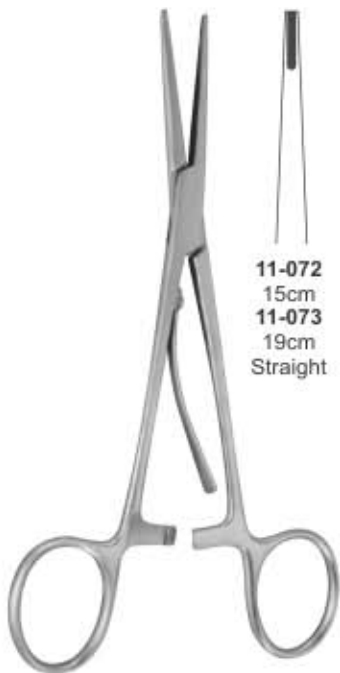

McKenzie Clip Applying Forceps

11-072
15cm
11-073
19cm
Straight

11-074
15cm
11-075
19cm
Curved



McKenzie 11-076
148mm x 40mm x 6mm
Brain clip rack for 20 clips



McKenzie Clip Applying Forceps 11-077
Straight Handle, Curved Jaws, 15cm



McKenzie Clip Applying Forceps 11-078
Curved Handle, Curved Jaws, 15cm



Smithwick Clip Applying Forceps
11-079 23 cm
11-080 26.5 cm
Curved Jaws
Straight Handle



Schwartz Clip Applying Forceps 11-081 20cm
Schwartz Vessel Clip



11-082
2.5cm Straight Jaws 1.7x 8mm



11-083
2.5cm Slightly Angled Jaws 1.7x 8mm



11-084
2.5cm Strong Angled Jaws 1.7x 8mm



Olivecrona Toennis (Scoville), Clip Forceps 11-085 14cm



11-087
Raney Hemostasis Clip



11-088
Kolner Scalp Clip

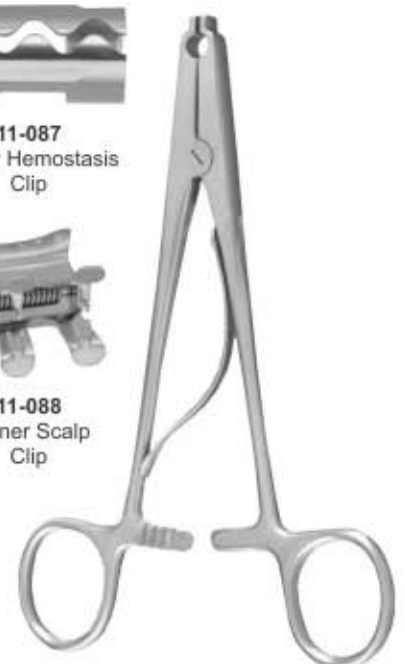

Raney Applyig & Removing Forceps 11-086 15cm

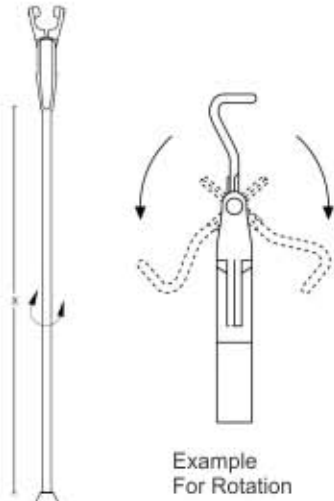

- Mini**
11-089 7cm
11-090 9cm
11-091 11cm
11-092 13cm
non rotating
Standard
11-093 7cm
11-094 9cm
11-095 11cm
11-096 13cm
non rotating



- Mini**
11-097 7cm
11-098 9cm
11-099 11cm
11-100 13cm
rotating
Standard
11-101 7cm
11-102 9cm
11-103 11cm
11-104 13cm
rotating



Applying Forceps



Applying Forceps



- Mini**
11-105 18cm
Straight with ratchet
Standard
11-106 18cm
Straight with ratchet

- Mini**
11-107 17cm
11-108 21cm
11-109 23cm
bayonett shaped, with ratchet
Standard
11-110 17cm
11-111 21cm
11-112 23cm
bayonett shaped, with ratchet



- Cushing, brain spatula**
11-113 7mm x 9mm
11-114 11mm x 13mm
11-115 15mm x 18mm
11-116 18mm x 22mm
18cm



- Olivecrona**
11-117
brain spatula
18cm



- Brain Spatula**
11-118 7mm x 9mm
11-119 11mm x 13mm
11-120 15mm x 18mm
11-121 18mm x 22mm
18cm Convex



- Brain Spatula**
11-122 7mm x 9mm
11-123 11mm x 13mm
11-124 15mm x 18mm
11-125 18mm x 22mm
18cm Concave



- Heifetz, brain spatula**
11-126 8mm
11-127 11mm
11-128 14mm
11-129 17mm
11-130 20mm
20cm Malleable

<i>Hirnspatel</i>	<i>Espatules cerebrales</i>
<i>Spatules cerebrales</i>	<i>Spatole cerebrali</i>

NERVE HOOKS



Scoville, Nerve Root Retractor
11-131 23cm
8mm



Holsher Nerve Root Retractor
11-132 24cm
7mm

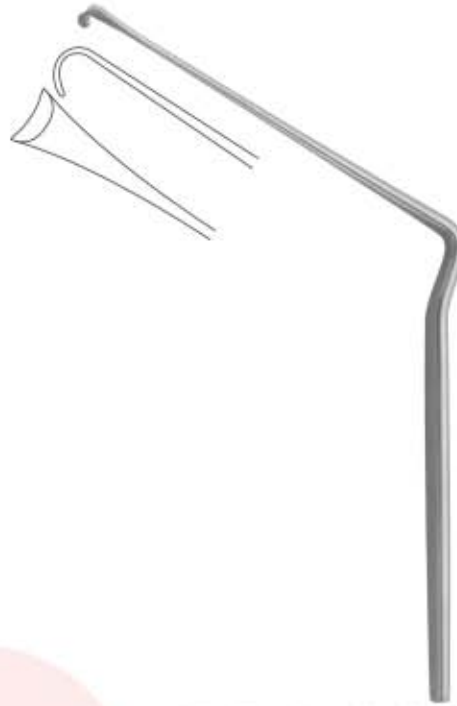

Martin Nerve Root Retractor
11-133 21cm
7mm



Toennis Nerve Dura Hook

11-134
15cm

11-135
19cm



Halle Nerve Dura Hook
11-136 20cm



Smithwick Nerve Dura Hook
11-137 17cm
11-138 21cm



Hoen Nerve Dura Hook
11-139 22cm

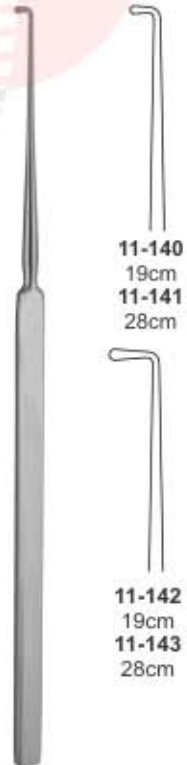

Cushing Nerve Dura Hook

11-140
19cm
11-141
28cm

11-142
19cm
11-143
28cm



Olivecrona Dura Dissector
11-144 18cm



Olivecrona Dura Dissector
11-145 20cm



Milligan Dura Dissector
11-146 21.5 cm



Davis Dura Dissector sharp
11-147 21.5 cm

Nervenhaken - Durahaken

Ganchos para nervios - Ganchos para duramadre

Crochets a nerfs - Crochets pour duremers

Uncini per nervi - Uncini per duramadre



Graham Nerve Dura Hook
11-148
18.5cm



Frazier Nerve Dura Hook
11-149
17cm



Dandy Nerve Dura Hook
11-150
20cm



Dandy Nerve Dura Hook
11-151
20cm



Dandy Nerve Dura Hook
11-152
20cm



Adson Nerve Dura Hook



11-153
20cm



11-154
20cm



Yasargil Nerve Dura Hook Retractor
11-155 21cm
11-156 41cm
Galea retractor



Love Nerve Dura Hook Retractor
11-157 19cm
Straight



Love Nerve Dura Hook Retractor
11-158 19cm
45° Angled



Love Nerve Dura Hook Retractor
11-159
19cm
90° Angled



Cushing Nerve Dura Hook Retractor
11-160 14cm



Frazier Nerve Dura Hook Retractor

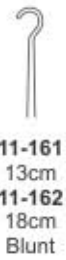

11-161
13cm



11-162
18cm



Blunt



Lahey Nerve Dura Hook Retractor
11-163
13cm

MANZIM
SURGICO

DURA DISSECTORS

Dura-Dissektoren
Decolleurs duremere

Disectores de duramadre
Dissetori per duramadre



Toennis Dura Dissector
11-164
25cm



Davis Dura Dissector
11-165
24.5cm



Dura Dissector
11-166 22cm



Sachs Dura Dissector
11-167 21cm



Sachs Dura Dissector
11-168 21cm



Sachs Dura Dissector
11-169
21cm

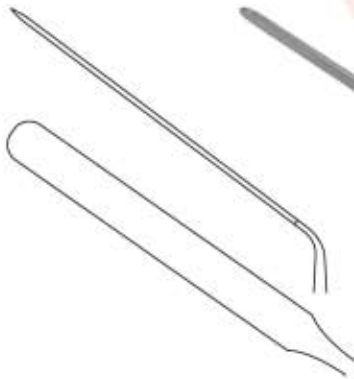

Horsley Dura Dissector
11-170
20cm

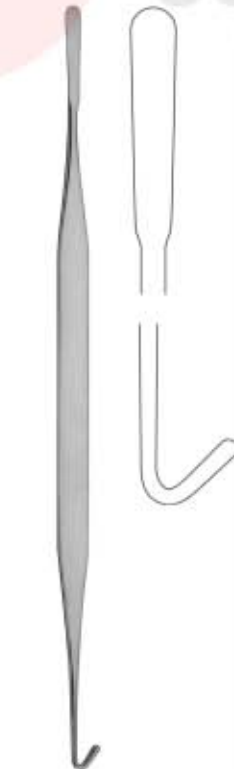

Smithwich Dura Dissector
11-171
30.5cm



Groningen
11-172
Nerve Hook
26.5 cm



Groningen
11-173
Nerve Hook
26.5 cm



11-174
A



11-175
B



Cushing
Nerve Hook blunt
19 cm

DURA DISSECTORS

Dura-Dissektoren | *Disectores de duramadre*
Decolleurs duremere | *Dissetori per duramadre*

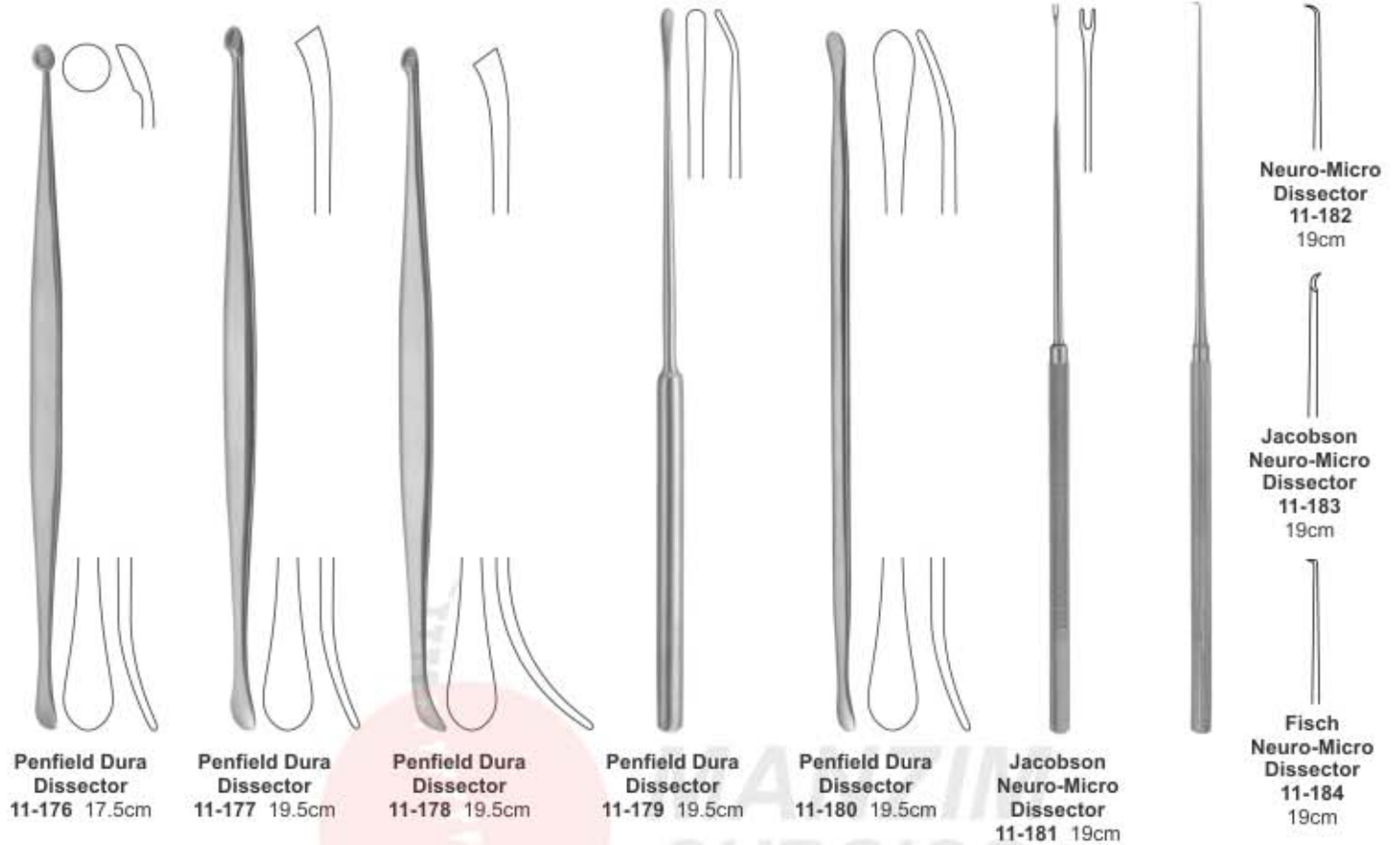

NEURO-DISSECTORS AND CURETTES

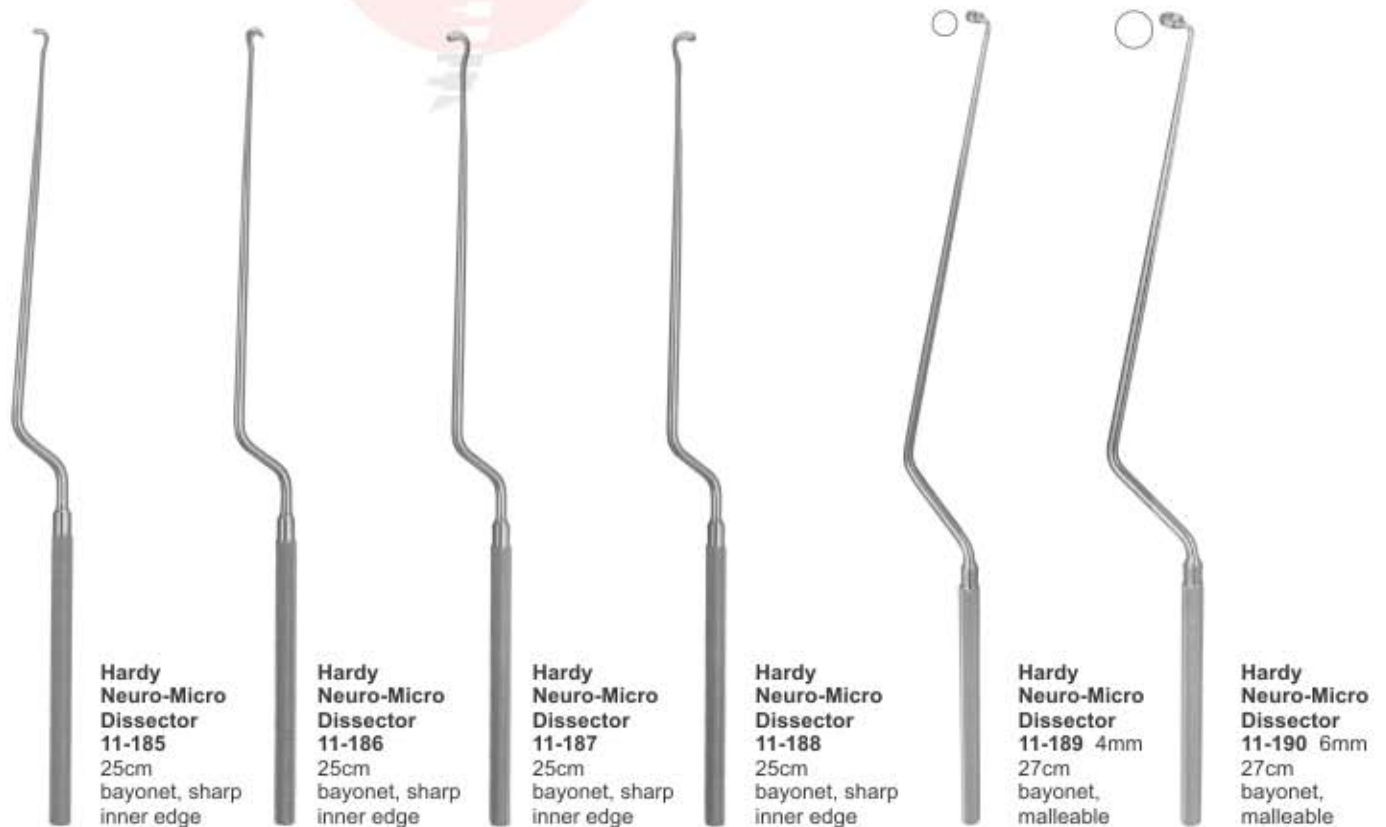

NEURO-MICRO DISSECTORS

Neuro-Mikro-Dissektoren
Neuro-micro dissecteurs

Disectores para micro-neurocirugia
Strumento per micro-neuro chirurgia



Yasargil Neuro-Micro Dissector



11-191
19cm
Straight
11-192
19cm
bayonet

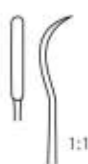

11-193
19cm
Straight
11-194
19cm
bayonet



11-195
19cm
Straight
11-196
19cm
bayonet



11-197
19cm
Straight
11-198
19cm
bayonet



11-199
19cm
Straight
11-200
19cm
bayonet



11-201
19cm
Straight
11-202
19cm
bayonet



11-203
19cm
Straight
11-204
19cm
bayonet



11-205
19cm
Straight
11-206
19cm
bayonet



11-207
19cm
Straight
11-208
19cm
bayonet



11-209
19cm
Straight, with
Twist-fixationhook



11-210
19cm
Straight, with
Twist-fixationhook



Kraus
11-211
19cm
bayonet



Yasargil
11-212
19cm
bayonet



Koos
11-213
19cm
bayonet



Koos
11-214
19cm
bayonet



Koos
11-215
19cm
bayonet



Neuro-Micro Dissector

Laminektomiestanzen
Pinces emporte-pieces a laminectomie

Pinzas cortantes para laminectomia
Pinze taglienti per laminectomia



**Cushing Intervertebral
Disc Rongeurs**
2 X 10mm, 15cm
11-216 straight
11-217 UP
11-218 Down



**Love-Gruenwald
Intervertebral Disc Rongeurs**
3 X 10mm, 15cm
11-240 straight
11-241 Up
11-242 Down

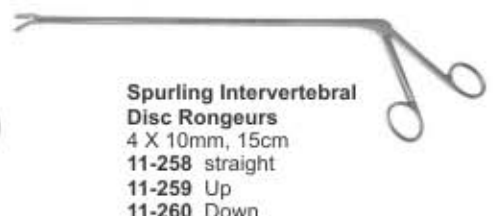

**Spurling Intervertebral
Disc Rongeurs**
4 X 10mm, 15cm
11-258 straight
11-259 Up
11-260 Down

1.5 X 10mm, 18cm
11-219 straight
11-220 Up
11-221 Down

3 X 10mm, 18cm
11-243 straight
11-244 Up
11-245 Down

4 X 10mm, 18cm
11-261 straight
11-262 Up
11-263 Down

2 X 10mm, 18cm
11-222 straight
11-223 UP
11-224 Down

3 X 10mm, 23cm
11-246 straight
11-247 Up
11-248 Down

4 X 10mm, 23cm
11-264 straight
11-265 Up
11-266 Down

1.5 X 10mm, 23cm
11-225 straight
11-226 Up
11-227 Down

3 X 10mm, 25.5cm
11-249 straight
11-250 Up
11-251 Down

4 X 10mm, 25.5cm
11-267 straight
11-268 Up
11-269 Down

2 X 10mm, 23cm
11-228 straight
11-229 UP
11-230 Down

3 X 10mm, 28cm
11-252 straight
11-253 Up
11-254 Down

4 X 10mm, 28cm
11-270 straight
11-271 Up
11-272 Down

2 X 10mm, 25.5cm
11-231 straight
11-232 UP
11-233 Down

3 X 10mm, 30.5cm
11-255 straight
11-256 Up
11-257 Down

4 X 10mm, 30.5cm
11-273 straight
11-274 Up
11-275 Down

2 X 10mm, 28cm
11-234 straight
11-235 UP
11-236 Down

2 X 10mm, 30.5cm
11-237 straight
11-238 UP
11-239 Down

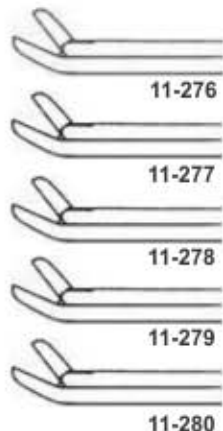

Cushing
Laminectomy Rongeur jaw 2 x 10 to 4 x 10
mm straight shaft length 180 mm

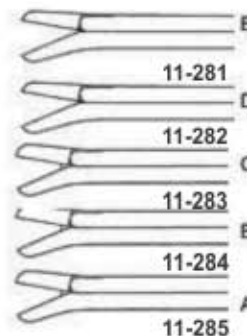

Cushing
Laminectomy Rongeur jaw 2 x 10 to 4 x 10
mm upwards 45 degree

**MANZIM
SURGICO**

Laminektomiestanzen

Pinzas cortantes para laminectomia

Pinces emporte-pieces a laminectomie

Pinze taglianti per laminectomia

Wilde Intervertebral Disc Rongeurs

18cm Straight
11-286 2.5mm
11-287 3mm
11-288 4mm
11-289 5mm

18cm Angled up
11-290 2.5mm
11-291 3mm
11-292 4mm
11-293 5mm

23.5cm Straight
11-294 3mm
11-295 4mm
11-296 5mm



Caspar Type Intervertebral Disc Rongeurs

16cm Straight
11-297 2 x 12mm
11-298 3 x 12mm
11-299 4 x 14mm
11-300 5 x 14mm
11-301 6 x 16mm

16cm Up
11-302 3 x 12mm
11-303 4 x 14mm
11-304 5 x 14mm

16cm Down
11-305 3 x 12mm
11-306 4 x 14mm



Caspar Type Intervertebral Disc Rongeurs

18.5cm Straight
11-307 2 x 12mm
11-308 3 x 12mm
11-309 4 x 14mm
11-310 5 x 14mm
11-311 6 x 16mm

18.5cm Up
11-312 2 x 12mm
11-313 3 x 12mm
11-314 4 x 14mm
11-315 5 x 14mm

18.5cm Down
11-316 2 x 12mm
11-317 3 x 12mm
11-318 4 x 14mm



Cushing Intervertebral Disc Rongeurs

w/teeth 2 x 10mm, 18cm
11-319 Straight
11-320 Up
11-321 Down

L-G Intervertebral Disc Rongeurs

w/teeth 3 x 10mm, 18cm
11-322 Straight
11-323 Up
11-324 Down

3 x 10mm, 25.5cm
11-325 Straight



Schlesinger Intervertebral Disc Rongeurs

11-326 2 x 10mm, 13cm Straight
11-327 3 x 10mm, 13cm Straight
11-328 4 x 10mm, 13cm Straight
11-329 3 x 10mm, 13cm Angled Up

Cloward Intervertebral Disc Rongeurs

serrated 6 x 10mm, 13cm
11-330 Straight
11-331 Up
11-332 Down



Oldberg Intervertebral Disc Rongeurs

11-333 6mm Diameter
18.5cm



Selverstone Intervertebral Disc Rongeurs

11-334 2 x 3mm, 15cm
11-335 2 x 5mm, 15cm



Cushing Intervertebral Disc Rongeurs

2 X 10mm, 13cm
11-336 Straight
11-337 UP
11-338 Down

Love-Gruenwald Intervertebral Disc Rongeurs

3 X 10mm, 13cm
11-339 Straight
11-340 Up
11-341 Down

Spurling Intervertebral Disc Rongeurs

4 X 10mm, 13cm
11-342 Straight
11-343 Up
11-344 Down

Laminectomiestanzen
Pincas emporte-pieces a laminectomie

Pinzas cortantes para laminectomia
Pinze taglianti per laminectomia



Decker Intervertebral Disc Rongeurs
2 x 5mm, 15cm
11-345 Right
11-346 Left
11-347 Down
11-348 Up
11-349 Straight



Jackson Intervertebral Disc Rongeurs
70° Up 18cm
11-350 2 x 8mm
11-351 3 x 8mm
11-352 4 x 8mm



Williams Style Micro Disc Intervertebral Disc Rongeurs
1 x 2 teeth, Straight
11-353 14cm
11-354 18cm
11-355 25.5cm



Micro Cup Forceps
14cm, 0.5mm
11-356 Straight
11-357 Right
11-358 Left



Micro Cup Forceps
14cm 1mm
11-359 Straight
11-360 Right
11-361 Left
14cm 2mm
11-362 Straight

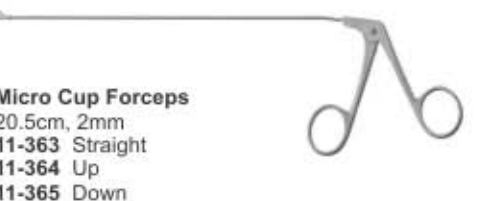

Micro Cup Forceps
20.5cm, 2mm
11-363 Straight
11-364 Up
11-365 Down



Well Blakesley Laminectomy rongeurs



12cm
Straight

Fig. 1
3.0mm
11-366

Fig. 2
3.5mm
11-367

Fig. 3
4.5mm
11-368

Fig. 4
5.0mm
11-369

Fig. 5
5.5mm
11-370



12cm
45° up

11-371

11-372

11-373

11-374

11-375



12cm
90° up

11-376

11-377

11-378



18cm
45° up

Fig. 1
3.0mm
11-379

Fig. 2
3.5mm
11-380

Fig. 3
4.5mm
11-381

Fig. 4
5.0mm
11-382

Fig. 5
5.5mm
11-383



18cm 7"
90° up

11-384

11-385

11-386

11-387

Laminectomiestanzen

Pinzas cortantes para laminectomia

Pinces emporte-pieces a laminectomie

Pinze taglianti per laminectomia

Ferris Smith Micro Kerrison Laminectomy Rongeurs

45° UP 9mm bite opening 18cm

- 11-388 1mm
- 11-389 2mm
- 11-390 3mm
- 11-391 4mm
- 11-392 5mm
- 11-393 6mm

90° UP 9mm bite opening 20.5cm

- 11-394 1mm
- 11-395 2mm
- 11-396 3mm
- 11-397 4mm
- 11-398 5mm
- 11-399 6mm

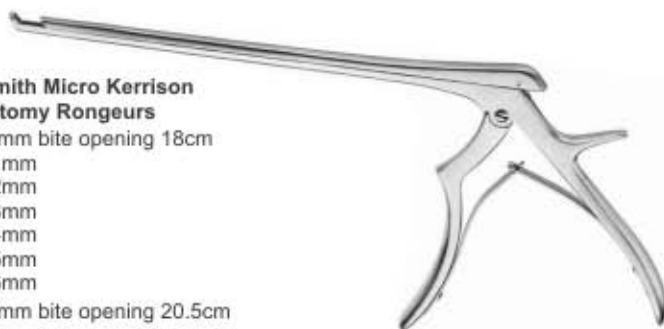

Ferris Smith Micro Kerrison Laminectomy Rongeurs

45° Down 9mm bite opening 18cm

- 11-400 1mm
- 11-401 2mm
- 11-402 3mm
- 11-403 4mm
- 11-404 5mm
- 11-405 6mm

90° Down 9mm bite opening, 20.5cm

- 11-406 1mm
- 11-407 2mm
- 11-408 3mm
- 11-409 4mm
- 11-410 5mm
- 11-411 6mm

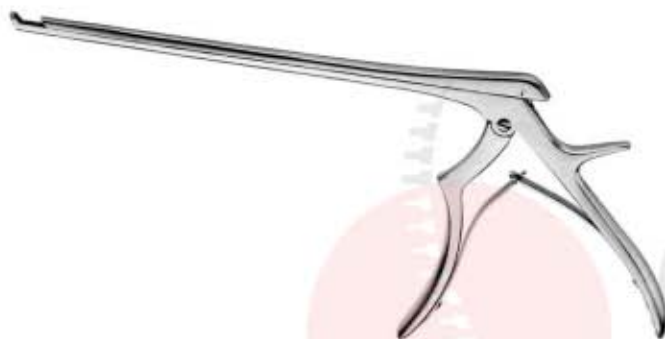

Ferris Smith Micro Kerrison Laminectomy Rongeurs UPWARD

40° UP

9mm bite opening, 18cm

- 11-412 1mm
- 11-413 2mm
- 11-414 3mm
- 11-415 4mm
- 11-416 5mm
- 11-417 6mm

40° UP

9mm bite opening, 23cm

- 11-435 1mm
- 11-436 2mm
- 11-437 3mm
- 11-438 4mm
- 11-439 5mm
- 11-440 6mm

40° Down

9mm bite opening, 18cm

- 11-418 2mm
- 11-419 3mm
- 11-420 4mm
- 11-421 5mm
- 11-422 6mm

40° UP

9mm bite opening, 25.5cm

- 11-441 2mm
- 11-442 3mm
- 11-443 4mm
- 11-444 5mm
- 11-445 6mm

40° UP

9mm bite opening, 20.5cm

- 11-423 1mm
- 11-424 2mm
- 11-425 3mm
- 11-426 4mm
- 11-427 5mm
- 11-428 6mm

40° UP

9mm bite opening,

- 11-446 2mm
- 11-447 3mm
- 11-448 4mm
- 11-449 5mm
- 11-450 6mm

40° Down

9mm bite opening, 20.5cm

- 11-429 1mm
- 11-430 2mm
- 11-431 3mm
- 11-432 4mm
- 11-433 5mm
- 11-434 6mm

40° UP

9mm bite opening, 30.5cm

- 11-451 2mm
- 11-452 3mm
- 11-453 4mm
- 11-454 5mm
- 11-455 6mm



Ferris Smith Micro Kerrison Laminectomy Rongeurs DOWNWARD

130° Down

9mm bite opening, 18cm

- 11-456 1mm
- 11-457 2mm
- 11-458 3mm
- 11-459 4mm
- 11-460 5mm
- 11-461 6mm

130° Down

9mm bite opening, 28cm

- 11-480 1mm
- 11-481 2mm
- 11-482 3mm
- 11-483 4mm
- 11-484 5mm
- 11-485 6mm

130° Down

9mm bite opening, 20.5cm

- 11-462 1mm
- 11-463 2mm
- 11-464 3mm
- 11-465 4mm
- 11-466 5mm
- 11-467 6mm

130° Down

9mm bite opening, 30.5cm

- 11-486 1mm
- 11-487 2mm
- 11-488 3mm
- 11-489 4mm
- 11-490 5mm
- 11-491 6mm

130° Down

9mm bite opening, 23cm

- 11-468 1mm
- 11-469 2mm
- 11-470 3mm
- 11-471 4mm
- 11-472 5mm
- 11-473 6mm

130° Down

9mm bite opening, 25.5cm

- 11-474 1mm
- 11-475 2mm
- 11-476 3mm
- 11-477 4mm
- 11-478 5mm
- 11-479 6mm

Laminektomiestanzen

Pinces emporte-pieces a laminectomie

Pinzas cortantes para laminectomia

Pinze taglianti per laminectomia



**Micro Ejector Kerrison
Laminectomy Rongeurs**

40° Up 20.5cm
11-492 2mm
11-493 3mm
11-494 4mm
11-495 5mm
11-496 6mm

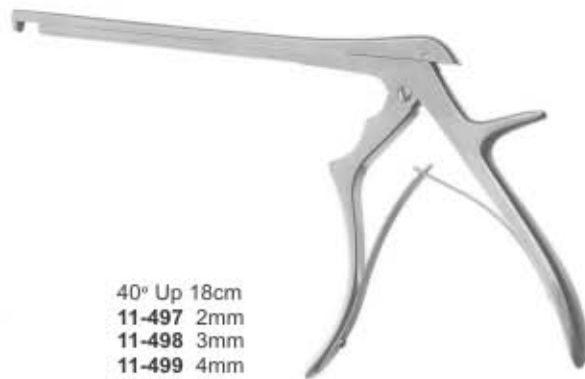

**Wide Mouth Ejector Kerrison
Laminectomy Rongeurs**

40° Up 18cm
11-497 2mm
11-498 3mm
11-499 4mm
11-500 5mm
11-501 6mm

40° Up 20.5cm
11-502 2mm
11-503 3mm
11-504 4mm
11-505 5mm
11-506 6mm



**Spurling Kerrison
Laminectomy Rongeurs
Large Handle**

40° UP,
15mm Bite Opening, 18cm
11-507 2mm
11-508 3mm
11-509 4mm
11-510 5mm
11-511 6mm

40° UP,
15mm Bite Opening, 25.5cm
11-522 2mm
11-523 3mm
11-524 4mm
11-525 5mm
11-526 6mm



**Spurling Kerrison
Laminectomy Rongeurs
Large Handle**

90° UP,
15mm Bite Opening, 18cm
11-532 2mm
11-533 3mm
11-534 4mm
11-535 5mm
11-536 6mm



**Spurling Kerrison
Laminectomy Rongeurs
Large Handle**

90° Down,
15mm Bite Opening, 18cm
11-542 2mm
11-543 3mm
11-544 4mm
11-545 5mm
11-546 6mm

40° UP,
15mm Bite Opening, 20.5cm
11-512 2mm
11-513 3mm
11-514 4mm
11-515 5mm
11-516 6mm

40° UP,
15mm Bite Opening, 28cm
11-527 2mm
11-528 3mm
11-529 4mm
11-530 5mm
11-531 6mm

90° UP,
15mm Bite Opening, 20.5cm
11-537 2mm
11-538 3mm
11-539 4mm
11-540 5mm
11-541 6mm

90° Down,
15mm Bite Opening, 20.5cm
11-547 2mm
11-548 3mm
11-549 4mm
11-550 5mm
11-551 6mm

40° UP,
15mm Bite Opening, 23cm
11-517 2mm
11-518 3mm
11-519 4mm
11-520 5mm
11-521 6mm

Laminektomiestanzen

Pinzas cortantes para laminectomia

Pinces emporte-pieces a laminectomie

Pinze taglianti per laminectomia



Foramenotomy Kerrison

Laminectomy Rongeurs, Curved

- 11-552 UP, 9mm Bite opening, 20.5cm 2mm
- 11-553 UP, 9mm Bite opening, 20.5cm 3mm
- 11-554 UP, 9mm Bite opening, 20.5cm 4mm
- 11-555 UP, 9mm Bite opening, 20.5cm 5mm
- 11-556 UP, 9mm Bite opening, 20.5cm 6mm
- 11-557 Left, 9mm Bite opening, 20.5cm 6mm
- 11-558 Right, 9mm Bite opening, 20.5cm 6mm

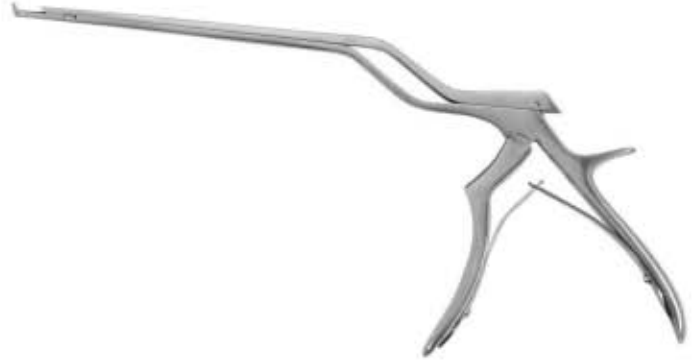

Bayonet Micro Kerrison Laminectomy Rongeurs

- 40° Up, 150 mm Working Length 20.5cm
- 11-559 1mm
- 11-560 2mm
- 11-561 3mm
- 11-562 4mm
- 11-563 5mm
- 11-564 6mm



Spurling Laminectomy Rongeurs

- 90° Up, 150 mm Working Length 20.5cm
- 11-565 1mm
- 11-566 2mm
- 11-567 3mm
- 11-568 4mm
- 11-569 5mm
- 11-570 6mm

Bayonet Spurling Kerrison Laminectomy Rongeurs

- 40° Up, 150 mm Working Length 20.5cm
- 11-571 1mm
- 11-572 2mm
- 11-573 3mm
- 11-574 4mm
- 11-575 5mm
- 11-576 6mm

- 90° Up, 150 mm Working Length 20.5cm
- 11-577 1mm
- 11-578 2mm
- 11-579 3mm
- 11-580 4mm
- 11-581 5mm
- 11-582 6mm

- 40° UP, 15mm Bite Opening, 18cm
- 11-583 2mm
- 11-584 3mm
- 11-585 4mm
- 11-586 5mm
- 11-587 6mm

- 40° UP, 15mm Bite Opening, 23cm
- 11-593 2mm
- 11-594 3mm
- 11-595 4mm
- 11-596 5mm
- 11-597 6mm

- 40° UP, 15mm Bite Opening, 20.5cm
- 11-588 2mm
- 11-589 3mm
- 11-590 4mm
- 11-591 5mm
- 11-592 6mm

- 40° UP, 15mm Bite Opening, 25.5cm
- 11-598 2mm
- 11-599 3mm
- 11-600 4mm
- 11-601 5mm
- 11-602 6mm

- 40° UP, 15mm Bite Opening, 28cm
- 11-603 2mm
- 11-604 3mm
- 11-605 4mm
- 11-606 5mm
- 11-607 6mm

Laminectomiestanzen
Pinces emporte-pieces a laminectomie

Pinzas cortantes para laminectomia
Pinze taglianti per laminectomia

90° UP, 15mm Bite Opening, 18cm
11-608 2mm
11-609 3mm
11-610 4mm
11-611 5mm
11-612 6mm

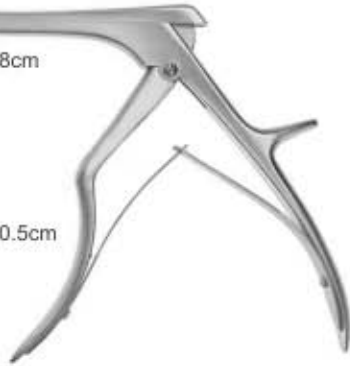

Spurling Laminectomy Rongeurs

90° UP, 15mm Bite Opening, 20.5cm
11-613 2mm
11-614 3mm
11-615 4mm
11-616 5mm
11-617 6mm

90° Down, 15mm Bite Opening, 18cm
11-618 2mm
11-619 3mm
11-620 4mm
11-621 5mm
11-622 6mm



Spurling Laminectomy Rongeurs

90° Down, 15mm Bite Opening, 20.5cm
11-623 2mm
11-624 3mm
11-625 4mm
11-626 5mm
11-627 6mm

Micro Ejector Kerrison Laminectomy Rongeurs

40° Up 20.5cm
11-628 2mm
11-629 3mm
11-630 4mm
11-631 5mm
11-632 6mm

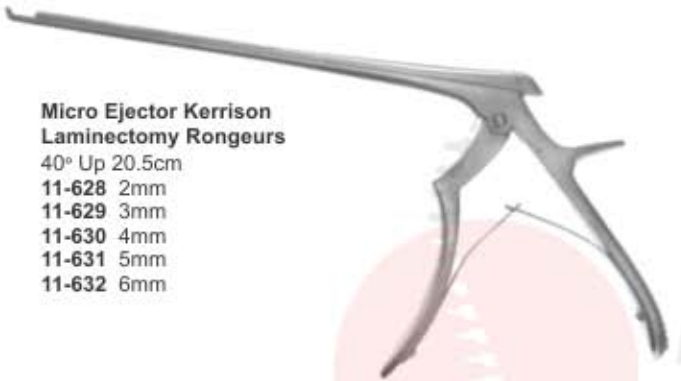

Wide Mouth Ejector Kerrison Laminectomy Rongeurs

40° Up 18cm	40° Up 20.5cm
11-633 2mm	11-638 2mm
11-634 3mm	11-639 3mm
11-635 4mm	11-640 4mm
11-636 5mm	11-641 5mm
11-637 6mm	11-642 6mm



Ferris Smith Micro Kerrison Laminectomy Rongeurs

130° Down Bite, 28cm
11-643 4mm
11-644 5mm
11-645 6mm

130° Down Bite, 30.5cm
11-646 1mm
11-647 2mm
11-648 3mm
11-649 4mm
11-650 5mm
11-651 6mm



Spurling Intervertebral Disc Rongeurs

w/teeth 4 x 10mm, 18cm
11-652 Straight
11-653 Up
11-654 Down

4 x 10mm, 25.5cm
11-655 Straight

5 x 10mm, 25.5cm
11-656 Straight



Kerrison Cervical Rongeur

11-657
17.8 cm shaft, 3 mm
40 degree forward angle



Schlesinger Cervical Rongeur

11-658
thin tips, 15 cm shaft, up-bite, 3 mm



Laminektomiestanzen

Pinzas cortantes para laminectomia

Pinces emporte-pieces a laminectomie

Pinze taglianti per laminectomia



Ferris-Smith Intervertebral Disc Rongeurs

- 18cm straight
- 11-659 2 x 10mm
- 11-660 3 x 10mm
- 11-661 4 x 8mm
- 11-662 4 x 10mm
- 11-663 6 x 10mm
- 11-664 6 x 12mm

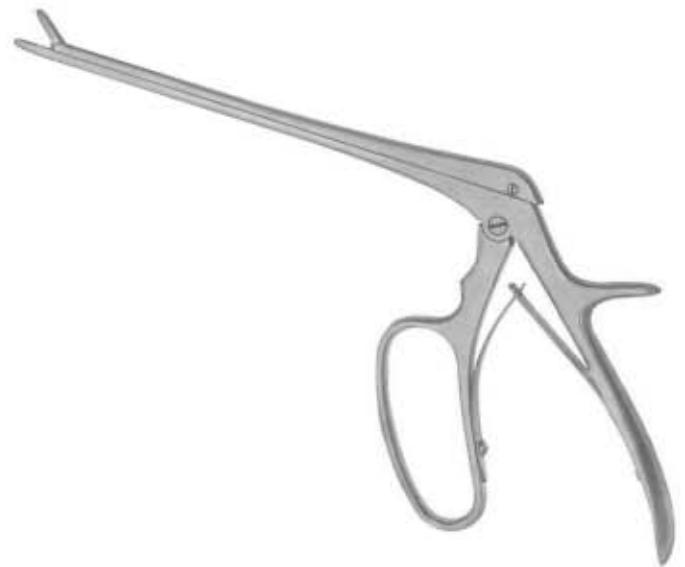

Ferris-Smith Intervertebral Disc Rongeurs

- 18cm Up
- 11-665 2 x 10mm
- 11-666 3 x 10mm
- 11-667 4 x 10mm
- 11-668 6 x 10mm

- 18cm Down
- 11-669 2 x 10mm
- 11-670 3 x 10mm
- 11-671 4 x 10mm
- 11-672 6 x 10mm



MANZIM SURGICO



Peapod Intervertebral Disc Rongeurs, 14cm

- 11-673 Angle up 1.5mm, x-small
- 11-674 Angle up 2mm, small
- 11-675 Angle up 2.5mm, medium
- 11-676 Angle up 3mm, large



Peapod Intervertebral Disc Rongeurs,

- 11-677 Angle up 2.5mm, 18cm
- 11-678 Angle up 3mm, 18cm
- 11-679 Angle up 4mm, 18cm
- 11-680 Straight 2mm, 14cm
- 11-681 Straight 2.5mm, 14cm
- 11-682 Straight 3mm, 14cm

Laminectomiestanzen
Pincas emporte-pieces a laminectomie

Pinzas cortantes para laminectomia
Pinze taglienti per laminectomia

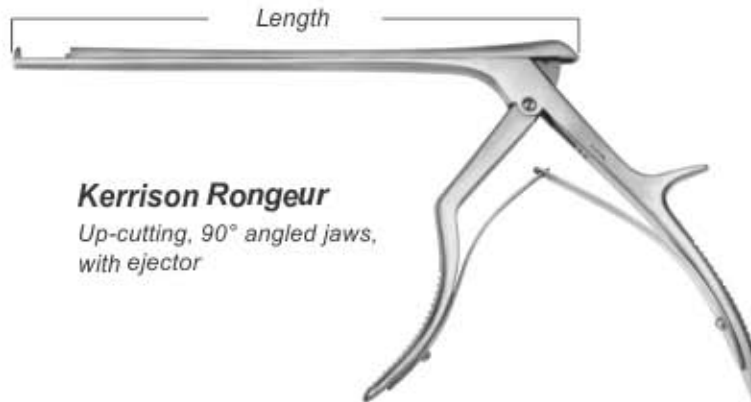

Kerrison Rongeur

Up-cutting, 90° angled jaws,
with ejector

Ferris-Smith Kerrison handle	Kerrison Small handle	Kerrison Large handle	Jaw size (width x height)	Length*
		11-707	2,0 x 2,0 mm	18 cm
11-683	11-695	11-708	2,5 x 2,5 mm	18 cm
11-684	11-696	11-709	2,0 x 3,0 mm	18 cm
11-685	11-697	11-710	3,0 x 4,0 mm	18 cm
11-686	11-698	11-711	4,0 x 5,0 mm	18 cm
11-687	11-699	11-712	5,0 x 5,0 mm	18 cm
11-688	11-700	11-713	6,0 x 5,0 mm	18 cm
		11-714	7,0 x 6,0 mm	18 cm
		11-715	2,0 x 2,0 mm	20 cm
11-689	11-701	11-716	2,5 x 2,5 mm	20 cm
11-690	11-702		2,0 x 3,0 mm	20 cm
11-691	11-703	11-717	3,0 x 4,0 mm	20 cm
11-692	11-704	11-718	4,0 x 5,0 mm	20 cm
11-693	11-705	11-719	5,0 x 5,0 mm	20 cm
11-694	11-706	11-720	6,0 x 5,0 mm	20 cm
		11-721	7,0 x 6,0 mm	20 cm
		11-722	2,0 x 2,0 mm	22 cm
		11-723	2,5 x 2,5 mm	22 cm
		11-724	2,0 x 3,0 mm	22 cm
		11-725	3,0 x 4,0 mm	22 cm
		11-726	4,0 x 5,0 mm	22 cm
		11-727	5,0 x 5,0 mm	22 cm
		11-728	6,0 x 5,0 mm	22 cm
		11-729	7,0 x 6,0 mm	22 cm
		11-730	2,0 x 2,0 mm	25 cm
		11-731	2,0 x 3,0 mm	25 cm
		11-732	3,0 x 4,0 mm	25 cm
		11-733	4,0 x 5,0 mm	25 cm
		11-734	5,0 x 5,0 mm	25 cm
		11-735	2,0 x 2,0 mm	30 cm
		11-736	3,0 x 4,0 mm	30 cm
		11-737	4,0 x 5,0 mm	30 cm
		11-738	5,0 x 5,0 mm	30 cm

Maulgrößen / Jaw sizes:

- 2,0 x 2,0 mm
- 2,5 x 2,5 mm
- 2,0 x 3,0 mm
- 3,0 x 4,0 mm
- 4,0 x 5,0 mm
- 5,0 x 5,0 mm
- 6,0 x 5,0 mm
- 7,0 x 6,0 mm

* Lengths are measured with closed jaws

Laminektomiestanzen

Pinzas cortantes para laminectomia





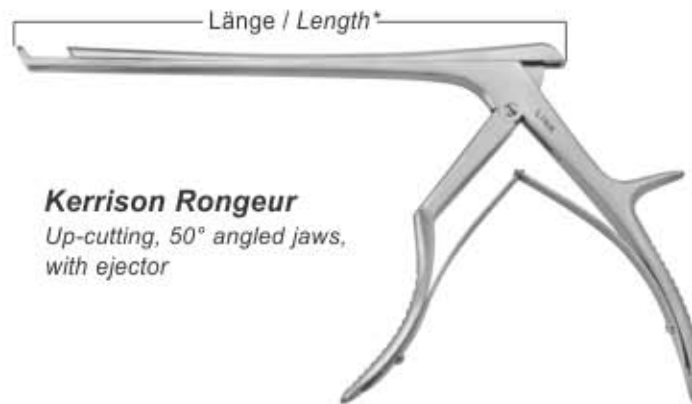







Pinces emporte-pieces a laminectomie

Pinze taglianti per laminectomia



Kerrison Rongeur

Up-cutting, 50° angled jaws,
with ejector

Ferris-Smith Kerrison handle	Kerrison Small handle	Kerrison Large handle	Jaw size (width x height)	Length*
				
		11-763	2,0 x 2,0 mm	18 cm
11-739	11-751	11-764	2,5 x 2,5 mm	18 cm
11-740	11-752		2,0 x 3,0 mm	18 cm
11-741	11-753	11-765	3,0 x 4,0 mm	18 cm
11-742	11-754	11-766	4,0 x 5,0 mm	18 cm
11-743	11-755	11-767	5,0 x 5,0 mm	18 cm
11-744	11-756	11-768	6,0 x 5,0 mm	18 cm
		11-769	7,0 x 6,0 mm	18 cm
		11-770	2,0 x 2,0 mm	20 cm
11-745	11-757	11-771	2,5 x 2,5 mm	20 cm
11-746	11-758	11-772	2,0 x 3,0 mm	20 cm
11-747	11-759	11-773	3,0 x 4,0 mm	20 cm
11-748	11-760	11-774	4,0 x 5,0 mm	20 cm
11-749	11-761	11-775	5,0 x 5,0 mm	20 cm
11-750	11-762	11-776	6,0 x 5,0 mm	20 cm
		11-777	7,0 x 6,0 mm	20 cm
Maulgrößen / Jaw sizes:				
	2,0 x 2,0 mm	11-778	2,0 x 2,0 mm	22 cm
	2,5 x 2,5 mm	11-779	2,5 x 2,5 mm	22 cm
	2,0 x 3,0 mm	11-780	3,0 x 4,0 mm	22 cm
	3,0 x 4,0 mm	11-781	4,0 x 5,0 mm	22 cm
	4,0 x 5,0 mm	11-782	5,0 x 5,0 mm	22 cm
	5,0 x 5,0 mm	11-783	6,0 x 5,0 mm	22 cm
	6,0 x 5,0 mm	11-784	7,0 x 6,0 mm	22 cm
	7,0 x 6,0 mm	11-785	2,0 x 2,0 mm	25 cm
		11-786	3,0 x 4,0 mm	25 cm
		11-787	4,0 x 5,0 mm	25 cm
		11-788	5,0 x 5,0 mm	25 cm
		11-789	2,0 x 2,0 mm	30 cm
		11-790	3,0 x 4,0 mm	30 cm
		11-791	4,0 x 5,0 mm	30 cm
		11-792	5,0 x 5,0 mm	30 cm



*Lengths are measured with closed jaws

Laminektomiestanzen
Pincas emporte-pieces a laminectomie

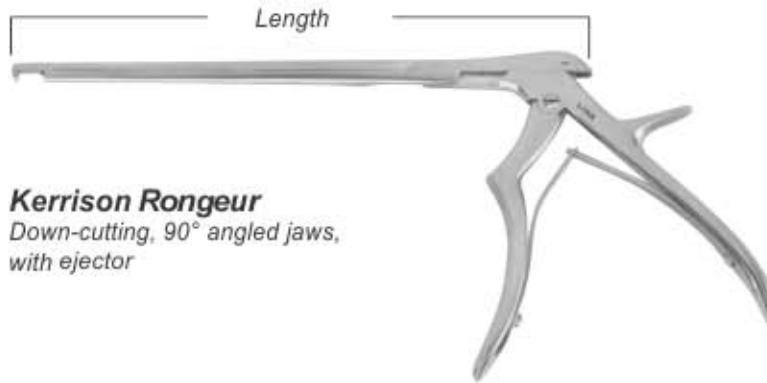







Pinzas cortantes para laminectomia
Pinze taglienti per laminectomia



Kerrison Rongeur
Down-cutting, 90° angled jaws,
with ejector

Ferris-Smith Kerrison handle	Kerrison Small handle	Kerrison Large handle	Jaw size (width x height) Length*	
				
		11-817	2,0 x 2,0 mm	18 cm
11-793	11-805	11-818	2,5 x 2,5 mm	18 cm
11-794	11-806		2,0 x 3,0 mm	18 cm
11-795	11-807	11-819	3,0 x 4,0 mm	18 cm
11-796	11-808	11-820	4,0 x 5,0 mm	18 cm
11-797	11-809	11-821	5,0 x 5,0 mm	18 cm
11-798	11-810	11-822	6,0 x 5,0 mm	18 cm
		11-823	7,0 x 6,0 mm	18 cm
		11-824	2,0 x 2,0 mm	20 cm
11-799	11-811	11-825	2,5 x 2,5 mm	20 cm
11-800	11-812	11-826	2,0 x 3,0 mm	20 cm
11-801	11-813	11-827	3,0 x 4,0 mm	20 cm
11-802	11-814	11-828	4,0 x 5,0 mm	20 cm
11-803	11-815	11-829	5,0 x 5,0 mm	20 cm
11-804	11-816	11-830	6,0 x 5,0 mm	20 cm
		11-831	7,0 x 6,0 mm	20 cm
		11-832	2,0 x 2,0 mm	22 cm
		11-833	2,5 x 2,5 mm	22 cm
		11-834	2,0 x 3,0 mm	22 cm
		11-835	3,0 x 4,0 mm	22 cm
		11-836	4,0 x 5,0 mm	22 cm
		11-837	5,0 x 5,0 mm	22 cm
		11-838	6,0 x 5,0 mm	22 cm
		11-839	7,0 x 6,0 mm	22 cm
		11-840	2,0 x 2,0 mm	25 cm
		11-841	2,0 x 3,0 mm	25 cm
		11-842	3,0 x 4,0 mm	25 cm
		11-843	4,0 x 5,0 mm	25 cm
		11-844	5,0 x 5,0 mm	25 cm
		11-845	2,0 x 2,0 mm	30 cm
		11-846	2,0 x 3,0 mm	30 cm
		11-847	3,0 x 4,0 mm	30 cm
		11-848	4,0 x 5,0 mm	30 cm
		11-849	5,0 x 5,0 mm	30 cm

Maulgrößen/ Jaw sizes:

-  2,0 x 2,0 mm
-  2,5 x 2,5 mm
-  2,0 x 3,0 mm
-  3,0 x 4,0 mm
-  4,0 x 5,0 mm
-  5,0 x 5,0 mm
-  6,0 x 5,0 mm
-  7,0 x 6,0 mm

* Lengths are measured with closed jaws

Laminektomiestanzen

Pinzas cortantes para laminectomia

Pinces emporte-pieces a laminectomie

Pinze taglianti per laminectomia

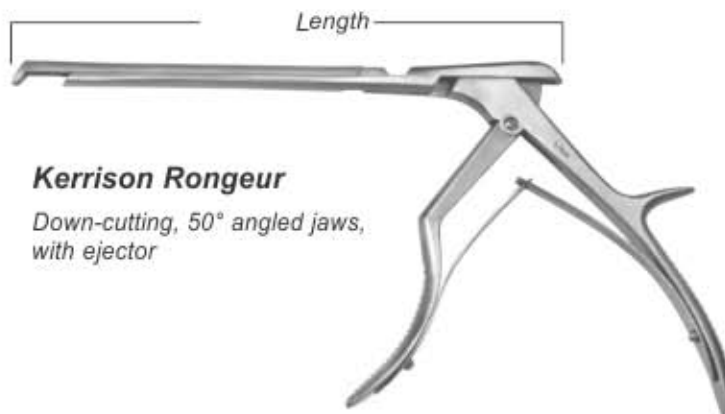

Kerrison Rongeur

Down-cutting, 50° angled jaws, with ejector

Ferris-Smith Kerrison handle	Kerrison Small handle	Kerrison Large handle	Jaw size (width x height)	Length*
		11-874	2,0 x 2,0 mm	18 cm
11-850	11-862	11-875	2,5 x 2,5 mm	18 cm
11-851	11-863	11-876	2,0 x 3,0 mm	18 cm
11-852	11-864	11-877	3,0 x 4,0 mm	18 cm
11-853	11-865	11-878	4,0 x 5,0 mm	18 cm
11-854	11-866	11-879	5,0 x 5,0 mm	18 cm
11-855	11-867	11-880	6,0 x 5,0 mm	18 cm
		11-881	7,0 x 6,0 mm	18 cm
		11-882	2,0 x 2,0 mm	20 cm
11-856	11-868	11-883	2,5 x 2,5 mm	20 cm
11-857	11-869		2,0 x 3,0 mm	20 cm
11-858	11-870	11-884	3,0 x 4,0 mm	20 cm
11-859	11-871	11-885	4,0 x 5,0 mm	20 cm
11-860	11-872	11-886	5,0 x 5,0 mm	20 cm
11-861	11-873	11-887	6,0 x 5,0 mm	20 cm
		11-888	7,0 x 6,0 mm	20 cm
		11-889	2,0 x 2,0 mm	22 cm
		11-890	2,5 x 2,5 mm	22 cm
		11-891	2,0 x 3,0 mm	22 cm
		11-892	3,0 x 4,0 mm	22 cm
		11-893	4,0 x 5,0 mm	22 cm
		11-894	5,0 x 5,0 mm	22 cm
		11-895	6,0 x 5,0 mm	22 cm
		11-896	7,0 x 6,0 mm	22 cm
		11-897	2,0 x 2,0 mm	25 cm
		11-898	2,0 x 3,0 mm	25 cm
		11-899	3,0 x 4,0 mm	25 cm
		11-900	4,0 x 5,0 mm	25 cm
		11-901	5,0 x 5,0 mm	25 cm
		11-902	2,0 x 2,0 mm	30 cm
		11-903	2,0 x 3,0 mm	30 cm
		11-904	3,0 x 4,0 mm	30 cm
		11-905	4,0 x 5,0 mm	30 cm
		11-906	5,0 x 5,0 mm	30 cm

Maulgrößen Jaw sizes:

- 2,0 x 2,0 mm
- 2,5 x 2,5 mm
- 2,0 x 3,0 mm
- 3,0 x 4,0 mm
- 4,0 x 5,0 mm
- 5,0 x 5,0 mm
- 6,0 x 5,0 mm
- 7,0 x 6,0 mm

* Lengths are measured with closed jaws

Laminektomiestanzen
Pinces emporte-pieces a laminectomie

Pinzas cortantes para laminectomia
Pinze taglienti per laminectomia

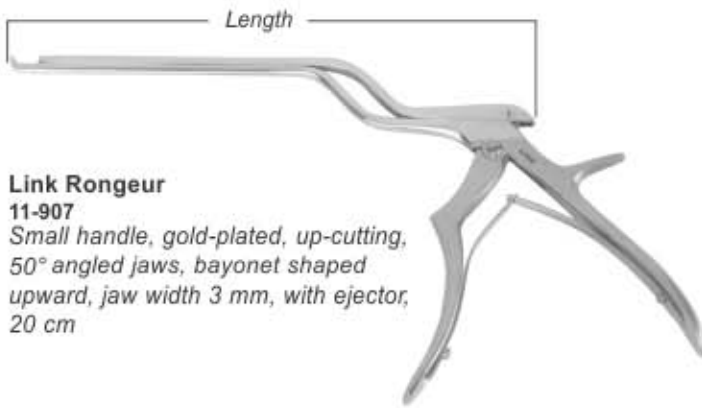

Link Rongeur
11-907
Small handle, gold-plated, up-cutting, 50° angled jaws, bayonet shaped upward, jaw width 3 mm, with ejector, 20 cm

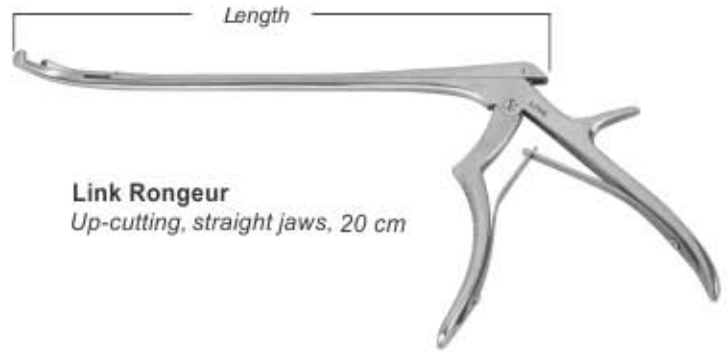

Link Rongeur
Up-cutting, straight jaws, 20 cm

Curved to left	Curved to right	Jaw size (width x height)
		3,0 x 4,0 mm
11-908	11-911	4,0 x 4,0 mm
11-909	11-912	5,0 x 4,0 mm
11-910	11-913	

Lengths are measured with closed jaws

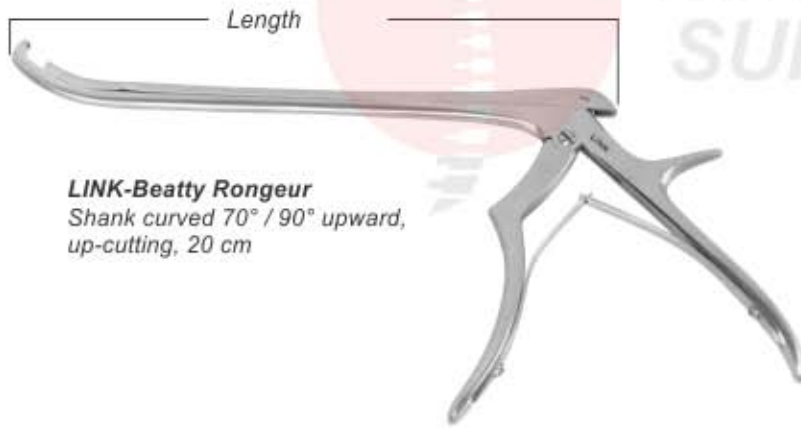

LINK-Beatty Rongeur
Shank curved 70° / 90° upward, up-cutting, 20 cm

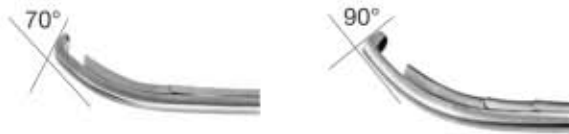

		Jaw size (width x height)
11-914	11-918	2,0 x 3,0 mm
11-915	11-919	3,0 x 4,0 mm
11-916	11-920	4,0 x 4,0 mm
11-917	11-921	5,0 x 4,0 mm

Lengths are measured with closed jaws

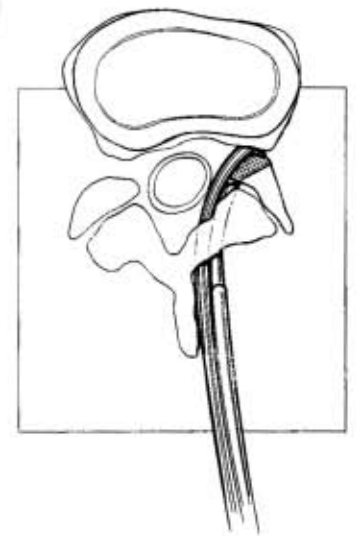

The angled LINK-Beatty Rongeur allows to perform foraminotomies while preserving dorsal processes and facet joints.

MANZIM
SURGICO

Laminektomiestanzen



Pinzas cortantes para laminectomia

Pinces emporte-pieces a laminectomie

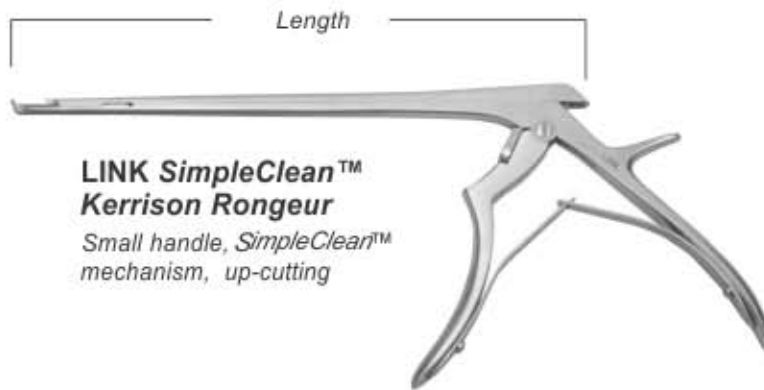
Pinze taglienti per laminectomia



**LINK SimpleClean™
Kerrison Rongeur**
Small handle, SimpleClean™
mechanism, up-cutting

50° angled jaws thin footplate			50° angled jaws		
	Jaw width	Length*		Jaw width	Length*
11-922	2 mm	18 cm	11-934	2 mm	18 cm
11-923	3 mm	18 cm	11-935	3 mm	18 cm
11-924	4 mm	18 cm	11-936	4 mm	18 cm
11-925	5 mm	18 cm	11-937	5 mm	18 cm
			11-938	6 mm	18 cm
11-926	2 mm	20 cm	11-939	2 mm	20 cm
11-927	3 mm	20 cm	11-940	3 mm	20 cm
11-928	4 mm	20 cm	11-941	4 mm	20 cm
11-929	5 mm	20 cm	11-942	5 mm	20 cm
			11-943	6 mm	20 cm
11-930	2 mm	23 cm	11-944	2 mm	23 cm
11-931	3 mm	23 cm	11-945	3 mm	23 cm
11-932	4 mm	23 cm	11-946	4 mm	23 cm
11-933	5 mm	23 cm	11-947	5 mm	23 cm
			11-948	6 mm	23 cm

Lengths are measured with closed jaws



The SimpleClean™ mechanism makes cleaning of the Rongeurs an easy matter

To open the SimpleClean™ mechanism pull the handle, turn the release and lift up the pusher.

The coloured release help to recognize more easily the individual widths of the jaw.

Laminektomiestanzen
Pincas emporte-pieces a laminectomie

Pinzas cortantes para laminectomia
Pinze taglienti per laminectomia



40° UPWARD

Black Line[®] Kerrison Laminectomy Punch
40° UPWARD Jaw angle
with special titanium coating on surface
Bone ejector



40° UPWARD

Thin Footplate Kerrison Laminectomy Punch
40° UPWARD Jaw angle
Thin Footplate For cervical surgery

40° UPWARD JAW

18cm/7" Shaft	20cm/8" Shaft	23cm/9" Shaft	Bite Size
11-949	11-955	11-961	1mm
11-950	11-956	11-962	2mm
11-951	11-957	11-963	3mm
11-952	11-958	11-964	4mm
11-953	11-959	11-965	5mm
11-954	11-960	11-966	6mm

40° UPWARD JAW

18cm/7" Shaft	20cm/8" Shaft	Bite Size
11-967	11-972	2mm
11-968	11-973	3mm
11-969	11-974	4mm
11-970	11-975	5mm
11-971	11-976	6mm

A reduced footplate thickness useful for a restricted operating area

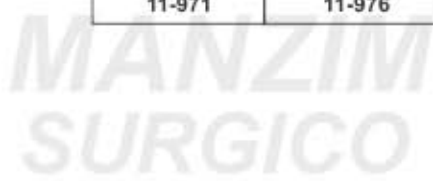

40° UPWARD



40° UPWARD



Ferris-Smith Kerrison Laminectomy Punch
40° UPWARD Jaw angle
Modified ring handle

40° UPWARD JAW

18cm/7" Shaft	20cm/8" Shaft	Bite Size
11-977	11-982	2mm
11-978	11-983	3mm
11-979	11-984	4mm
11-980	11-985	5mm
11-981	11-986	6mm

40° UPWARD JAW

28cm/11" Shaft	Bite Size
11-987	2mm
11-988	3mm
11-989	4mm
11-990	5mm
11-991	6mm

Long Anterior Kerrison Laminectomy Punch
40° UPWARD Jaw angle
with special Titanium coating on surface
Extra long shaft for Thoracic approach
Bone ejector

Brain Retractors Set

Conjunto de retractores cerebrales

Ensemble d'écarteurs cérébraux

Set di divaricatori per cervello



11-992
Book Walter Retractor
Complete Set with Box

MANZIM
SURGICO

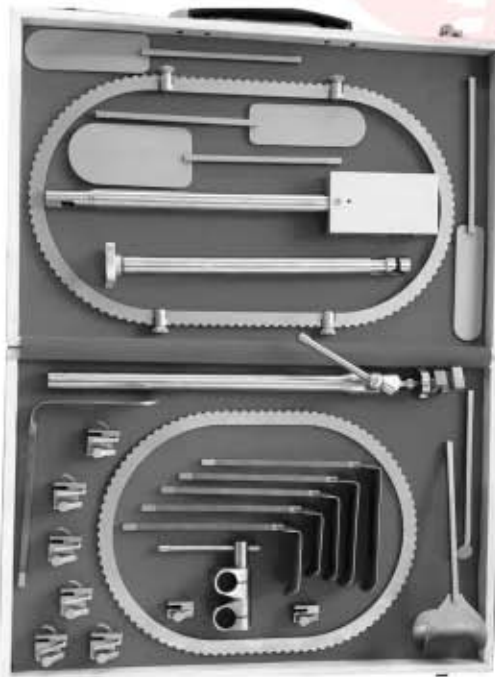

11-993
Book Walter Retractor
Complete Set with Wooden Box



11-994
Leyla
Self-Retaining Brain Retractor

CARDIOVASCULAR & THORACIC INSTRUMENTS



Krampfaderbesteck
Trousse a varices

Juego para varices
Astuccio per varici

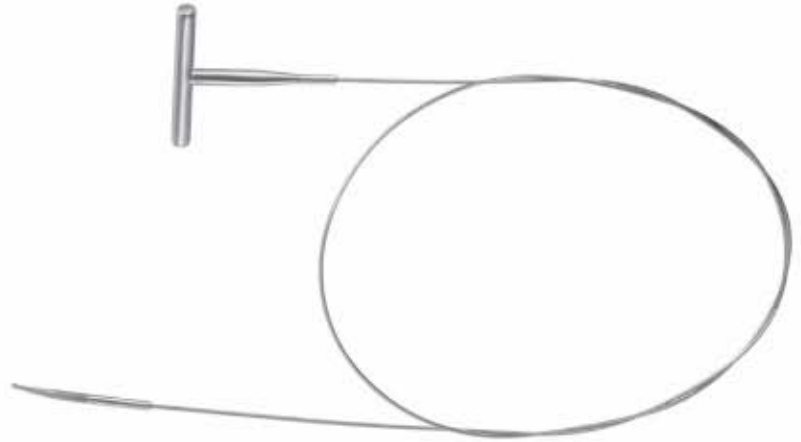

Nabatoff Varicose Vein Stripper

12-001
135mmx100mmx25mm

complete

12-002

Nabatoff

Metal Case

12-003

Nabatoff

Handle

12-004

Nabatoff

Cable 900mm

MANZIM
SURGICO



3mm



6mm



9mm



12mm

12-005

Nabatoff

Probe tip in plastic



Nabatoff
Metal Probe
12-006
3mm



Nabatoff
Metal Olive
12-007
6mm



Nabatoff
Metal Olive
12-008
9mm



Nabatoff
Metal Olive
12-009
12mm



Nabatoff
Metal Olive
12-010
15mm

Atrauma Mikro-Bulldogklemmen

Micro-Clamps Bulldog à mors Atrauma

Micro-Clamps Bulldog con bocas Atrauma

Attrae i morsetti Micro Bulldog



De Bakey

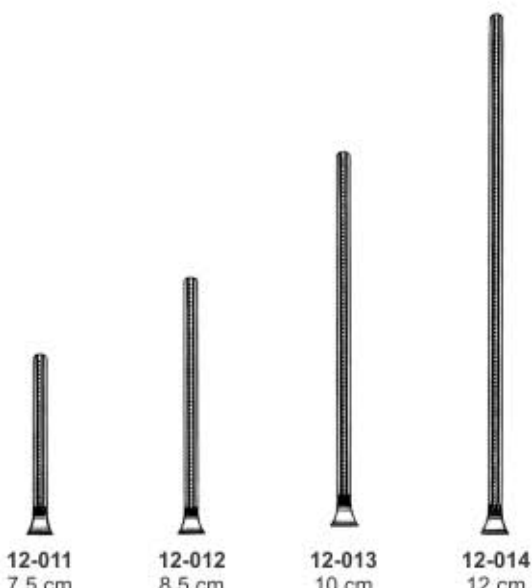

12-011
7.5 cm

12-012
8.5 cm

12-013
10 cm

12-014
12 cm



De Bakey

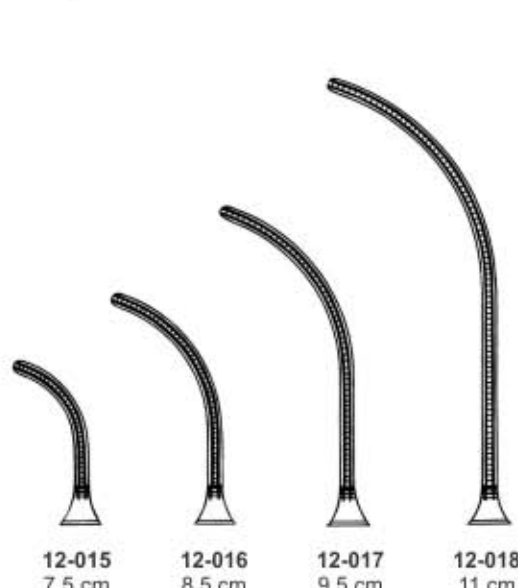

12-015
7.5 cm

12-016
8.5 cm

12-017
9.5 cm

12-018
11 cm



Glover



12-020
7 cm

12-021
8 cm

12-022
9.5 cm

12-023
11 cm



Glover

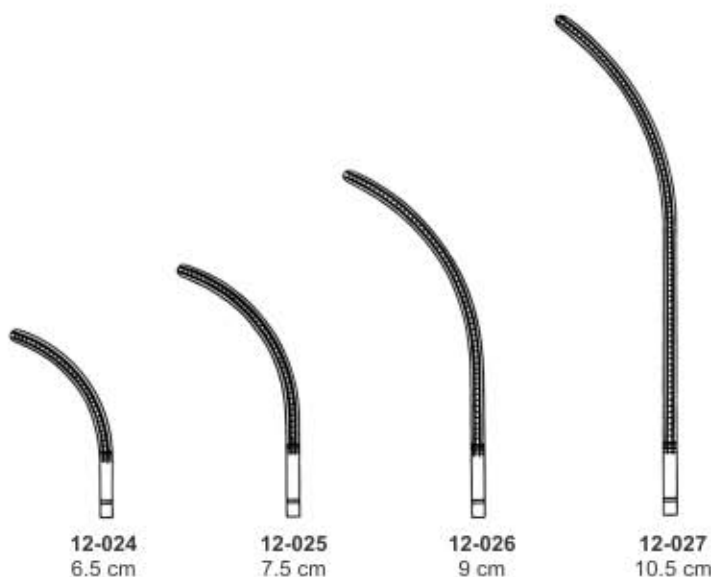

12-024
6.5 cm

12-025
7.5 cm

12-026
9 cm

12-027
10.5 cm

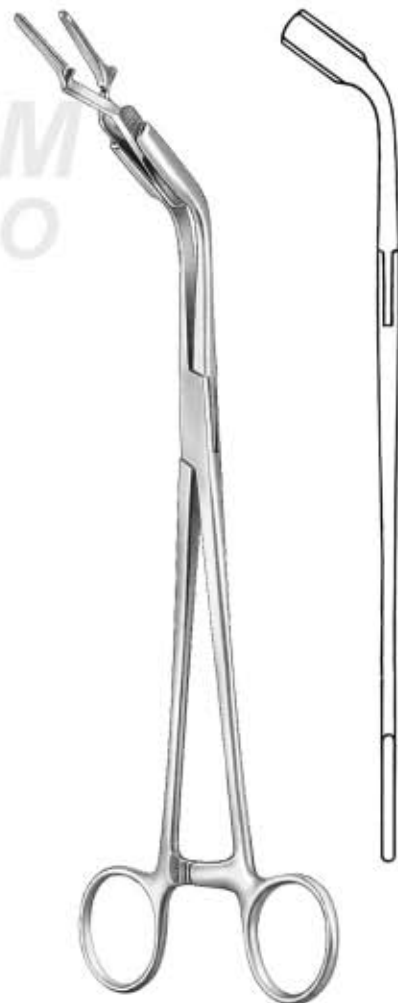

Applying forceps
for bulldog clamps
12-019
24 cm

Gefäßklemmen | Pinzas vasculares
Pinces vasculaires | Pinze vascolari



Hemostatic forceps



De Bakey-Rankin
16 cm



12-049
Straight



12-050
Curved



De Bakey-Mosquito
15 cm



12-051
Straight



12-052
Curved



Ochsner
12-053
22 cm



Diethrich
12-054
21 cm

MANZIM
SURGICO

COARCTATION CLAMPS

Coarctationsklemmen | Pincas-Clamps pour coarctation
 Pinzas para coarctación | Morsetti di Coartazione

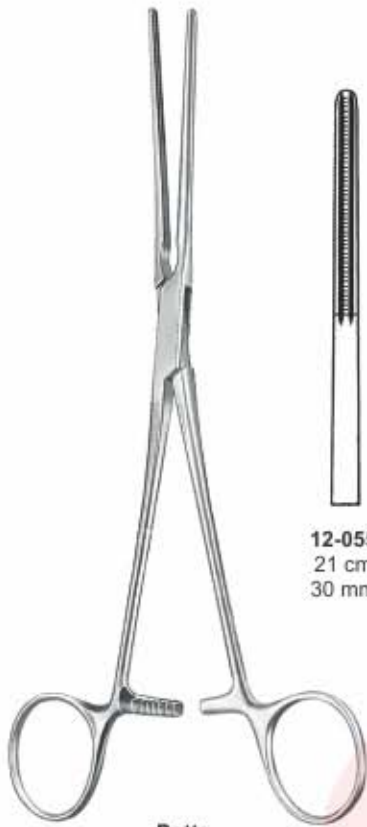

12-055
 21 cm
 30 mm

Potts



12-056
 22.5 cm
 55 mm



Potts



12-057
 20.5 cm
 angled
 30 mm



12-058
 22 cm
 angled
 55 mm



Potts

12-059
 20.5 cm
 angled
 30 mm



12-060
 22 cm
 angled
 55 mm



Potts
12-061
 21.5 cm
 55 mm

Anastomosenklemmen, Ligaturklemmen

Pinces-clamps à anastomose, Pinces à ligatures

Pinzas para anastomosis, Pinzas para ligaduras

Morsetti per anastomosi, pinze per legature



Potts
12-062
22 cm
55 mm



De Bakey



12-063
19 cm



12-064
24 cm



De Bakey
12-065
16 cm



De Bakey
12-066
19 cm

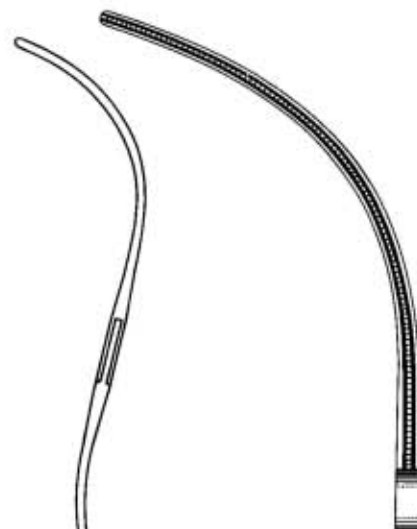

Peripheral-Gefäßklemmen
Pinzas para vasos periféricos

Pinces-clamps vasculaires périphériques
Morsetti vascolari periferici

Multi purpose Vascular Clamps



De Bakey
12-067
20 cm

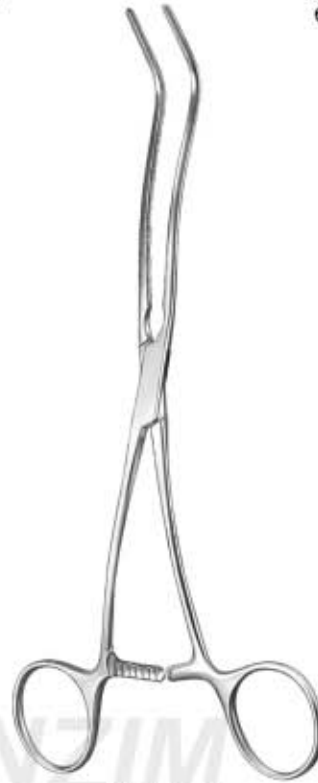

De Bakey
12-068
angled, 20 cm



Leland-Jones



12-069
18 cm



12-070
19 cm



12-071
20 cm



Peripheral-Gefäßklemmen
Pinzas para vasos periféricos

Pinces-clamps vasculaires périphériques
Morsetti vascolari periferici

MULTI PURPOSE VASCULAR CLAMPS



Bainbridge



12-072
15 cm



12-073
18.5 cm



Bainbridge



12-074
15 cm



12-075
18.5 cm



De Bakey



12-076
26 cm



12-077
27 cm



12-078
31 cm



12-079
33 cm



MANZIM
SURGICO

TANGENTIAL OCCLUSION FORCEPS

Tangential-Verschlußklemmen | Pincès vasculaires pour occlusion tangentielle
 Pinzas tangentes de oclusión | Morsetti di occlusione tangenziale

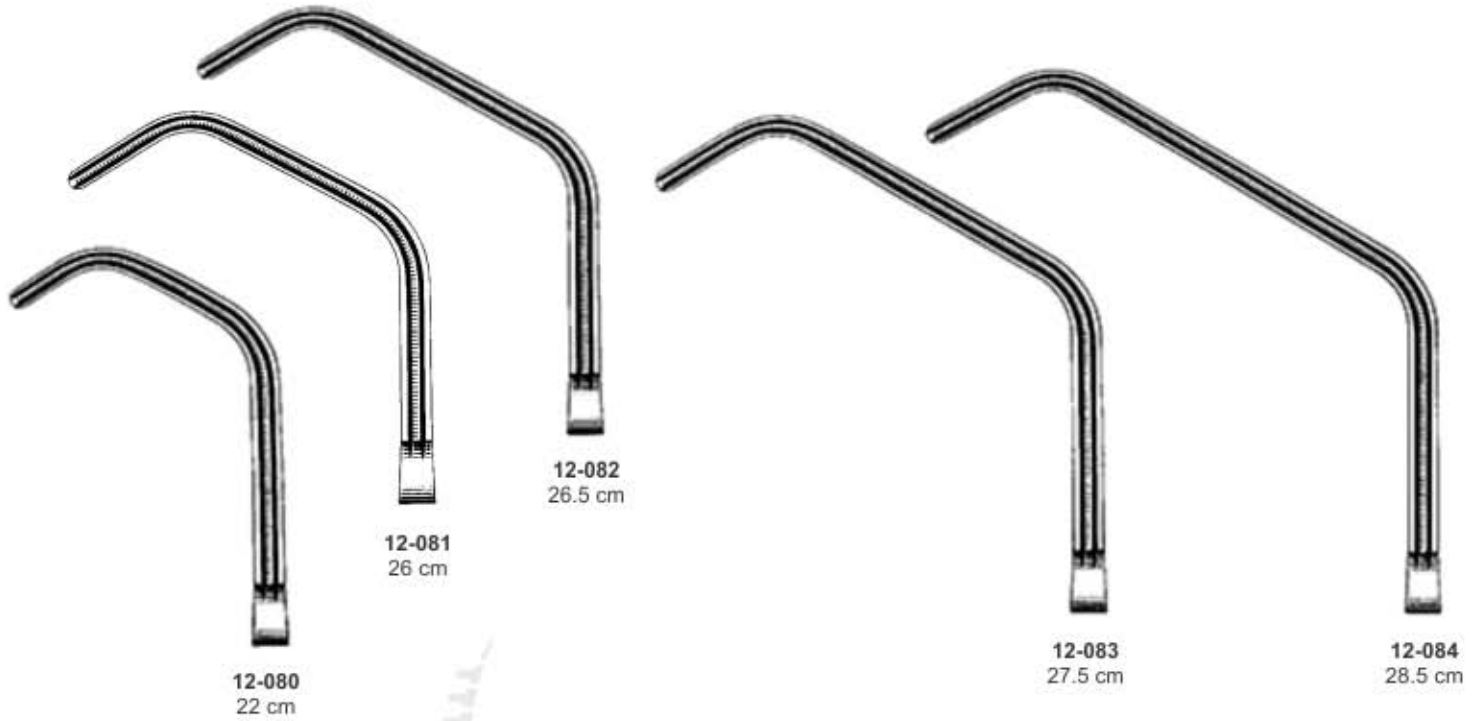

Aneurysm Clamps

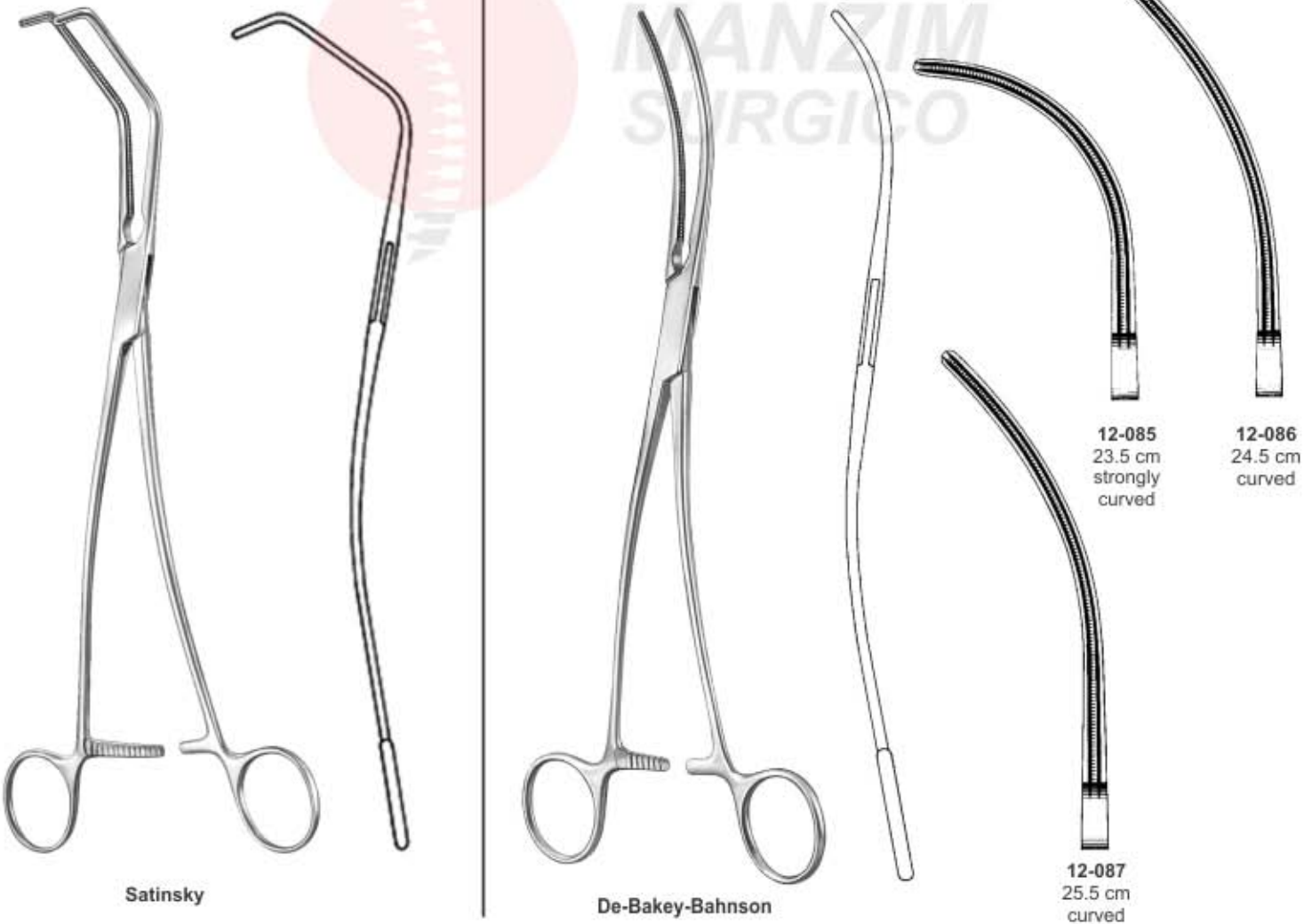

MULTI PURPOSE VASCULAR CLAMPS

Mehrzweck-Gefäßklemmen | Pincas vasculares universelles
Pinzas vasculares de usos múltiples | Morsetti vascolari multiuso

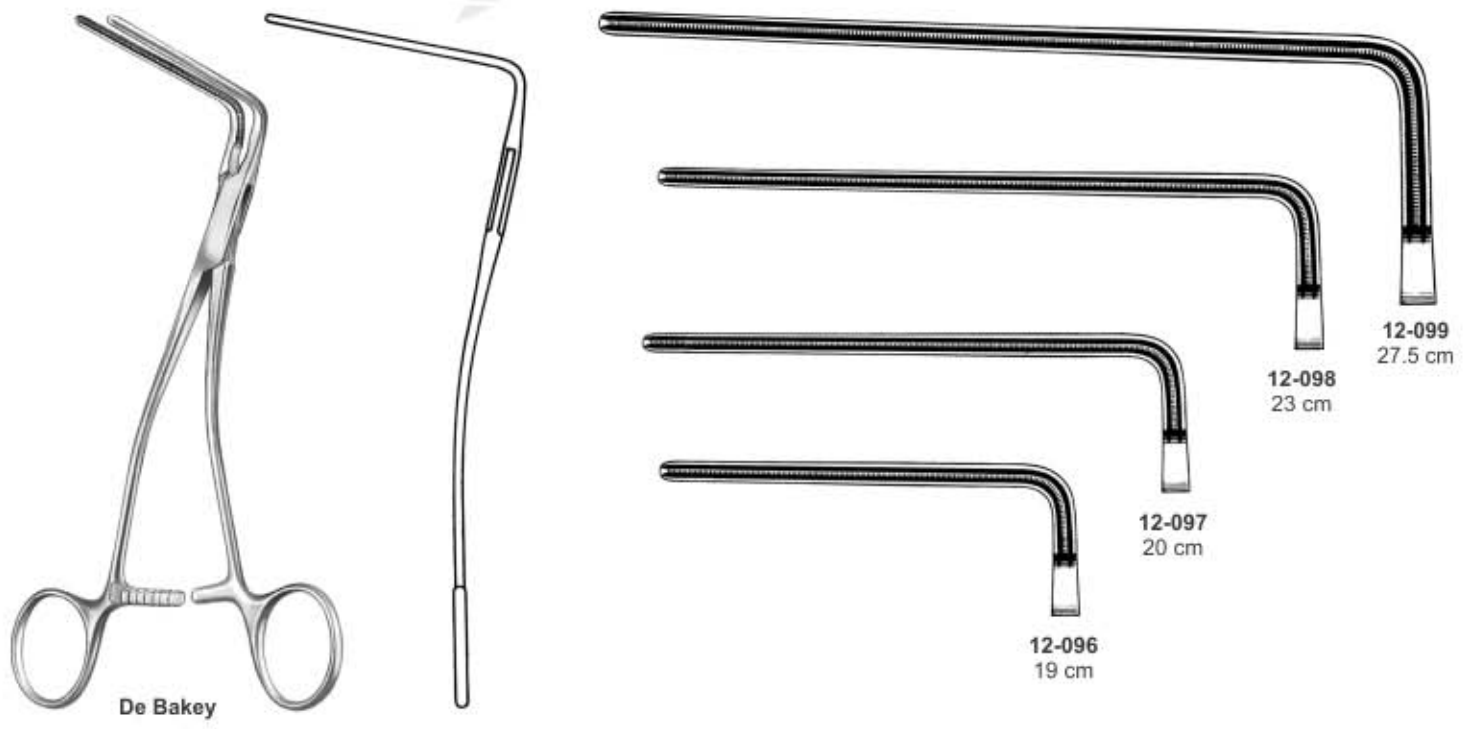

MULTI PURPOSE VASCULAR CLAMPS

Mehrzweck-Gefäßklemmen

Pinces vasculaires universelles

Pinzas vasculares de usos múltiples

Morsetti vascolari multiuso



De Bakey



12-100
21 cm

12-101
22 cm

12-102
26 cm

12-103
31.5 cm

MANZIM SURGICO



De Bakey
12-104
straight
17.5 cm



De Bakey



12-105
strongly
angled
15 cm



De Bakey Beck
12-106
17 cm

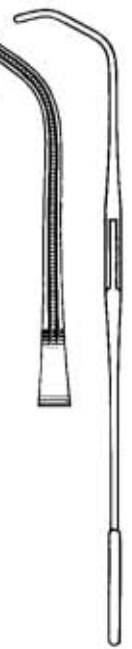

Anastomosis Clamps

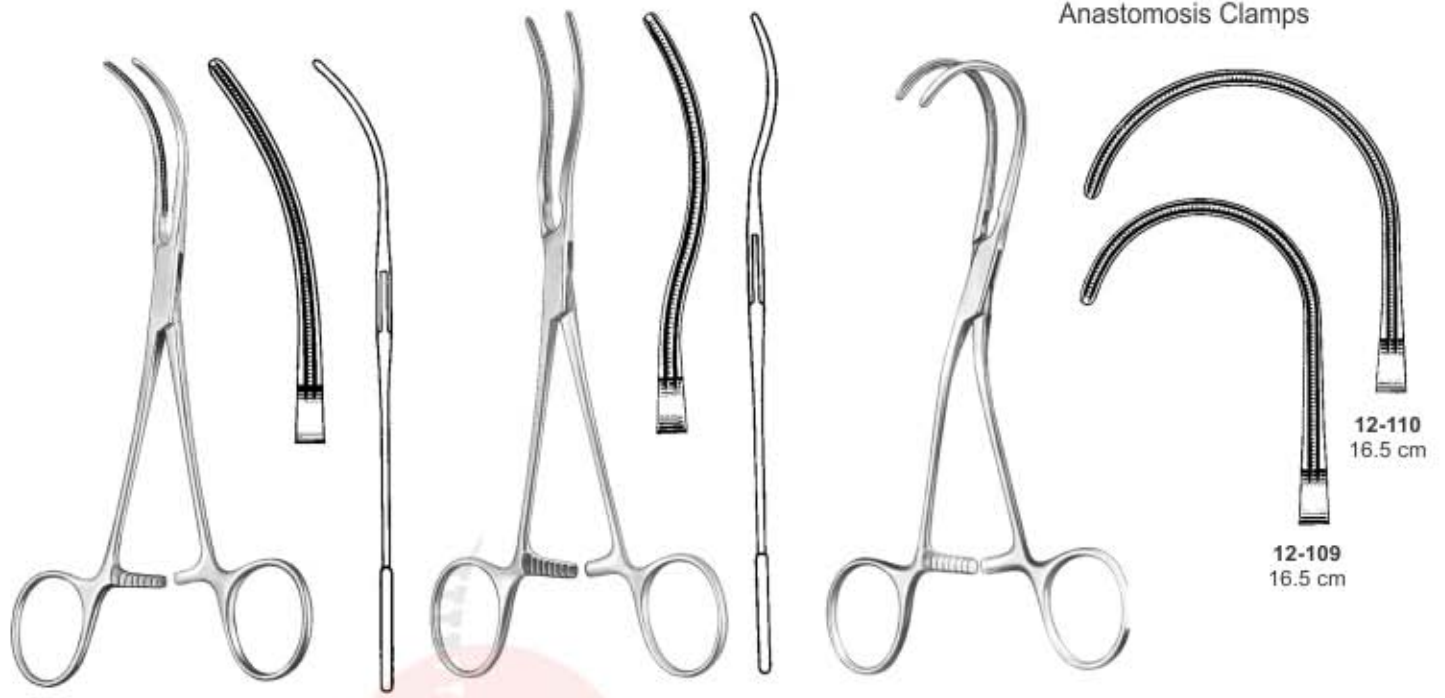

Glover
12-107
curved
17 cm

Glover
12-108
spoon-shape
17.5 cm

De Bakey

12-110
16.5 cm

12-109
16.5 cm



Derra

12-111
16.5 cm

12-112
17 cm

12-113
17.5 cm

Kinder-Gefäßklemmen

Pinces vasculaires pédiatriques

Pinzas vasculares pediátricas

Morsetti vascolari pediatrici

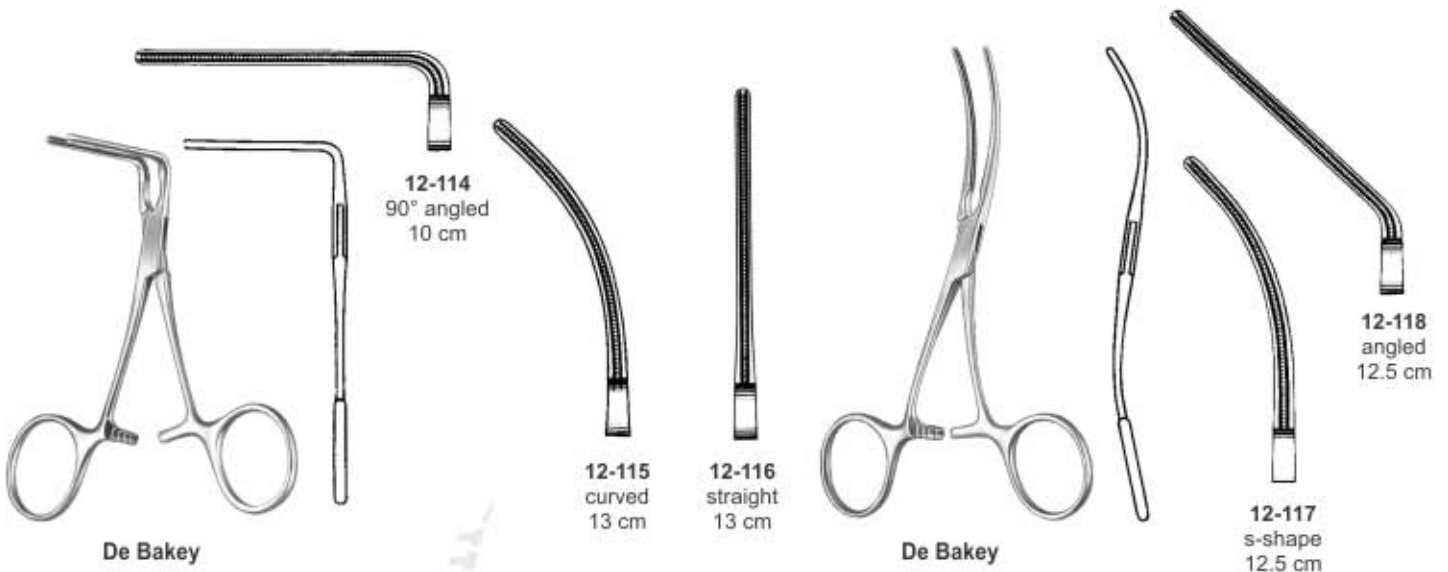

**MANZIM
SURGICO**

Anastomosis Clamps



Neonatal Vascular Clamps

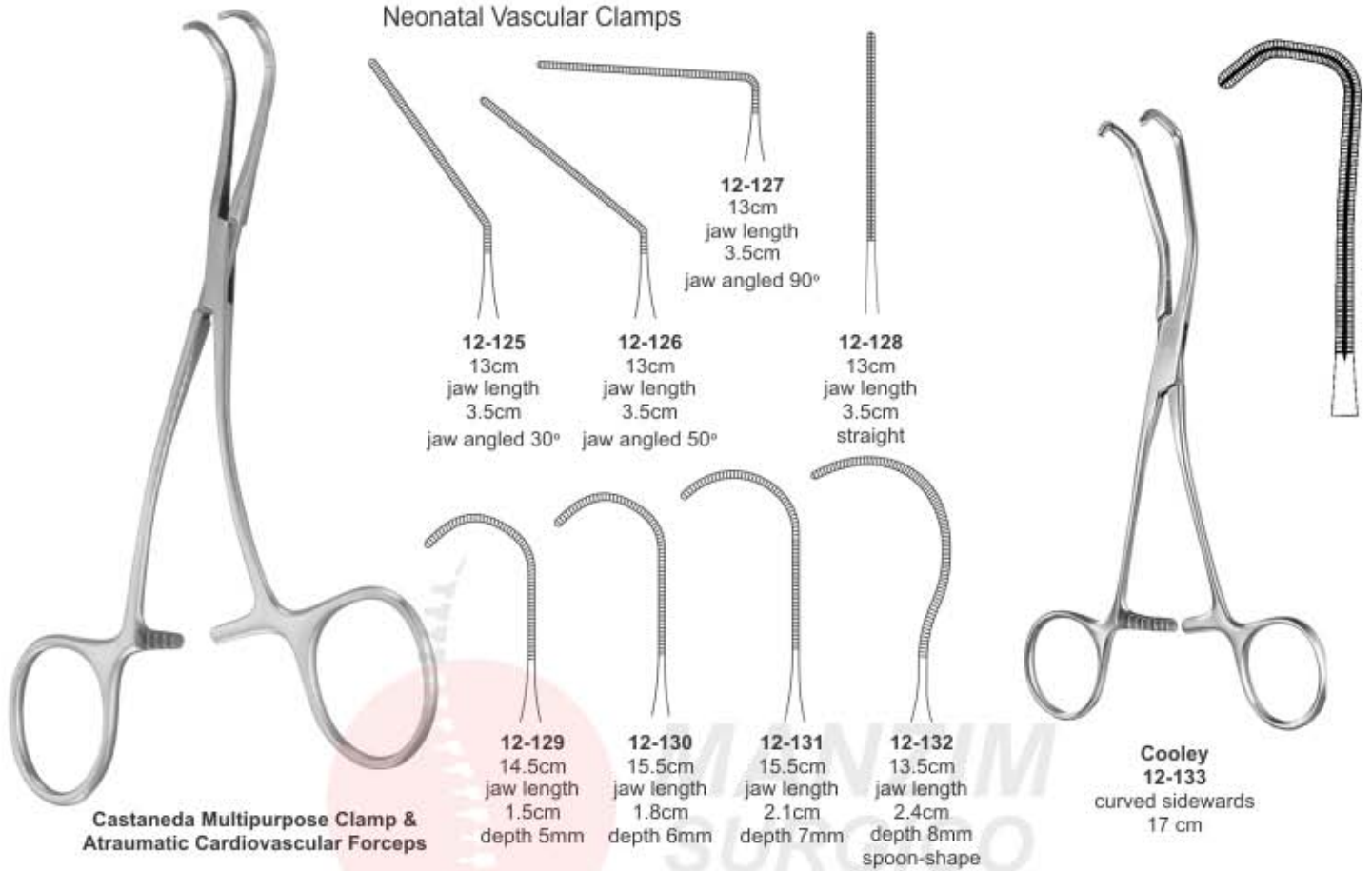

Rippenkontraktoren
Aproximadores para costillas

Rapprocheurs des côtes
Approssimatori costali



**Bailey-Gibbon
Rib Contractors
12-138
20 cm
For Adult**



**Bailey-Gibbon
Rib Contractors
12-139
20 cm
For children**



**Bailey-Baby
Rib Contractors
12-140
15 cm**



**Sellers Rib Contractor
12-141 20 cm**



**Blalock
Rib Contractors**

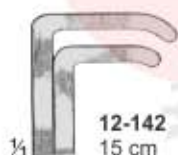

**12-142
15 cm**



**12-143
20 cm**



**12-144
20 cm**



**Johns-Hopkins
(Potts Modif.)
Rib Contractors**



**12-145
20 cm**



**12-146
20 cm**



**12-147
20 cm**

Lungenspatel, Aorta-Dilatatoren

Spatules pulmonaires, Dilatateurs pour aorte

Espátulas pulmonares, Dilatadores aórticos

Spatole per pulmone, Dilatatori per aorta



Allison Lung Spatula Retractor
 12-148 25 cm
 12-149 30 cm
 12-150 32 cm
 wide 3.8cm
 Small Size

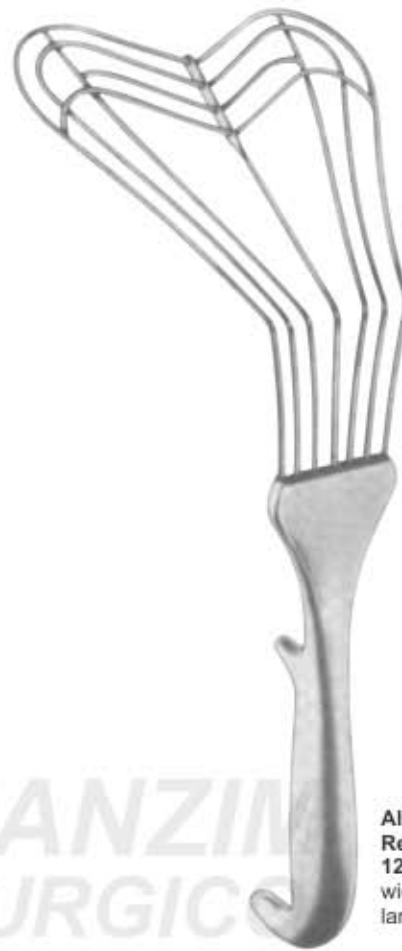

Allison Lung Spatula Retractor
 12-151 32.4 cm
 wide 5.2cm
 large size

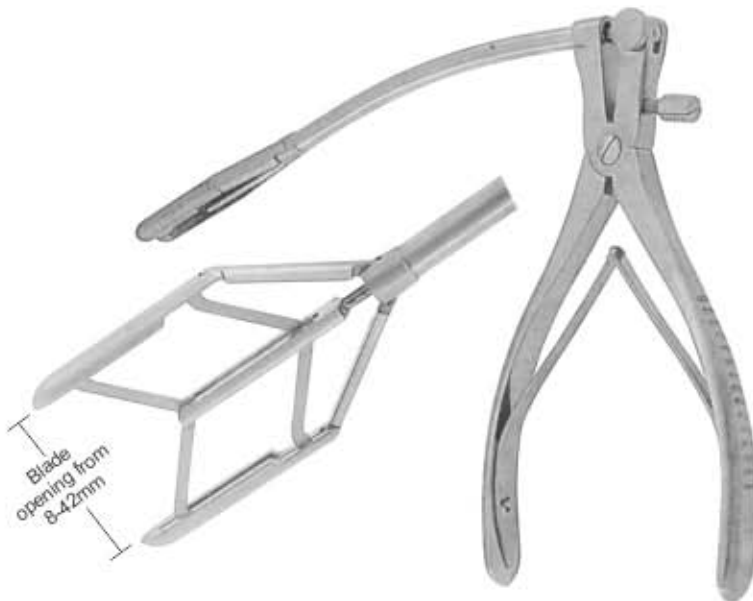

Tubbs Mitral Valve Aortic Dilator
 12-152
 Blade Opening
 From 8 To 42 mm



Cooley Blade Aortic Dilator
 12-153
 Blade Opening
 From 8 To 15 mm

Rippensperrer | Ecarteur de côtes
 Separador costal | Divaricatore costale



Morse 12-154
 Sternal Retractor 4 movable
 blades 22 x 27mm spreading 200 mm
 Size 1,



DeBaKey 12-155
 Rib Retractor spreading 150 mm
 Size 1,



DeBaKey 12-156
 Rib Retractor spreading 200 mm
 Size 1,



Cherry 12-157
 mm mm mm
 44 70 135



Cooley Rib Retractors 12-158
 lateral blades 12 x 16 mm spreading 95 mm



Cooley Rib Retractors
 12-159 lateral blades 15 x 30 mm, spreading 140 mm
 12-160 lateral blades 21 x 44 mm, spreading 150 mm



Cooley Rib Retractors
12-161

lateral blades 35 x 50 mm, spreading 200 mm

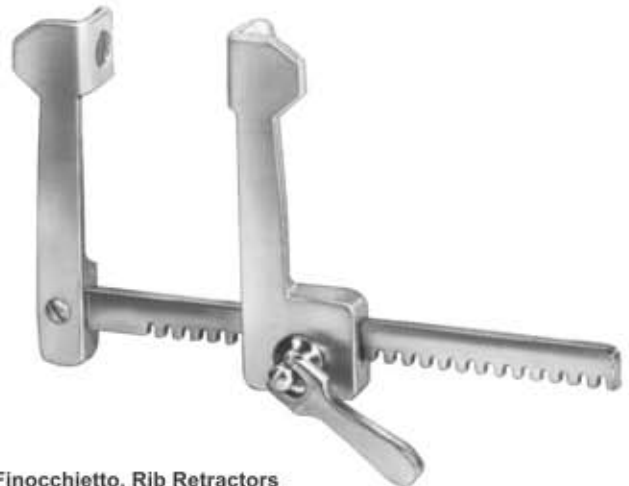

Finocchetto, Rib Retractors

- 12-162** lateral blades 15 x 15 mm, spreading 75 mm, infant
- 12-163** lateral blades 31 x 31 spreading 100 mm, baby - height
- 12-164** lateral blades 40 x 45 spreading 135 mm, baby - height
- 12-165** lateral blades 52 x 62 spreading 175 mm, baby - height
- 12-166** lateral blades 84 x 65 spreading 175 mm, baby - height



Haight Rib Retractor
12-167

lateral blades 30 x 30 mm, spreading 120 mm



Morse-Favaloro Sternal Retractor
12-168

4 movable blades 17 x 22 mm, spreading 160mm for children



Finocchetto (Modif.) Rib Retractors
12-169

lateral blades 14 x 15 mm, spreading 120 mm



Tuffier Rib Retractor

- 12-170** lateral blades 45 x 45 mm, spreading 160 mm
- 12-171** lateral blades 22 x 27 mm, spreading 200 mm

Rippensperrer | Ecarteur de côtes
 Separador costal | Divaricatore costale

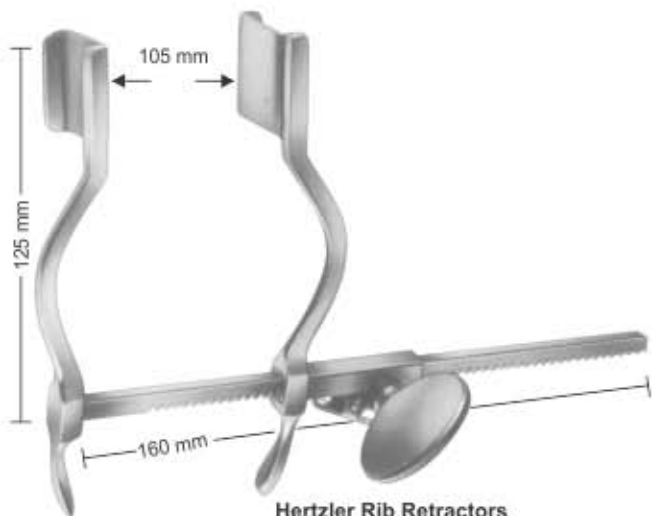

Hertzer Rib Retractors
12-172
 blades 20 x 25 mm, spreading 105 mm

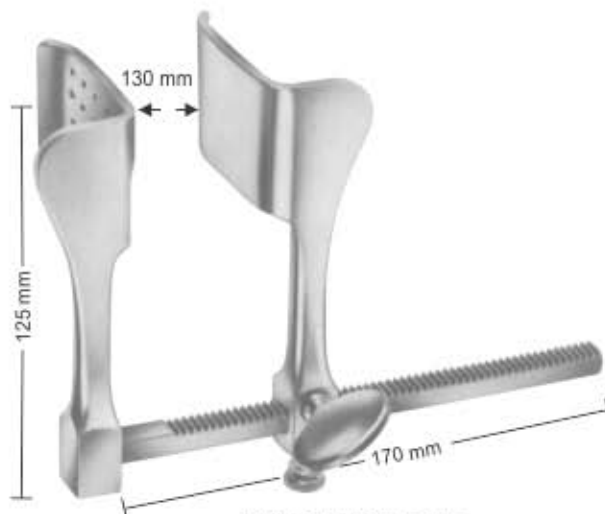

Tuffier Rib Retractors
12-173
 blades 43 x 53 mm, spreading 130 mm

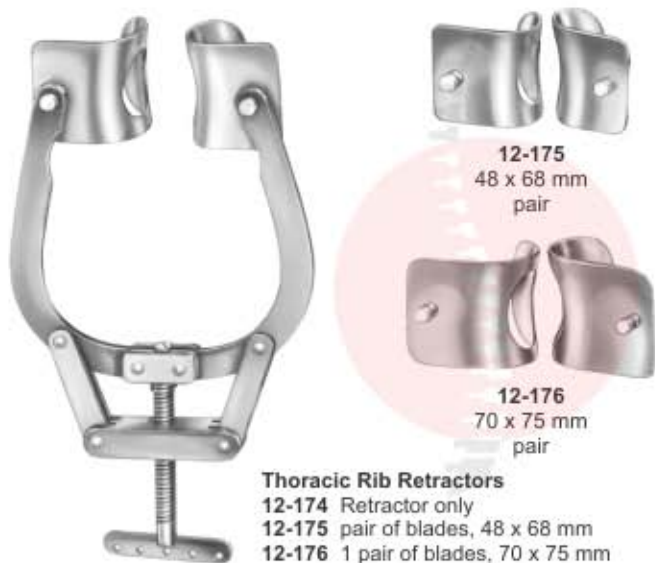

Thoracic Rib Retractors
12-174 Retractor only
12-175 pair of blades, 48 x 68 mm
12-176 1 pair of blades, 70 x 75 mm



Thoracic & I.M.A Rib Retractors
12-177 Complete set
12-178 lateral blades for I.M.A Retractor
 left 40 x 50 x 80 mm
12-179 lateral blades for I.M.A Retractor
 Right 40 x 50 x 80 mm

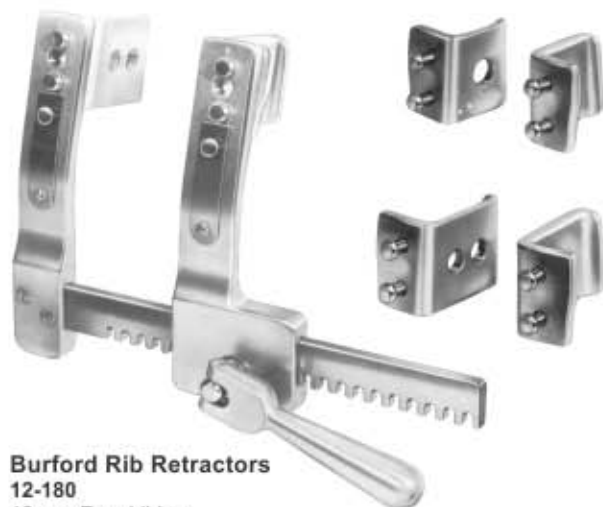

Burford Rib Retractors
12-180
 18 cm For children
 spread with 2 sets of Blades
12-181 48 mm x 42 mm spreading 135 mm
12-182 38 mm x 42 mm spreading 135 mm



Burford Rib Retractors
12-183
 18 cm For Adults
 spread with 2 sets of Blades
12-184 with two pair of blade 47 x 62 mm + 65 x 62 mm spreading 200 mm
12-185 with 2 pair of blade 47 x 62 mm + 65 x 62 mm spreading 260 mm
12-186 with 2 pair of blade 47 x 62 mm + 65 x 62 mm spreading 300 mm

Rippensperrer
Separador costal

Ecarteur de côtes
Divaricatore costale

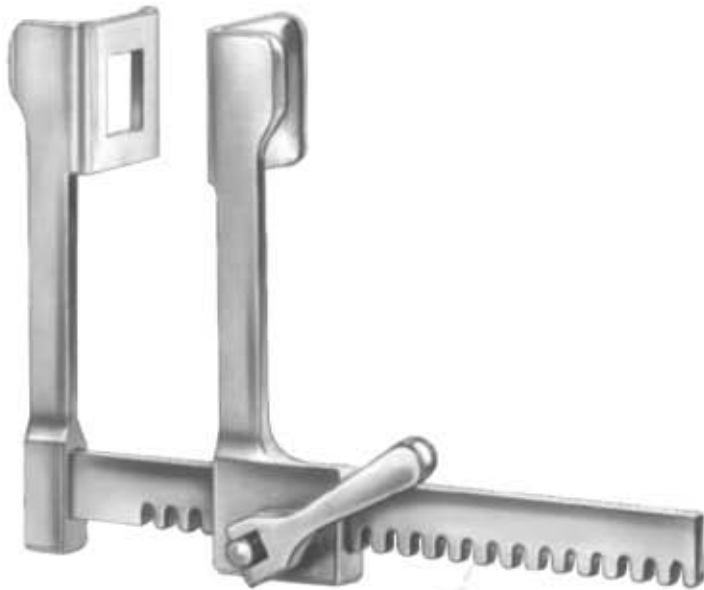

Finocchietto/Baby Rib Retractors
12-187 7.5 cm
14 mm x 15 mm spreading 75 mm



Finocchietto, Rib Retractors
20 cm
12-188 30 mm x 45 mm spreading 150 mm
12-189 46 mm x 62 mm spreading 190 mm
12-190 80 mm x 65 mm spreading 190 mm



Castaneda Rib Retractors
12-191 10.5 mm x 32 mm
spreading 65 mm



Castaneda Rib Retractors
12-192 12 mm x 45 mm
spreading 70 mm



Castaneda Rib Retractors
12-193 15 mm x 60 mm
spreading 120 mm

RIB SHEARS, STERNUM CHISEL

Rippenscheren, Sternummeißel
Costotomos, Cinceles

Costotomes, ciseau-Burin à sternum
Costotomi, Scalpello per sterno



Sauerbruch-Frey Rib Shears
12-194
for the first rib
37 cm



Schumacher Rib Shears
12-195
sternum shears
21 cm



Bone Rib Shear
12-196
23 cm



Rib Shear
12-197
23 cm



Gluck Rib Shear
12-198
22 cm



Lebsche Sternum Chisel
12-199 24.5 cm



Semb Rib Shears
12-200 20 cm



Semb Rib Shears
12-201 20 cm

Rippenscheren, Sternummeißel
Costotomos, Cinceles

Costotomes, ciseau-Burin à sternum
Costotomi, Scalpello per sterno

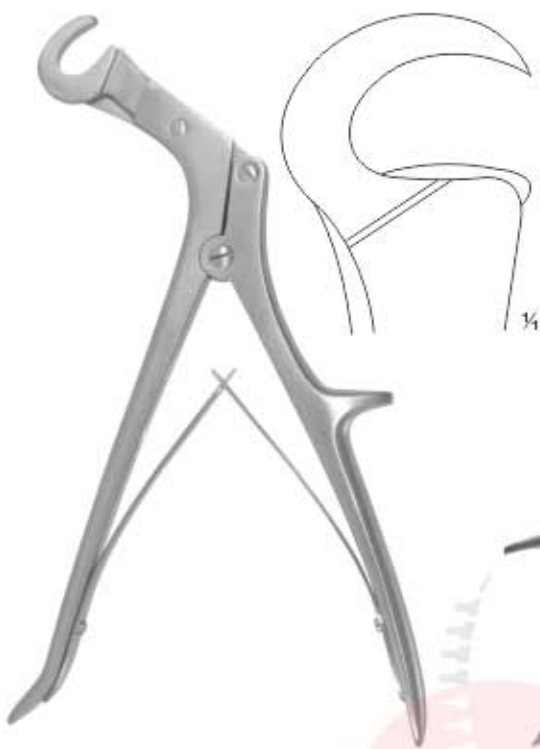

Giertz-Stille Rib Shears
12-202 27 cm

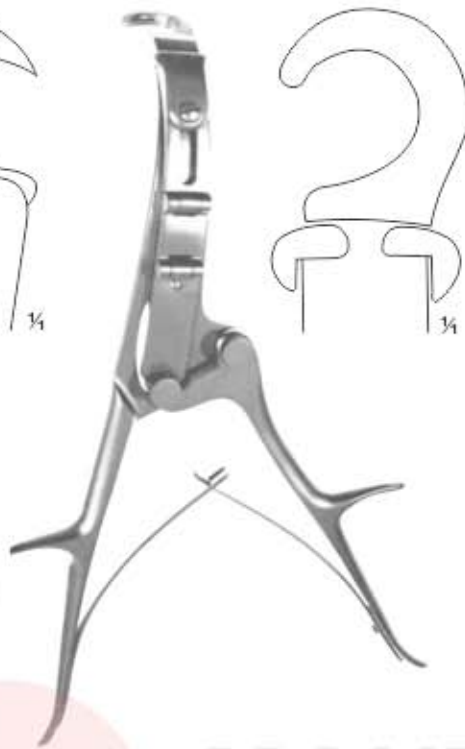

Brunner Rib Shears
12-203 33.5 cm



12-204
Hooked Left
23 cm



12-205
Hooked Right
23 cm

Maurer-Collin Rib Shears



Sauerbruch Rib Shears
12-206 24 cm, For Children
12-207 27 cm, For Adults



Schuardt Rib Shears
12-208 17 cm



Collin Rib Shears
12-209 19 cm



Doyen Rib Shears
12-210 19 cm



OPHTHALMIC INSTRUMENTS



Micro Forceps



Chalazion Clamp
13-001
11cm



Chalazion Forceps
13-002
Oval 12 X 14mm, 10 cm long



13-003
Round 8mm,
10 cm long



13-004
Round 15mm,
10 cm long



13-005
Oval 17 X 9mm,
10 cm long



Chalazion Forceps
13-006



Cauer
13-007
10 cm
Chalazion Forceps



Suture Tying Forceps
13-008 9cm
13-009 11cm



McPherson Forceps
13-010 9cm
13-011 11cm

MANZIM
SURGICO



Corneal Forceps
1x2 (0.12)
13-012 9cm
13-013 11cm



Bonn Forceps
13-014
11cm



Utrata
Capsulorhexis
Forceps
13-015 11cm
Curved



Utrata
Capsulorhexis
Forceps
13-016 11cm
Straight



Colibri Forceps
1x2 (0.12)
13-017



Holding & Folding
Forceps
for Acrylic Lenses
13-018
11cm



Holding & Folding
Forceps
for Acrylic Lenses
13-019
11cm



Morefeld Forceps
13-020
11cm

Round Handle Available



Suture Tying Forceps
13-021 9cm
13-022 11cm

Round Handle Available



McPherson Forceps
13-023 9cm
13-024 11cm



Corneal Forceps
1x2 (0.12)
13-025 9cm
13-026 11cm



Bonn Forceps
13-027 9cm
13-028 11cm



Utrata Capsulorhexis Forceps
13-029 9cm
13-030 11cm
Curved



Utrata Capsulorhexis Forceps
13-031 9cm
13-032 11cm
Straight



Holding & Folding Forceps
for Acrylic Lenses
13-033 9cm
13-034 11cm



Holding & Folding Forceps
for Acrylic Lenses
13-035 9cm
13-036 11cm



Colibri Forceps
with tying platform
13-037



Gerl
Tying Forceps
curved shanks
6mm long platform
For 8-0 to 11-0 sutures.
titanium
13-038



Tennant
Tying Forceps
extra delicate smooth jaws
with 6mm long platform
round handle with guide pin
For 9-0 to 11-0 sutures.
13-039 straight
13-040 straight, titanium
13-041 curved
13-042 curved, titanium



Self-Retaining
Retractors



13-043
10 cm
sharp



13-044
10 cm
blunt



Berke
13-045
11 cm
Ptosis Forceps



Förster
13-046
10 cm
Conjunctiva
Forceps



Fechtner Conjunctiva
Forceps
13-047 11 cm long
Very delicate ring tips,
with tying
platforms



Scleral Plug Forceps
13-048
Designed to securely
hold scleral plugs during
insertion and removal.
The cross-action handle
reduces hand fatigue
while grasping plug,
11.5 cm long

Round Handle Available



13-050

McPherson
Forceps
13-049



13-052

Suture Tying
Forceps
13-051



13-054

Utrata Capsulorhexis
Forceps
13-053



13-056

Corneal Forceps
1x2 (0.12)
13-055



Colibri
Forceps
extra delicate
1x2 teeth, 0.12mm
with tying platform
13-057



13-058
Cooley
18 cm



13-059
Castroviejo TC
18cm



13-060
Noyes Micro Scissors
CVD 18cm



Needle Holder
delicate, curved, without lock,
overall length: 115mm, titanium
Ideal for 9-0 to 10-0 sutures
13-061 with lock
13-062 without lock
13-063 titanium, with lock
13-064 titanium, without lock



Barraquer
Needle Holder
delicate jaws, straight
13-065 with lock
13-066 without lock
13-067 titanium, with lock
13-068 titanium, without lock

MANZIM
SURGICO

Micro Scissors



IOL Holding Forceps
13-069 11.5cm



Micro Needle Holders
13-070 11.5cm



Corneal Scissors
13-071 11.5cm



Cephalotomy Scissors
13-072 11.5cm



MANZIM
SURGICO



Vannas Scissors
13-073 11.5cm
Straight



Vannas Scissors
13-074 11.5cm
Curved



Westcott Scissors
13-075 11.5cm



Iris Scissors
13-076 11.5cm



**Vannas Scissors
13-077**

Sharp pointed tips. Curved 7.5mm blades, 9.5mm from pivot to tip, 8 cm long



**Vannas Scissors
13-078**

Sharp tips. Angled to side 7mm blades, 9mm from pivot to tip, 8 cm long



13-079



13-080



13-081



13-082



13-083



13-084



13-085

Capsulotomy Scissors Vannas

5mm long blades, sharp tips

13-079 straight

13-080 curved

13-081 angled forward

13-082 angled to side

Gills-Vannas

7mm long blades, sharp tips

13-083 straight

13-084 curved

13-085 angled forward

McPherson-Vannas

8mm long blades, sharp tips

13-086 curved



13-086

**MANZIM
SURGICO**



Barraquer

Needle Holder

delicate jaws, curved

13-087 with lock

13-088 without lock



McPherson

Needle Holder

very delicate jaws

13-089 with lock straight

13-090 without lock straight

13-091 with lock curved

13-092 without lock curved



Micro Needle Holder

Needle Holder

delicate jaws

strongly curved

13-093 with lock

13-094 without lock



Castroviejo

Needle Holder

delicate jaws, curved

13-095 with lock

13-096 without lock



Castroviejo

Needle Holder

standard jaws

straight, with lock

13-097

13-098 TC Tungsten Tip



Kalt

Needle Holder

delicate smooth jaws

straight, with lock

13-099



Micro Incision Forceps
13-100



Micro Incision Scissors
13-101



Endothelial Grasping Forceps
curved, 23 gauge
delicate end-gripping
platforms jaws 90°
off-set from "squeeze handle"
mechanism
13-102



Vitreoretinal Forceps
Lens Cartridge
Loading Forceps
straight, 20 gauge
13-103



Scissors
horizontal opening
straight
13-104



Scissors
horizontal opening
angled 60°
13-106



Scissors
horizontal opening
angled 30°
13-105



Scissors
horizontal opening
angled 80°
13-107

Vitreotomy Scissors
T20 gauge shank
Stainless steel
construction with
flat handle.
Autoclavable.



Troutman-Castroviejo
delicate patterns, with stop



13-108
10,5 cm
right

13-109
10,5 cm
left



Wecker
13-110
11 cm
pointed-pointed

MANZIM SURGICO

Cannulas



Sterilizing Boxes (with silicon Pads)





Curette
13-124



Wire Vectus
13-125



Strabismus Hook
13-126



Lense Expressor
13-127



Bimanual Hand Irrigation
13-128



Bimanual Hand Aspiration
13-129



Rosen
Phco Splitter
60° angled wedge
shaped inferior edge
with blunt tip
13-130
Titanium



Nagahara
Chopper
13-131



Sinskey
Hook
13-132



Sinskey
Hook
13-133



Nagahara
Chopper
13-134



Lachrymal Dilator
Double Ended
13-135



Lachrymal Dilator
13-136 Fine Taper
13-137 Medium Taper
13-138 Heavy Taper



Lachrymal Probes
13-139





Barrquer Wire Speculums
13-159
heavy wire, 15mm blades



Barrquer Solid Blade
Wire Speculum
13-160
Barrquer, 10mm blades



Kratz - Barrquer
Wire Speculum
15mm blades
one solid and one open wire
13-161
for right eye



Kratz - Barrquer
Wire Speculum
15mm blades
one solid and one open wire
13-162
left eye



Wire
Speculums
13-163

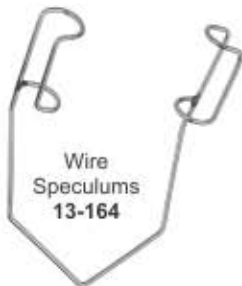

Wire
Speculums
13-164

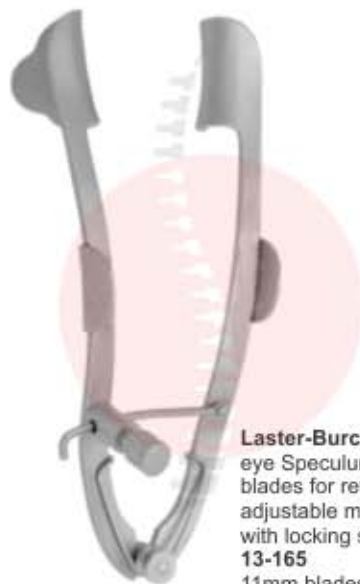

Laster-Burch Speculum
eye Speculum with flanges on
blades for retaining eye lashes
adjustable mechanism
with locking screw
13-165
11mm blades



Lieberman
Speculum
13-166



Clark
Speculums
13-167



Jameson
Caliper chrome
plated
13-168



Braunstein Caliper
3.5/4.0mm
Stainless Steel
13-169



13-170
Calliper
Fixed



Fixed
Caliper
13-171



Castroviejo Caliper
20mm spread
13-172 straight
13-173 angled
13-174 curved



Maloney
Intra-Operative
Keratometer titanium
For qualitative
measurement
of astigmatism.
13-175

ENT SURGERY



Ohrspekulum

Espéculo de oreja

Spéculum auriculaire

Speculum auricolare



14-001
4.5 mm Ø



14-002
5.5 mm Ø



14-003
6.5 mm Ø



14-004
7.5 mm Ø



14-007
2 mm Ø



14-008
3 mm Ø



14-009
4 mm Ø



14-010
5 mm Ø



Toynbee Ear Speculum
3.6 cm 1 1/2"
Set for adults

14-005
Set of 3
5.5 mm
6.5 mm
7.5 mm

14-006
Set of 4
4.5 mm
5.5 mm
6.5 mm
7.5 mm



Politzer Ear Speculum
Set for adults

14-011
Set of 3
2 mm
3 mm
4 mm

14-012
Set of 4
2 mm
3 mm
4 mm
5 mm



Gruber Ear Speculum
Set for adults



14-013
a - 4.5 mm Ø



14-014
a - 5.5 mm Ø



14-015
a - 6.5 mm Ø



14-016
a - 7.5 mm Ø



Gruber Ear Speculum
Set for adults



14-017
a - 4.5 mm Ø



14-018
a - 5.5 mm Ø



14-019
a - 6.5 mm Ø



14-020
a - 7.5 mm Ø



14-021
4.5 mm Ø



14-022
5.5 mm Ø



14-023
6.5 mm Ø



14-024
7.5 mm Ø



Boucheron Ear Speculum
Set for adults



14-025
3 mm Ø



14-026
4.5 mm Ø



14-027
5.5 mm Ø



Boucheron Ear Speculum
Set for children

EAR SPECULUM

Ohrspekulum | *Espéculo de oreja*
Spéculum auriculaire | *Speculum auricolare*



Hartmann Ear Speculum
for children



Hartmann Ear Speculum
Set for adults



Zollner Ear Speculum
Set for adults, Black

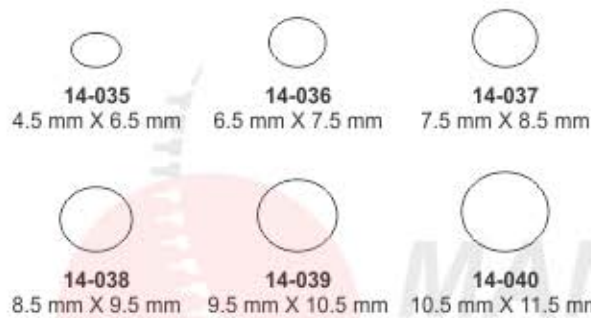

Hartmann Ear Speculum
Set for adults, Black



Gruber Aural Specula Ear Speculum
Black finish, 38 mm Ø
14-046 Set of 4
14-047 3 mm
14-048 4 mm
14-049 5 mm
14-050 7 mm



Rosen Ear Speculum
Black finish, Slotted round ends 35 mm Ø
14-051 Set of 4
14-052 3 mm
14-053 4 mm
14-054 5 mm
14-055 7 mm

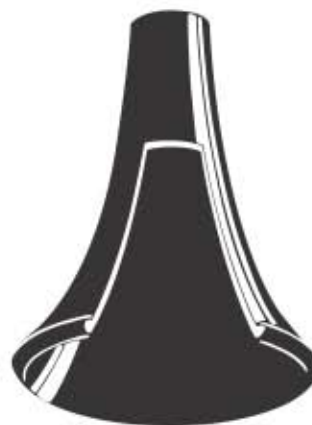

Rosen Ear Speculum
slotted round ends
Black finish, 35 mm Ø
14-056 Set of 4
14-057 4 mm
14-058 5 mm
14-059 6 mm
14-060 7 mm

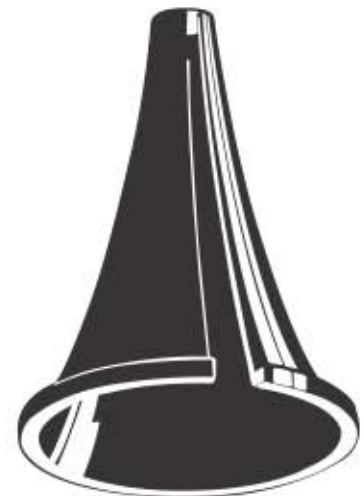

Tumarkin Ear Speculum
Tapered slot set of 8
14-061 4.5 mm
14-062 6.5 mm
14-063 7.0 mm
14-064 7.5 mm
14-065 8.0 mm
14-066 8.5 mm
14-067 9.0 mm
14-068 11 mm

<i>Ohrspekulum</i>	<i>Especulo de oreja</i>
<i>Spéculum auriculaire</i>	<i>Speculum auricolare</i>



14-069
6.5 mm Ø



14-070
7 mm Ø



14-071
8 mm Ø

Siegle Magnifier Ear Speculum
14-072
Complete Set
with 3 Ear Specula & Otoscope



**Siegle Magnifier
Otoscope**

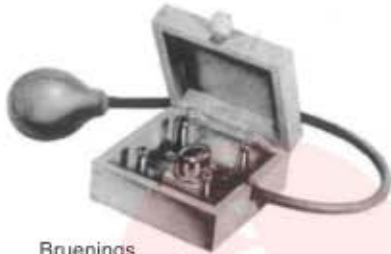

Bruenings
complete
14-073
Bruenings Ear Speculum
Complete Set
with 4 Ear Specula & Otoscope

**MANZIM
SURGICO**



14-074
6.5 mm Ø



14-075
7.5 mm Ø



14-076
8.5 mm Ø



14-077
9.5 mm Ø



**Bruening Magnifier
Otoscope**

Ohrenspekulum, Zerstäuber und Ohrenspritzen

Espéculo de oreja, atomizador y jeringas de oreja

Spéculum auriculaire, atomiseur et seringues auriculaires

Speculum auricolari, atomizzatori e siringhe auricolari



Richnau Holmgren
Ear Speculum
3.5 cm

○
14-078
3 mm Ø

○
14-079
4 mm Ø

○
14-080
5 mm Ø

○
14-081
6 mm Ø



Vacher Nasal Speculum
14-082



Vollolini Nasal Speculum
14-083 Fig. 1
14-084 Fig. 2
14-085 Fig. 3

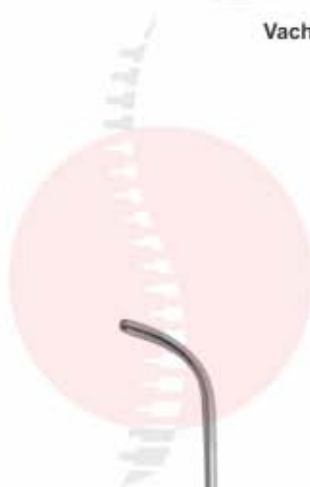

MANZIM
SURGICO



Yankauer
14-086
19cm

- **14-087**
2 mm Ø
- **14-088**
2,5 mm Ø
- **14-089**
3 mm Ø
- **14-090**
4 mm Ø
- **14-091**
5 mm Ø



Hartmann
Eustachian Catheters



Reiner Ear syringe
14-092
50CC Complete
14-093
75CC Complete



Reiner Ear
Syringe
Tip Only
14-096
Tip Only



Reiner Ear
Syringe
Tip Only
14-097
Tip Only



Reiner Ear
Syringe Shield
14-098

14-094
100CC Complete
14-095
150CC Complete
Reiner Ear syringe
With Tip & Shield

Stimmgabeln | Diapasones
Diapasons | Diapasoni



Hartmann Tuning Fork 14-099
C 64

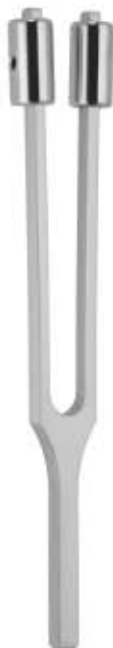

Hartmann Tuning Fork 14-100
c 128



Hartmann Tuning Fork 14-101
c1 256



Hartmann tuning fork with or without plastic base a1 440
14-102
a1 440



Tuning Forks neurolog with hammer 14-103

NOISE DRUM

Lärmtrommel | Aparato
Assourdisseur | Assordatore



Barany Noise Drum 14-104

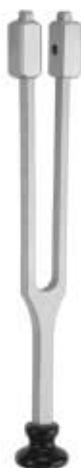

Lucae Tuning Fork 14-105
c 128
Variable up to h (ehn, b)



Rydel-Seiffer Tuning Fork 14-106
C 64 / c 128
With clamps C 64,
Without clamps c 128



French Tuning Fork 14-107
C2 16



French Tuning Fork 14-108
C1 32

TUNING FORKS

Stimmgabeln | Diapasones
Diapasons | Diapasoni

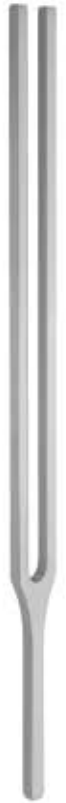

14-109
c 128

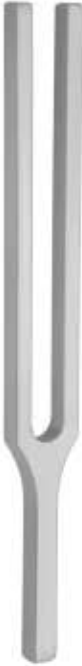

14-110
c1 256



14-111
c2 512



14-112
c3 1024



14-113
c4 2048



14-114
c5 4096



Hartmann Tuning Fork

14-115
Hartmann tuning Forks Set case/5

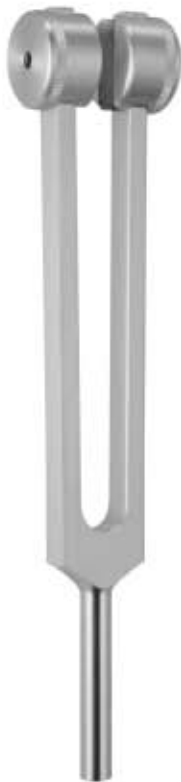

14-116
c 128



14-117
c1 256



14-118
c2 512



14-119
c3 1024



14-120
c4 2048



14-121
TUNING FORKS Set in case of 5

MANZIM
SURGICO

Ohrpolypenschnürer

Polipótomos auriculares

Serre noeuds auriculaires

Serranodi auricolari



Nasal Polypus Snares
14-122

0.3 mm Ø X 100 mm
In bundles of 12 pieces



Krause Nasal Polypous Snares
14-123
25.4 cm



Kraus -Vosse Nasal Polypous Snares
14-124
25.4 cm
With 2 inserts



Kraus -Wilde Nasal Polypous Snares
14-125
24 cm



Krause
14-126
26 cm



EVE Tonsil Snare
28 cm
14-127 without ratchet
14-128 with ratchet



Eves Tonsil Snare



14-129
28 cm



14-130
28 cm



Eves Tonsil Snare



14-131
28 cm



Bruenings Tonsil Snare

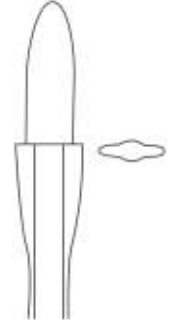

14-132
28 cm



Bruenings
14-133
10 m 33 ft
0.3 mm Ø
14-134
10 m 33 ft
0.4 mm Ø



Bruenings
14-135
40 mm
Package of 100 pieces
14-136
50 mm
Package of 100 pieces

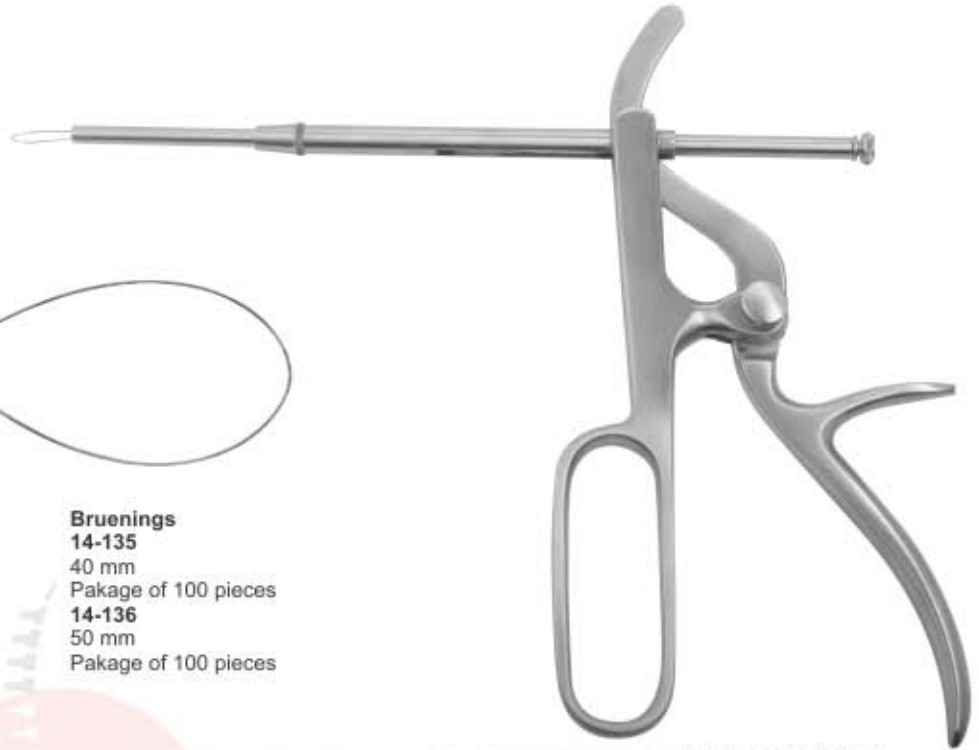

Tyding Tonsil Snare
14-137
With one straight tip

NASAL SPECULUM

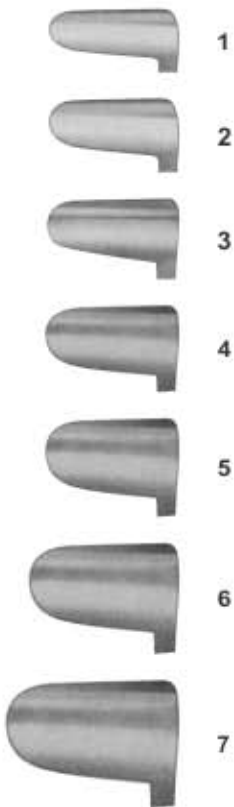

Thudichum (Goldsmith) Nasal Speculum
6.5cm
14-138 Fig. 1
14-139 Fig. 2
14-140 Fig. 3
14-141 Fig. 4
14-142 Fig. 5
14-143 Fig. 6
14-144 Fig. 7



MANZIM
SURGICO



ST-CLAIR THOMSON
14-145 Fig 1
14-146 Fig 2
14-147 Fig 3

Nasenspekulum | Espéculo nasal
Spéculum nasal | Speculum nasale



**Thudichum
(Goldsmith)
Nasal Speculum**



14-148
6.5 cm
21 mm X 9.5 mm



14-149
6.5 cm
21 mm X 10.5 mm



14-150
6.5 cm
21 mm X 11.5 mm



**Hartmann
Nasal Speculum**



14-151
16 cm
Tip Size
27mm



14-152
16 cm
Tip Size
31mm

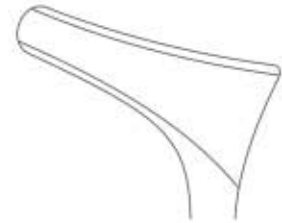

14-153
16 cm
Tip Size
35mm

MANZIM
SURGICO



**Hartmann-Halle
Nasal Speculum**



14-154
15 cm



14-155
15 cm



14-156
15 cm

NASAL SPECULUM

Nasenspekulum | Espéculo nasal
Spéculum nasal | Speculum nasale



14-157
13.5 cm
For babies

Tieck-Halle
Nasal Speculum



14-158
14 cm

Schwarz Nasal Speculum



Vienna Speculum
14-159 13cm
14-160 14.6cm
medium standard patter



14-161
Nose Speculum,
thigh 30mm



14-162
13 cm
X = 35 mm

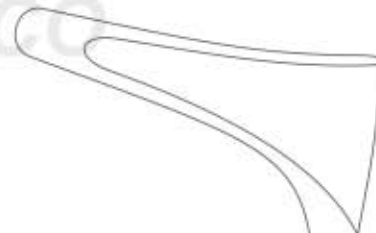

14-163
13 cm
X = 50 mm



Killian Nasal Speculum

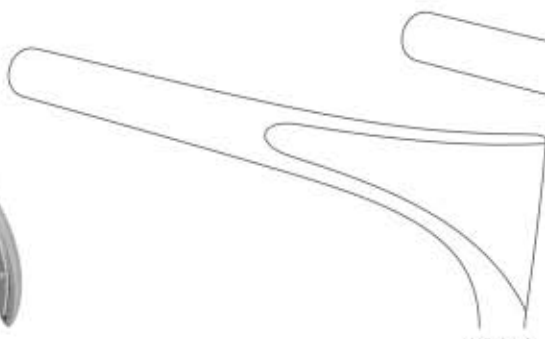

14-164
13 cm
X = 75 mm

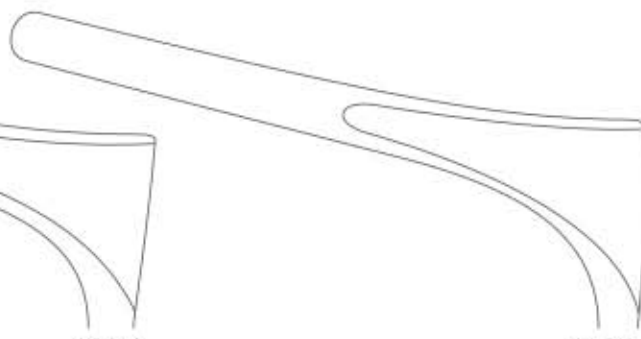

14-165
13 cm
X = 90 mm

Nasenspekulum | Espéculo nasal
 Spéculum nasal | Speculum nasale



Killian Septum Speculum
14-166
 15 cm
 2.51 cm blades
 withset screw



Killian Septum Speculum
14-167
 15 cm
 8.9cm blades
 set screw



Killian Septum Speculum
14-168
 Fiber Optic 15 cm
 length 2.51mm deep



Beckmann
Nasal Speculum



14-169
 15 cm
 25mm

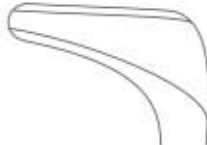

14-170
 15 cm
 28mm

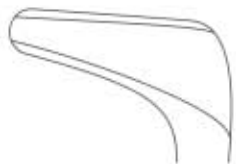

14-171
 15 cm
 32mm



Mod. Wien
Nasal Speculum

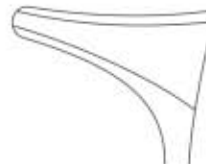

14-172
 14.5 cm
 25cm

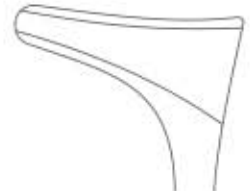

14-173
 14.5 cm
 27cm

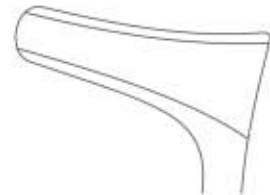

14-174
 14.5 cm
 30cm

NASAL SPECULUM

Nasenspekulum	Espéculo nasal
Spéculum nasal	Speculum nasale



Cottle Nasal Speculum

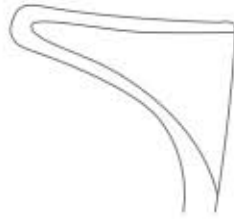

14-175
15 cm
X = 35 mm

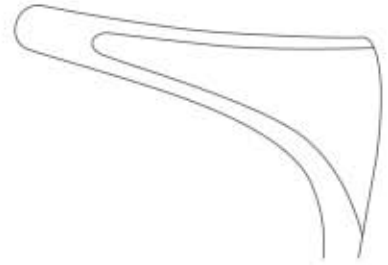

14-176
15 cm
X = 50 mm

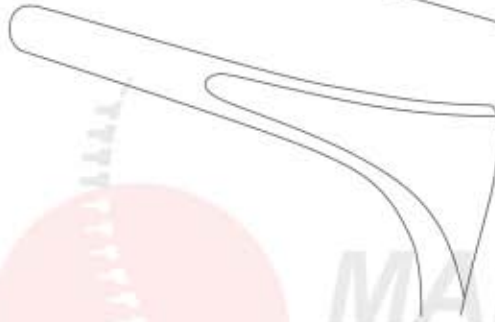

14-177
15 cm
X = 75 mm

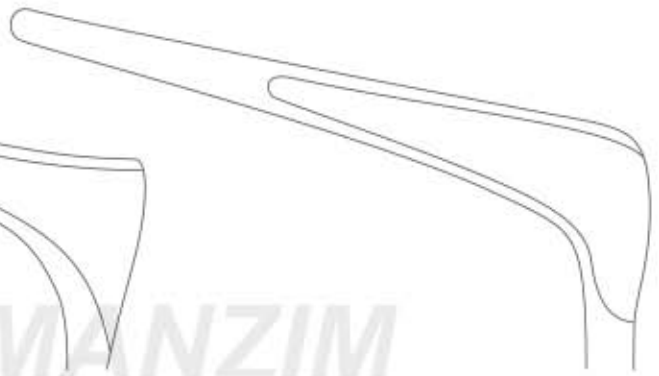

14-178
15 cm
X = 90 mm



Cottle Nasal Speculum



14-179
14 cm
X = 45 mm

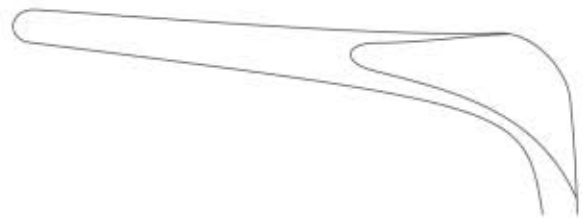

14-180
14 cm
X = 75 mm

Ohrküretten

Curetas auriculares

Curettes auriculaires

Curette auricolari

								
	14-181 16.5 cm 6 1/2" Blunt	14-182 16.5 cm 6 1/2" Blunt	14-183 16.5 cm 6 1/2" Blunt	14-184 16.5 cm 6 1/2" Blunt	14-185 16.5 cm 6 1/2" Blunt	14-186 16.5 cm 6 1/2" Blunt	14-187 16.5 cm 6 1/2" Blunt	14-188 16.5 cm 6 1/2" Blunt
								
	14-189 16.5 cm 6 1/2" Sharp	14-190 16.5 cm 6 1/2" Sharp	14-191 16.5 cm 6 1/2" Sharp	14-192 16.5 cm 6 1/2" Sharp	14-193 16.5 cm 6 1/2" Sharp	14-194 16.5 cm 6 1/2" Sharp	14-195 16.5 cm 6 1/2" Sharp	14-196 16.5 cm 6 1/2" Sharp
								
	14-197 16.5 cm 6 1/2" Curved, Blunt	14-198 16.5 cm 6 1/2" Curved, Blunt	14-199 16.5 cm 6 1/2" Curved, Blunt	14-200 16.5 cm 6 1/2" Curved, Blunt	14-201 16.5 cm 6 1/2" Curved, Blunt	14-202 16.5 cm 6 1/2" Curved, Blunt	14-203 16.5 cm 6 1/2" Curved, Blunt	14-204 16.5 cm 6 1/2" Curved, Blunt
								
Buck, Ear Curette	14-205 16.5 cm 6 1/2" Curved, Sharp	14-206 16.5 cm 6 1/2" Curved, Sharp	14-207 16.5 cm 6 1/2" Curved, Sharp	14-208 16.5 cm 6 1/2" Curved, Sharp	14-209 16.5 cm 6 1/2" Curved, Sharp	14-210 16.5 cm 6 1/2" Curved, Sharp	14-211 16.5 cm 6 1/2" Curved, Sharp	14-212 16.5 cm 6 1/2" Curved, Sharp

Pictures show the outer diameter

Ohrküretten und scharfe Löffel

Curettes auriculaires et cuillères tranchantes

Curettes auriculaires et cuillères tranchantes

Curette auricolari e cucchiari taglienti

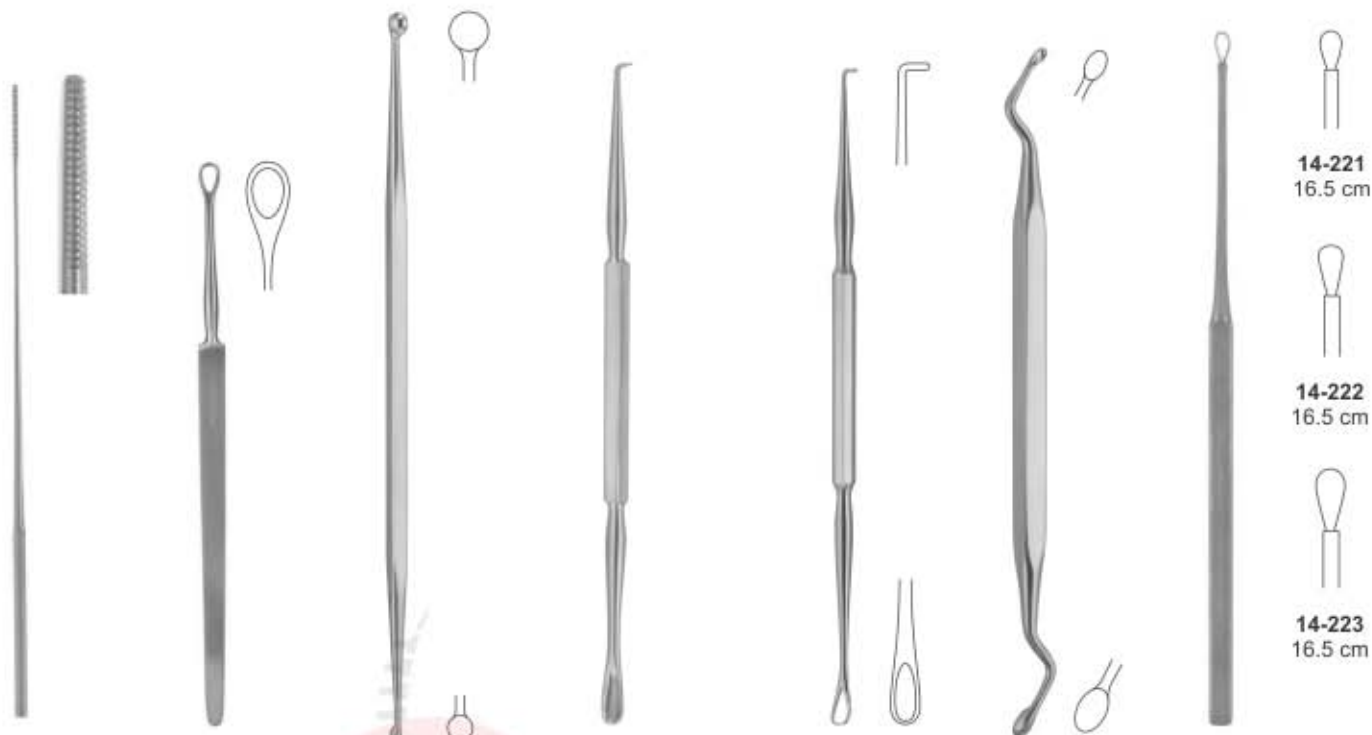

Farrell Applicator
14-213
16.5 cm 6 1/2"
cross-serrated tip

Langenbeck Ear Curette
14-214
13 cm
Blunt

Jansen Ear Curette
14-215 15 cm
14-216 16 cm
14-217 17 cm
Sharp

Gross Ear Spoon
14-218 12 cm
Sharp, Not fenestrated

Gross Ear Curette
14-219 12 cm
Blunt, fenestrated

Gansen Ear Curette
14-220 16 cm
Sharp

Billeau Ear Loop

14-221
16.5 cm

14-222
16.5 cm

14-223
16.5 cm

EAR LOOPS - HOOKS

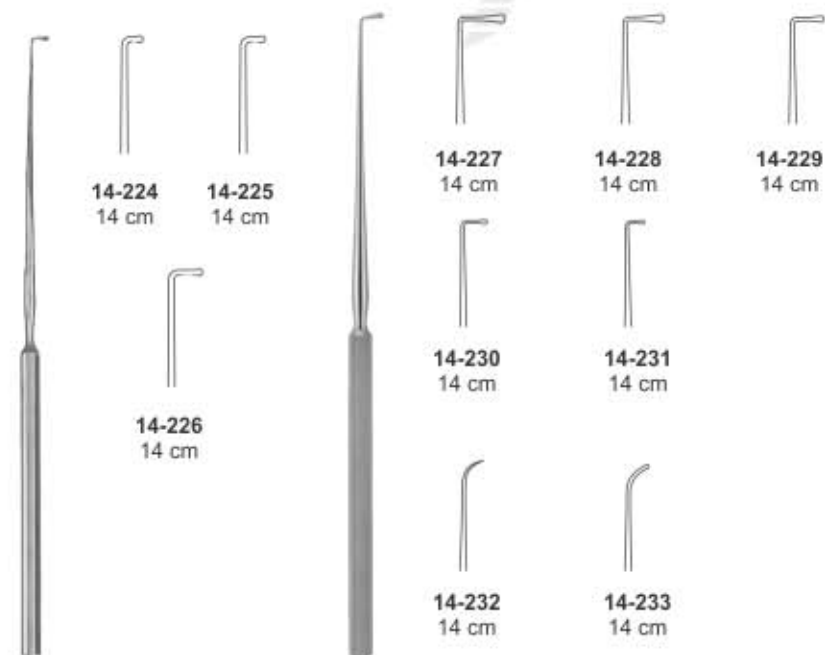

Lucae Hooklet

Wagener Hooklet Buttoned

14-224
14 cm

14-225
14 cm

14-227
14 cm

14-228
14 cm

14-229
14 cm

14-226
14 cm

14-230
14 cm

14-231
14 cm

14-232
14 cm

14-233
14 cm

TONSIL KNIVES



Freer Tonsil Knife
14-234
21 cm 8 1/4"

Freer Tonsil Knife
14-235
21 cm 8 1/4"

Tonsil Knife
14-236
20 cm 8"
Sharp

Tonsil Knife
14-237
20 cm 8"
Sickle knife

Nasenmesser | Cuchillos nasales
 Bistouris pour nez | Bisturi per naso



**Bruenings
Tonsil Knife
14-238**
23 cm 9"



**Abraham
Tonsil Knife
14-239**
22 cm 8 3/4"



**Fischer Tonsil
Knife and Dissector
14-240**
21.6 cm 8 1/2"
semi-sharp tip, with teeth



**Fomon
Nasal Knife
14-241**
16.5 cm



**Joseph
Nasal Knife
14-242**

Fig.1
16.5 cm
S/S Str.



Fig.1
16.5 cm
S/S Cvd.



Fig.2
16.5 cm
S/S Str.



Fig.2
16.5 cm
S/S Cvd.



**Joseph
Nasal Knife
14-246**
14 cm

MANZIM
SURGICO



**Cottle
Nasal Knife
14-247**
15 cm



**Joseph
Nasal Knife
14-248**
17.5 cm



**Converse
Nasal Knife
14-249**
16 cm



**Freer
Nasal Knife
14-250**
15 cm



**Freer
Nasal Knife
14-251**
15 cm



**Freer
Nasal Knife
14-252**
15 cm



**Freer
Nasal Knife
14-253**
19 cm



**Freer
Nasal Knife
14-254**
19 cm



**Bruenings
Septatome
14-255**
16.5 cm
14-256
Bruenings
Spare blade

ANTRUM CURETTES

Antrumküretten | Curetas para el antrum
Curettes d'antrum | Curette per antrum



**Coakley
Antrum Curette**
14-257
21 cm

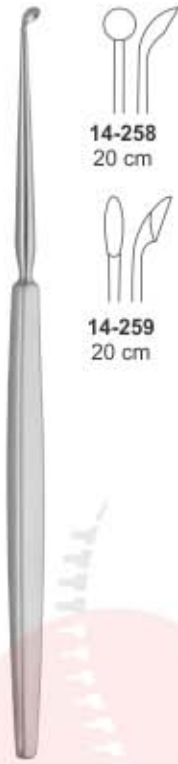

14-258
20 cm

14-259
20 cm

Antrum Curette



Antrum Curette
14-260
20 cm
7 mm X 11 mm



**Pratt Antrum
Curette**
14-261
21 cm



**Faulkner
Antrum Curette**
14-262
21 cm



**Coakley
Antrum Curette**



14-263
17 cm



14-264
17 cm



14-265
17 cm



14-266
17 cm



14-267
17 cm



14-268
17 cm

Antrum Curette
14-269
17 cm
Complete set



**Hypophyseal
Curette** 19cm



**Hypophyseal
Curette** 19cm

Septum elevatorien - Raspatorien

Elevadores - legras para el tabique nasal

Elevateurs - rugines pour la cloison nasale

Elevatori - periostotomi per setto



Lempert Septum Elevators Raspatory 14-272
20.5 cm 8"
X = 6 mm



Lempert Septum Elevators Raspatory 14-273
18 cm 7"
X = 6 mm



Cottle Septum Elevators Raspatory 14-274
19 cm 7 1/2"
X = 8 mm
Sharp



Joseph Septum Elevators Raspatory 14-275
16 cm 6 1/4"
X = 5 mm
Periosteal elevators



Joseph-Masing Septum Elevators Raspatory 14-276
21.5 cm 8 1/2"
Sharp



Pennington Septum Elevators Raspatory 14-277
21.5 cm 8 1/2"
Blunt



Freer Septum Elevators Raspatory 14-278
19 cm 7 1/2"
Blunt



Freer Septum Elevators Raspatory 14-279
18 cm 7"
Sharp/Blunt



Freer Septum Elevators Raspatory 14-280
20.5 cm 8"
Sharp/Blunt



Cottle Septum Elevators Raspatory 14-281
23.5 cm 9 1/4"
X = 5 mm
Sharp

Periostelevatorien, Septumelevatorien

Legras para periostio, Elevadores para el tabique nasal

Elevateurs pour la périoste, Elevateurs pour la cloison nasale

Elevatori per il periosto, Elevatori per setto



Masing Periosteal Septum Elevators
14-282 20 cm 8"



Ballenger-Hajek Periosteal Septum Elevators
14-283 19 cm 7 1/4"
14-284 22 cm 8 3/4"



Cottle Periosteal Septum Elevators
14-285
22 cm 8 3/4"



Cottle Periosteal Septum Elevators
14-286
21 cm 8 1/4"

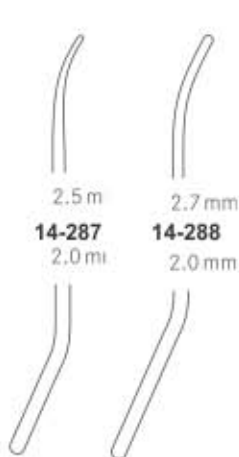

2.5 m 2.7 mm
14-287 2.0 mm
14-288 2.0 mm



Boies
14-289
19 cm 7 1/2"
Nasal fracture elevator,
Blunt



Goldman
14-290
17 cm 6 3/4"
Sseptum displacer



Henke Tonsil Dissector
14-291
23 cm



Henke Tonsil Dissector
14-292
23 cm



Hurd Tonsil Dissector
14-293
22 cm

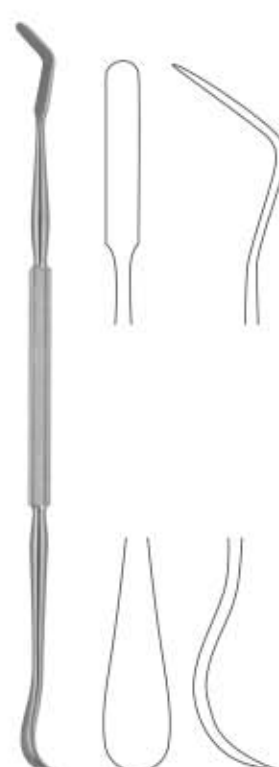

Carpenter Enucleator
14-294
25 cm

Nasensägen / Feile
Scies nasales / Lime

Sierras nasales / archivo
Seghe / file nasali



**Luniatschek
Tonsil
Tampon
Plugger
14-295
19 cm**



**Lewis
Tonsil
Screw
14-296
19.5 cm**



**Joseph
Nasal
Saw
14-297
19 cm 7 1/2"**



**Joseph
Nasal
Saw
14-298
19 cm 7 1/2"**



**Joseph
Nasal
Saw
14-299
19 cm 7 1/2"**



**Maltz Rasp
14-300
21 cm 8-1/4"
improved double end
pattern, forward and
backward cutting**



**Joseph
Rasp
14-301
15.9 cm
fine cross
serrations**



**Joseph Nasal Saw
14-302
17 cm 6 3/4"**

**Joseph Nasal Saw
14-303
17 cm 6 3/4"**

RASPS WITH TUNGSTEN CARBIDE



**Fomon Rasp
with Tungsten
Carbide TC
20cm 8"**



Teeth 12



Teeth 14

14-304



Teeth 16



Teeth 20

14-305



Teeth 24



Teeth 30

14-306



Teeth 36



Teeth 44

14-307



Teeth 52



Teeth 62

14-308

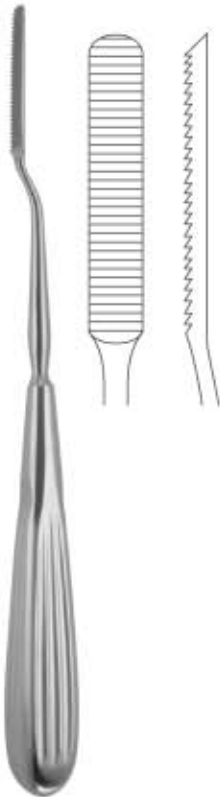

Cottle Nasal Saw
14-309
21 cm 8 1/4"

Maltz Nasal Saw

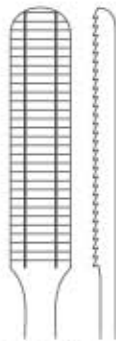

14-310
17 cm 6 3/4"
34 mm x 7 mm
Pushing cut



14-311
17 cm 6 3/4"
34 mm x 7 mm
Drawing cut



Aufricht Nasal Saw
Glabella Rasp,
backward cutting



14-312
21 cm 8 1/4"
Pushing cut



14-313
21 cm 8 1/4"
Drawing cut

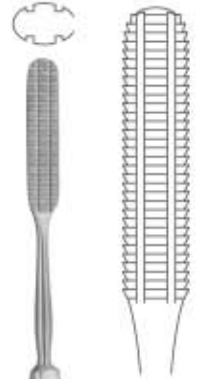

14-314
17.5 cm 7"
40 mm X 9 mm

Maltz Nasal Saw



Wiener Nasal Saw

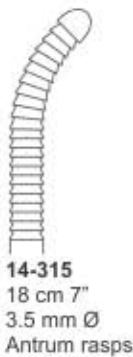

14-315
18 cm 7"
3.5 mm Ø
Antrum rasps



14-316
18 cm 7"
3.5 mm Ø
Antrum rasps



Gallaher Nasal Saw



14-317
16 cm 6 1/4"



14-318
16 cm 6 1/4"



14-319
16 cm 6 1/4"



Fomon Nasal Saw
14-320
21 cm 8 1/4"

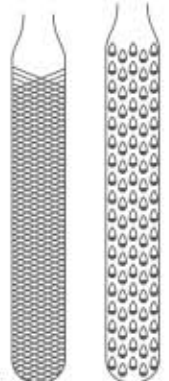
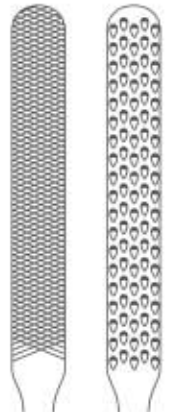

adenoid currettes

Cuchillos para vegetaciones adenoides

Couteaux a vegetations adenoides

Adenotomi



14-321
21 cm 8 1/4"



14-322
21 cm 8 1/4"



14-323
21 cm 8 1/4"



14-324
21 cm 8 1/4"



14-325
22 cm 8 3/4"



14-326
22 cm 8 3/4"



14-327
22 cm 8 3/4"



14-328
22 cm 8 3/4"

**St. Clair-Thomson
Adenoid Curette**

**Barnhill
Adenoid Curette**



14-329
22 cm 8 3/4"
Straight



14-330
22 cm 8 3/4"
Straight



14-331
22 cm 8 3/4"
Straight



14-332
22 cm 8 3/4"
Straight



14-333
22 cm 8 3/4"
Straight



14-334
22 cm 8 3/4"
Straight



14-335
22 cm 8 3/4"
Curved



14-336
22 cm 8 3/4"
Curved



14-337
22 cm 8 3/4"
Curved



14-338
22 cm 8 3/4"
Curved



14-339
22 cm 8 3/4"
Curved



14-340
22 cm 8 3/4"
Curved

**Beckmann
Adenoid Curette**

**Beckman
Adenoid Curette**

adenoid currettes

Couteaux a vegetations adenoides

Cuchillos para vegetaciones adenoides

Adenotomi



La Force



La Force
adenotome
unperforated
Fig 1
14-341
21.6 cm 8 1/2"
25 x 16.0mm
Infant



La Force
adenotome
perforated
Fig 1
14-342
21.6 cm 8 1/2"
25 x 16.0mm
Infant

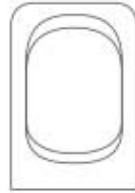

La Force
adenotome
unperforated
Fig 2
14-343
24.1 cm 9 1/2"
26 x 19.3mm
Medium

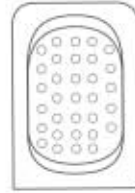

La Force
adenotome
perforated
Fig 2
14-344
24.1 cm 9 1/2"
26 x 19.3mm
Medium



La Force
adenotome
unperforated
Fig 3
14-345
25 cm 10"
30 x 22.2mm
Large

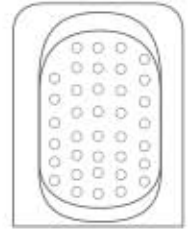

La Force
adenotome
perforated
Fig 3
14-346
25 cm 10"
30 x 22.2mm
Large



Ballenger Knife

14-347
20 cm 8"
X = 3 mm
Straight
14-348
20 cm 8"
Straight
X = 4 mm
14-349
20 cm 8"
Straight
X = 5 mm



Ballenger Knife

14-350
20 cm 8"
X = 3 mm
Bayonet
14-351
20 cm 8"
Bayonet
X = 4 mm
14-352
20 cm 8"
X = 5 mm
Bayonet



Wieder Tongue Depressor
14-353 large blade 36mm
wide serrated

Wieder Tongue
Depressor
14-354 43.5mm
width blade



Blade
Fig 1
14-355



Blade
Fig 2
14-356

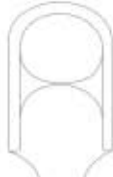

Blade
Fig 3
14-357

Sluder-Ballenger Tonsil
Guillotines &
Punch Forceps
14-358
complete set with 3 blades

Sluder-Ballenger Tonsil
Guillotines & Punch Forceps
Handle
14-359 Handle

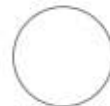

14-360
X = 12 cm
13 mm Ø



14-361
X = 15 cm
13 mm Ø

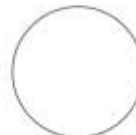

14-362
X = 17 cm
13 mm Ø

Hartmann Tonsil Guillotines
& Punch Forceps



NASAL POLYPUS AND SEPTUM FORCEPS

Nasenpolypenzangen-Septumzangen
Pinces à polypes et la cloison nasale

Pinzas para pólipos y el tabique nasal
Pinze per polipi e setto nasale



Westmacott Nasal Polypus and Septum Forceps
14-363 20 cm 8"



Lubet-Barbon Nasal Polypus and Septum Forceps
14-364 20 cm 8"



Hartmann Nasal Polypus and Septum Forceps
14-365 16 cm 6 1/4"
14-366 20 cm 8"



Tilley Nasal Polypus and Septum Forceps
14-367 14 cm 5 1/2"



Heymann-Knight Nasal Polypus and Septum Forceps
14-368 18 cm 7"



Craig Nasal Polypus and Septum Forceps
14-369 18 cm 7"



Knight Nasal Polypus and Septum Forceps
14-370 18 cm 7"



Littauer Nasal Polypus and Septum Forceps
14-371 18 cm 7"

Ohrpolypenzangen

Pinzas para pólipos auriculares

Pinces pour polypes auriculaires

Pinze per polipi auricolari



Littauer Ear Polypus Forceps
14-372
12 cm 4 3/4"



Hartmann Ear Polypus Forceps
14-373
12 cm 4 3/4"
Delicate jaw



Hartmann Ear Polypus Forceps
14-374
14 cm 5 1/2"
Normal jaw



Quire Ear Polypus Forceps
14-375
10.5 cm 4 1/4"
Foreign body lever



Buck Ear Polypus Forceps
14-376
11.5 cm 4 1/2"
Foreign body forceps



Wilde Nasal Dressing Forceps
14-377
16.5cm 6 1/2"
angular

TONSIL INSTRUMENTS



Troeltsch Dressing Forceps
14-378
11cm, 4 1/2"



Troeltsch Dressing Forceps
14-379
13 cm, 5"



Lucae Dressing Forceps
14-380
14 cm, 5 1/2"



Jansen Dressing Forceps
14-381
16 cm, 6 1/4"

Nasenpolypenzangen, Nasentamponzange

Pinzas para pólipos nasales, Pinza nasale para tamponiamento

Pinces à polypes nasales, Pince à pansement pour le nez

Pinze per polipi nasali, Pinza per tamponamento nasale



14-382
18 cm 7"



14-383
18 cm 7"



14-384
18 cm 7"



Heymann Nasal Dressing Forceps



14-385
19 cm 7 1/2"



14-386
19 cm 7 1/2"



14-387
19 cm 7 1/2"



14-388
19 cm 7 1/2"

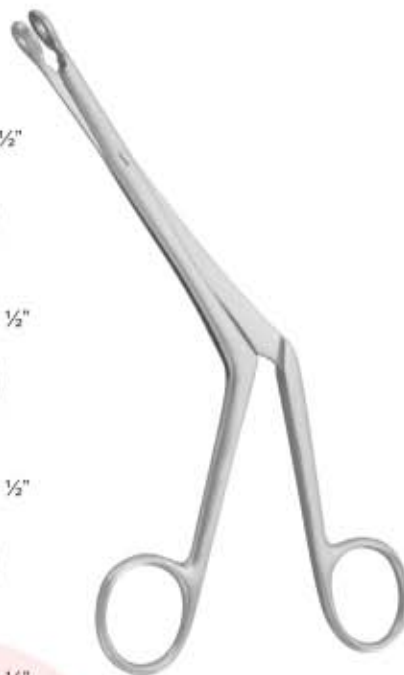

Bruenings Nasal Cutting Forceps



14-389
X = 12 cm 4 3/4"
3.5 mm X 10 mm



14-390
X = 12 cm 4 3/4"
3.5 mm X 10 mm



Takahashi Nasal Cutting Forceps

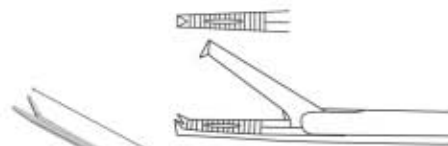

Noyes Nasal Dressing Forceps
14-391
X = 11 cm 3 1/2"
1 X 2



14-392
20 cm 8"
Plaine



14-393
20 cm 8"



14-394
20 cm 8"
Fenestrated



14-395
20 cm 8"



Luc Nasal Cutting Forceps



Weil Nasal Cutting Forceps
14-396
X = 12 cm 4 3/4"

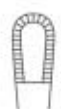

Watson-Williams Nasal Cutting Forceps
14-397
X = 12 cm 4 3/4"



14-398
X = 12 cm 4 3/4"

MANZIM SURGICO











NASAL CUTTING FORCEPS

Scharfe Nasenzangen

Pinzas nasales cortantes

Pinces coupantes pour le nez

Pinze taglianti per naso

	X = 12 cm	 14-399 a - 3.0 mm	 14-400 a - 3.5 mm	 14-401 a - 4.5 mm	 14-402 a - 5.0 mm	 14-403 a - 5.5 mm
	X = 12 cm	14-404 a - 3.0 mm	14-405 a - 3.5 mm	14-406 a - 4.5 mm	14-407 a - 5.0 mm	
	X = 12 cm	14-408 a - 3.0 mm	14-409 a - 3.5 mm	14-410 a - 4.5 mm		
	X = 18 cm	14-411 a - 3.0 mm	14-412 a - 3.5 mm	14-413 a - 4.5 mm	14-414 a - 5.0 mm	14-415 a - 5.5 mm
	X = 18 cm	14-416 a - 3.0 mm	14-417 a - 3.5 mm	14-418 a - 4.5 mm	14-419 a - 5.0 mm	





Weil-Blakesley
Nasal Cutting Forceps

 14-420 X = 12 cm	 14-421 X = 12 cm	 14-422 X = 12 cm	 14-423 X = 12 cm
---	---	---	--



Myles Nasal
Cutting Forceps

 14-424 X = 12 cm 2.0 mm X 10 mm	 14-425 X = 12 cm 2.5 mm X 12 mm	 14-426 X = 12 cm 3 mm X 14 mm
---	---	--



Hartmann Nasal
Cutting Forceps

Keilbeinstanzen

Pinzas para esfenoideas

Pinces pour le sinus sphénoïdal

Pinze sfenoidali taglianti



Citelli Bone Ear Rongeurs
14-427 17 cm 6 3/4"
X = 60 mm



Kerrison Bone Ear Rongeurs
14-428 20 cm 8"
X = 80 mm



Beyer Bone Ear Rongeurs
14-429 14 cm 1 mm
14-430 19 cm 2 mm

MANZIM
SURGICO

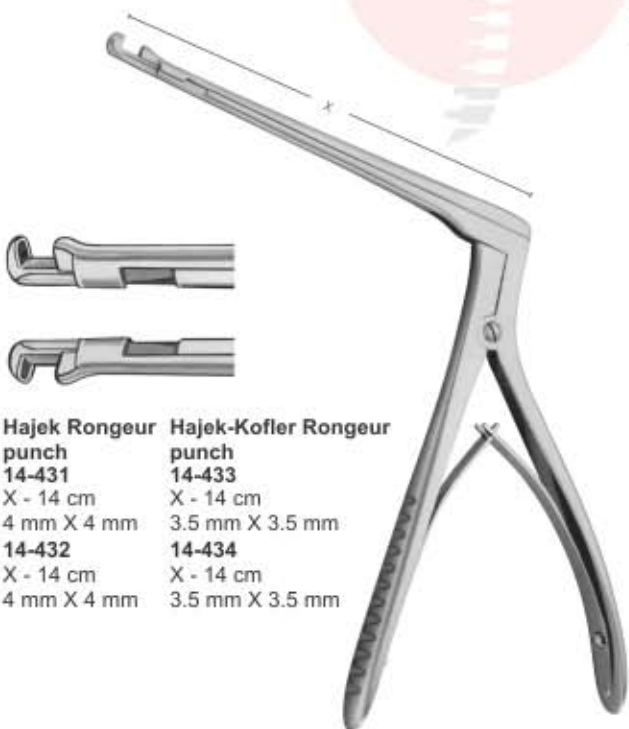

Hajek Rongeur punch
14-431
X - 14 cm
4 mm X 4 mm

Hajek-Kofler Rongeur punch
14-433
X - 14 cm
3.5 mm X 3.5 mm



Hajek-Claus Rongeur punch
14-435 20 cm



Hajek-Kofler Rongeur punch
14-436
X - 18 cm
3.5 mm
Shaft rotates 360°

Septuminstrumente
instruments pour la cloison nasal

Instrumentos para el tabique nasal
Strumenti per il setto nasale



Bruenings-Brunk
14-437
19 cm 7 1/2"
Antrum Retractor
Serrated



Ritter-Halle
14-438 16 cm 6 1/4"
2.5 mm Ø
14-439 16 cm 6 1/4"
3.0 mm Ø
14-440 16 cm 6 1/4"
4.0 mm Ø
Forntal sinus bougies

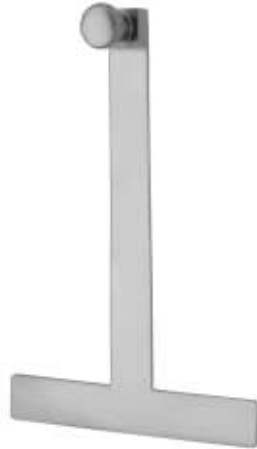

Cottle
14-441
1.2 cm 4 3/4"
Handle



Cottle
14-442
7 mm
Guide support
for osteotomes



Cottle
14-443
65 mm X 30 mm X 30 mm
Cartilage crusher

MANZIM
SURGICO



Cottle-Walsham
Septum Forceps



14-444
23 cm 9"
Straight



14-445
23 cm 9"
Left



14-446
23 cm 9"
Right



Ash Septum
Forceps
14-447
23 cm 9"

SEPTUM FORCEPS

Septumzangen

Pinzas para el tabique nasal

Pinces pour la cloison nasale

Pinze per il setto nasale



**Middleton-Jansen
Septum Forceps**
14-448 19 cm



**Middleton-Jansen
Septum Forceps**
14-449 19 cm

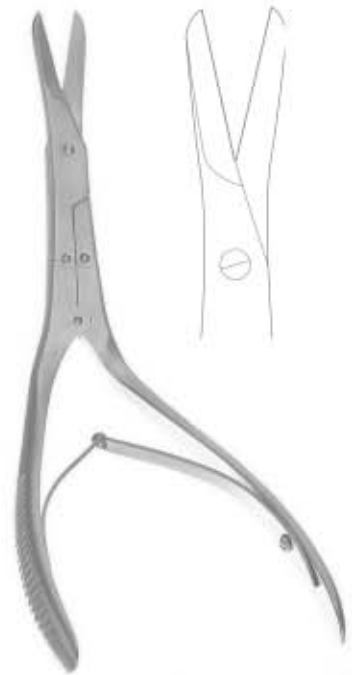

**Caplan Septum
Forceps**
14-450 20 cm
Toothed



**Rubin Septum
Forceps**
14-451
21 cm
Protection cap

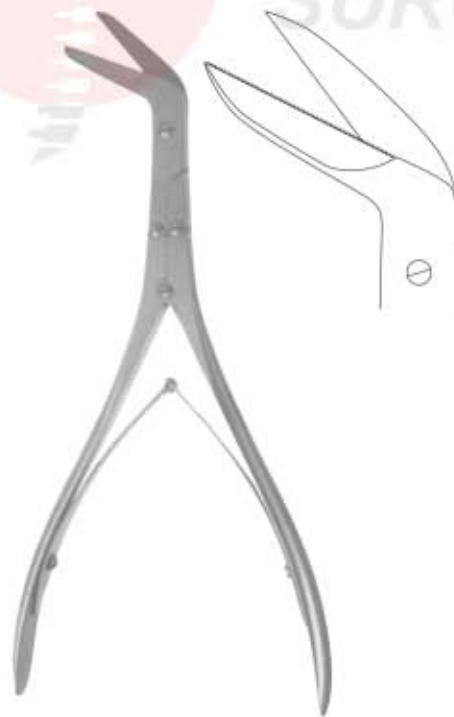

Killian
14-452
20 cm
Laryngotomy scissors



**Reichert Epiglottis
Retractor**
14-453
23 cm



**Aufrecht Retractor
Speculum**
14-454
16.5cm
solid blade





Tobold
14-455
Tongue Depressor
14.5 cm



Hartmann
14-456
15 cm



Cheek Retractor
14-457
14.5 cm



Cawood-Minnesota
14-458
Cheek Retractor
15 cm



MANZIM
SURGICO



Sternberg
14-459
Lip and Cheek Retractor
14 cm



Obwegeser
14-460
Cheek Retractor
12 cm



Vestibulum Retractor
14-461
14 cm



Oringer
Lip and Cheek Retractor
14-462 9.5cm
14-463 10 cm
14-464 10.5cm
14-465 11 cm

SPATULA, RETRACTORS

Spachtel, Retraktoren | Espátula, retractores
 Spatule, écarteurs | Spatola, divaricatori



Obwegeser
14-466
 Channel Retractor
 17 cm



Obwegeser
14-467
 Chin Retractor
 16.5 cm



Retractor
14-468
 18.5 cm



Tongue Spatula
14-469
 16 cm



Martin
14-470
 Tongue Spatula
 18.5 cm



Haberer flexible
 Abdominal and Intestinal
14-471
 spatulas 33cm (40mm)



Bruenings Tongue
Depressors
14-472
 19 cm



Obwegeser
14-473
 Soft Tissue Retractor
 21.5 cm



Obwegeser
14-474
 Nasal Spine Retractor
 22 cm



Obwegeser
14-475
 Ramus Retractor
 22 cm



Doyen
14-476
 Tongue Spatula
 13.5 cm

Mundsperrer | Abrebocas
Ouvre-bouches | Apribocca



**Whitehead
Mouth Gag**
14-477 11 cm 4 1/4"
14-478 13 cm 5"
14-479 15 cm 6"



**Heister
Mouth Gag**
14-484
13 cm 5"



**Mauder
Mouth Gag**
14-485
10 cm 4"
4 mm Ø
Wood

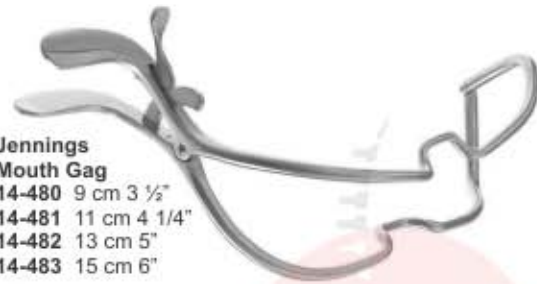

**Jennings
Mouth Gag**
14-480 9 cm 3 1/2"
14-481 11 cm 4 1/4"
14-482 13 cm 5"
14-483 15 cm 6"

MANZIM
SURGICO



Molt Mouth Gag
14-486
11 cm 4 1/4"
For children



Molt Mouth Gag
14-487
14 cm 5 1/2"
For adults



**Denhart
Mouth Gag**
14-488
12 cm 4 3/4"



**Fergusson-Ackland
Mouth Gag**
14-489
14.5 cm 5 3/4"



**Roser-Konig
Mouth Gag**
14-490
16 cm 6 1/4"
14-491
19 cm 7 1/2"

Mundsperrer | Abre bocas
Ouvre-bouches | Apribocca



**Dingmann Cleft Palate
Repair Mouth Gag**
14-492
14.5 cm



14-493
Mouth Gag
Blade
55 mm X 25 mm



14-494
Mouth Gag
Blade
60 mm X 27 mm



14-495
Mouth Gag
Blade
70 mm X 30 mm



Kilner-doughty Mouth Gag
14-496

Complete with frame, 3 tongue depressors and 2 adjustable lateral blades

MANZIM
SURGICO

14-497
Mouth Gag
Blade
28 mm X 65 mm

14-498
Mouth Gag
Blade
32 mm X 75 mm

14-499
Mouth Gag
Blade
37 mm X 80 mm

14-500
Mouth Gag
Blade
40 mm X 90 mm

14-501
Mouth Gag
Blade
45 mm X 100 mm

**Complete Kilner-doughty
Mouth Gag Set With 3 Blades**
14-502



**Kilner-Doughty Mouth
Gag Handle**
14-503



**Negus Mouth
Gag Complete
Set**
14-504



14-505
Mouth Gag
Blade
20X70mm



14-506
Mouth Gag
Blade
30X80mm



14-507
Mouth Gag
Blade
33X95mm



**Negus Mouth
Gag Handle**
14-508

Davis-boyle Mouth
Gag Complete Set
with five blades
14-509



14-510
Mouth Gag
Blade
20 mm X 26 mm



14-511
Mouth Gag
Blade
23 mm X 65 mm



14-512
Mouth Gag
Blade
24 mm X 80 mm



14-513
Mouth Gag
Blade
25 mm X 93 mm



14-514
Mouth Gag
Blade
26 mm X 108 mm



**Davis-Boyle
Mouth Gag
Handle
14-515**



14-517
Mouth Gag Blade
23 mm X 70 mm



14-518
Mouth Gag Blade
25 mm X 86 mm



**McLvor Mouth Gag
Handle
14-520**

**McLvor Mouth Gag
Complete Set
14-516**

14-519
Mouth Gag Blade
26 mm X 100 mm



**Roser-Knig
14-521
Mouth Gag
13.5 cm**

Tonsilleninstrumente
Instruments pour amygdales

Instrumentos para amígdalas
Strumenti per tonsille



Jackson
14-522
22 cm 8 3/4"
Laryngeal forceps



Marschik
14-523
22 cm 8 3/4"
Tonsil seizing forceps



Blohmke
Tonsil
Forceps
14-524
20 cm 8"



Colver Tonsil
Forceps
14-525
19 cm 7 1/2"
Straight
14-526
19 cm 7 1/2"
Curved



White Tonsil
Seizing Forceps
14-527
19.1 cm 7 1/2"
14-528
23 cm 9"

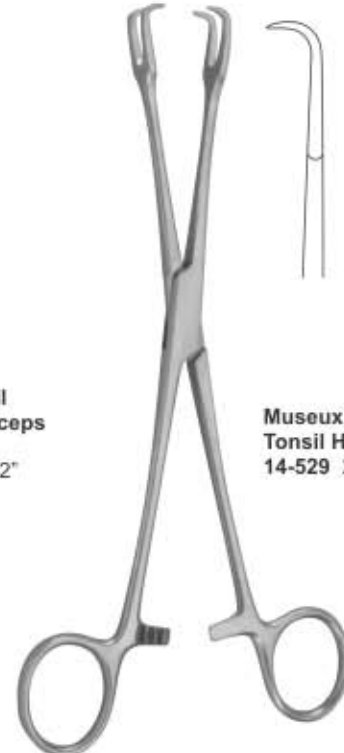

Museux
Tonsil Holding
Forceps
14-529 20 cm 8"

Kehlkopfspiegel
Miroirs laryngiens

Espejos laringeos
Specchi laringei



- 14-530 8 mm Ø
- 14-531 10 mm Ø
- 14-532 12 mm Ø
- 14-533 14 mm Ø
- 14-534 16 mm Ø
- 14-535 18 mm Ø
- 14-536 20 mm Ø
- 14-537 22 mm Ø
- 14-538 24 mm Ø
- 14-539 26 mm Ø
- 14-540 28 mm Ø
- 14-541 30 mm Ø

Laryngeal mirrors



Laryngeal Mirrors
Handle
14-541
10 cm



- 14-542 8 mm Ø
- 14-543 10 mm Ø
- 14-544 12 mm Ø
- 14-545 14 mm Ø
- 14-546 16 mm Ø
- 14-547 18 mm Ø
- 14-548 20 mm Ø
- 14-549 22 mm Ø
- 14-550 24 mm Ø
- 14-551 26 mm Ø
- 14-552 28 mm Ø
- 14-553 30 mm Ø

Laryngeal Mirrors
with Handle



- 14-554 10 mm Ø
- 14-555 12 mm Ø
- 14-556 14 mm Ø
- 14-557 16 mm Ø
- 14-558 18 mm Ø

Michel Moveable
Mirror

GOITRE GRASPING FORCEPS - GOITRE ENUCLEATOR



Mastin Goitre
Grasping Forceps
14-559
17 cm



Lahey Goitre
Grasping Forceps
14-560 15 cm
14-561 20 cm



Kocher Goitre
Enucleator
14-562
16 cm



Kocher Goitre
Enucleator
14-563
16 cm
With Hole

Trachealdilatatoren, Trachealkanulen

Dilatadores para la traqueotomia, Cabykas oara ka traqvea

Dilatateurs pour la tracheotomie, Canules pour la tracheotomie

Dilatatori tracheali, Cabbyke tracheali



Laborde Trachea Dilator 3 Prong
14-564 14 cm

Trousseau Trachea Dilator 2 Prong
14-565 14 cm

Bowlby Trousseau Tracheal Dilator Bowlby Paediatric
14-566 15.5 cm



Uckermann Trachea Tubes
14-567
13 cm
10 mm Ø



Luer-Standard Trachea Tubes
German silver

- 14-568 4 mm Ø
- 14-569 5 mm Ø
- 14-570 6 mm Ø
- 14-571 7 mm Ø
- 14-572 8 mm Ø
- 14-573 9 mm Ø
- 14-574 10 mm Ø
- 14-575 11 mm Ø
- 14-576 12 mm Ø
- 14-577 13 mm Ø



Chevalier-Jackson Trachea Tubes
German silver

- 14-578 4 mm Ø
- 14-579 5 mm Ø
- 14-580 6 mm Ø
- 14-581 7 mm Ø
- 14-582 8 mm Ø
- 14-583 9 mm Ø
- 14-584 10 mm Ø
- 14-585 11 mm Ø
- 14-586 12 mm Ø
- 14-587 13 mm Ø

Wundhäkchen, Mikrohäkchen
Ganchito, Micro Ganchitos

Crochet, Micro crochets
Divaricatore, Micro Divaricatori



Bruenings Retractor

- 14-588** 20 cm
- 14-589** 30 cm
- 14-590** 40 cm
- 14-591** 50 cm
- 14-592** 60 cm



Bruenings Retractor
14-593
20 cm



Huber Retractor
14-594

TRACHEOTOMY SET

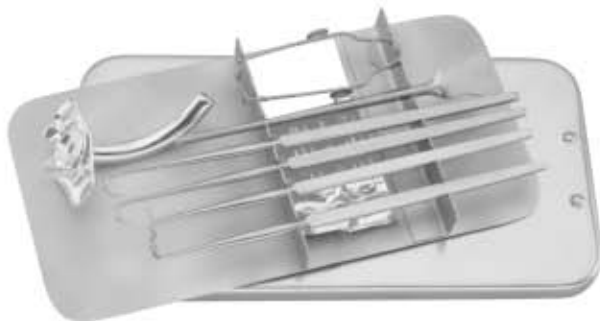
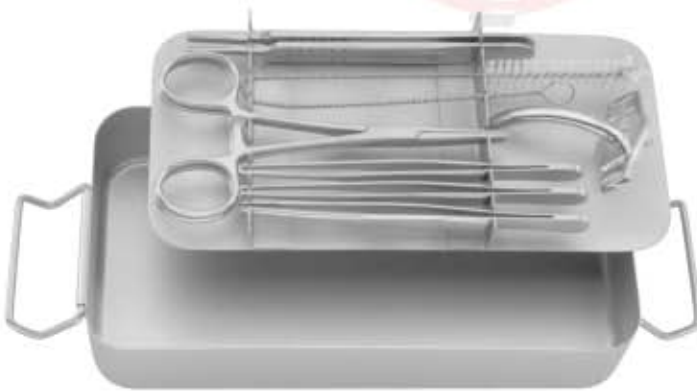

14-595

Tracheotomy Broncho-Oesophagoscopy Forceps set, In metal case, Consisting of:

- 200mm x 105mm x 30mm
- 1 Handle, 1 Blade
- 1 Handle, 1 Blade
- 1 Dressing Forceps, 130mm
- 2 Tissue Forceps, 1 x 2 teeth, 130mm
- 2 Rochester Pean Hemostatic forceps, 130mm
- 1 Grooved director, 130mm
- 1 Bose trachea dilator
- 2 iterson trachea retractors, blunt
- 1 Bose trachea retractor, 160mm, sharp, right
- 1 Bose trachea retractor, 160mm, left, right
- 1 Luer trachea tube, standard, 7mm, german silver
- 1 Luer trachea tube, standard, 8mm, german silver
- 1 Cleaning brush

Ohrzängchen | Pinzas auriculares
Pincès auriculaires | Pinze auricolari



**Hartman
Ear Forceps
14-596**

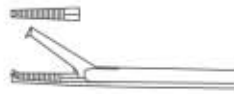

**Hartmann
Ear Forceps
14-597
X = 8.5 cm
14-598
X = 14 cm**



**Hartmann
Ear Forceps
14-599
X = 8.5 cm
14-600
X = 14 cm
14-601
X = 16 cm**



**Hartmann
Ear Forceps
14-602 2 mm Ø
X = 8.5 cm
14-603 2.5 mm Ø
X = 8.5 cm
14-604 3 mm Ø
X = 8.5 cm**



**Hartmann
Ear Forceps
14-606**



**Hartmann-Wullstein
Ear Forceps
14-606
X = 8.5 cm**



**Hartmann-Wullstein
Ear Forceps
14-607
1 mm Ø
X = 8.5 cm**



**Hartmann-Weingartner
Ear Forceps
14-608
X = 8.5 cm**



**Duckbill
Ear Forceps
14-609**



**Weingärtner
Ear Forceps
14-610**



**Strümpel
Ear Forceps
14-611**



**Hartmann-hoffmann
Ear Forceps
14-612**

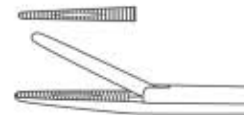

**Hartmann-Noyes
Ear Forceps
14-613
X = 9 cm**



**Struempel
Ear Forceps
14-614 0°
X = 8.5 cm**



**Struempel
Ear Forceps
14-615 45°
X = 8.5 cm**



**Struempel
Ear Forceps
14-616 90°
X = 8.5 cm**

Mikro Instrumente für Laryngo broncho Oesophagoskopie
Micro instruments pour laryngo-bronco-oesophagoscopie

micro instrumental para laringo bronco esofagoscopia
Micro strumenti per laringo bronco esofagoscopia



Micro Alligator Scissors



14-617 Straight
14-618 Straight, Horizontal
14-619 Angled up
14-620 Angled up, Horizontal
14-621 Curved right
14-622 Curved left

Alligator Forceps



14-623 Straight, Serrated
14-624 Straight, Horizontal
14-625 Angled up, Horizontal
14-626 Curved right
14-627 Curved left

Micro Alligator Cup shaped forceps
○ 2.5 mm



14-628 Straight
14-629 Angled up
14-630 Angled up, Horizontal
14-631 Curved right
14-632 Curved left

Micro Alligator Cup shaped forceps
○ 3 X 5 mm



14-633 Oval

MANZIM
SURGICO

BRONCHO OESOPHAGOSCOPY FORCEPS



14-634
X = 30 cm
14-635
X = 40 cm
14-636
X = 50 cm
14-637
X = 60 cm

14-638
X = 30 cm
14-639
X = 40 cm
14-640
X = 50 cm
14-641
X = 60 cm

14-642
X = 30 cm
14-643
X = 40 cm
14-644
X = 50 cm
14-645
X = 60 cm

14-646
X = 30 cm
14-647
X = 40 cm
14-648
X = 50 cm
14-649
X = 60 cm

Chevalier-Jackson
Broncho
Oesophagoscopy
Forceps



14-650
X = 30 cm
14-651
X = 40 cm
14-652
X = 50 cm
14-653
X = 60 cm



14-654
X = 30 cm
14-655
X = 40 cm
14-656
X = 50 cm
14-657
X = 60 cm



14-658
X = 30 cm
14-659
X = 40 cm
14-660
X = 50 cm
14-661
X = 60 cm

Mikro Instrumente für laryngo broncho Oesophagoskopie
Micro instruments pour laryngo-bronco-oesophagoscopie

micro instrumental para laringo bronco esofagoscopia
Micro strumenti per laringo bronco esofagoscopia

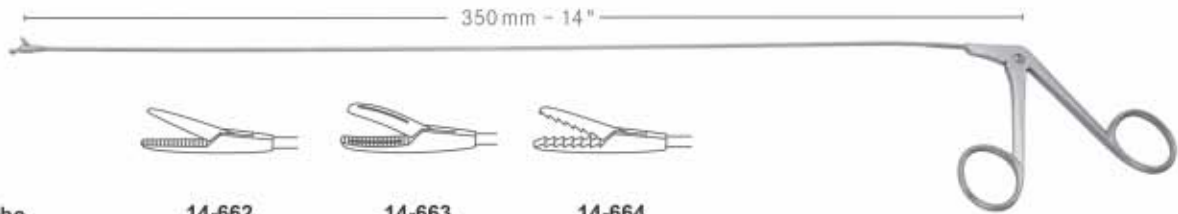

Grasping Broncho Oesophagoscopy Forceps



- 14-662**
Straight,
Serrated
- 14-663**
Straight,
Fenestrated
- 14-664**
Straight

Cup shaped Broncho Oesophagoscopy Forceps
 ○ 3 mm



- 14-665**
Straight
- 14-666**
Angled up
- 14-667**
Angled up,
Horizontal
- 14-668**
Curved right
- 14-669**
Curved left

Cup shaped Broncho Oesophagoscopy Forceps



- 14-670**
Straight
- 14-671**
Angled up
- Universal Broncho Oesophagoscopy Forceps**
- 14-672**
Curved left

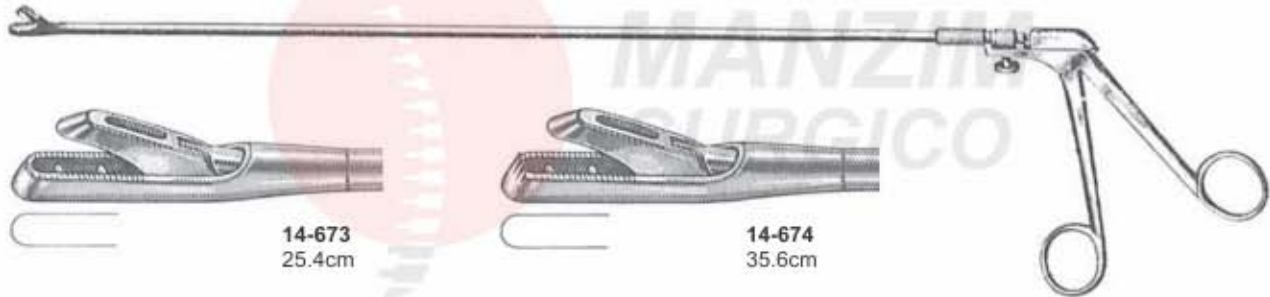

14-673
25.4cm

14-674
35.6cm

Yeoman Biopsy Forceps
 with Rotating Shafts, straight
 4 X 8 mm bite, with basket



Punch Broncho Oesophagoscopy Forceps

- | | | | |
|----------------------------|----------------------------|----------------------------|----------------------------|
| 14-675
X = 40 cm | 14-678
X = 40 cm | 14-681
X = 40 cm | 14-684
X = 40 cm |
| 14-676
X = 50 cm | 14-679
X = 50 cm | 14-682
X = 50 cm | 14-685
X = 50 cm |
| 14-677
X = 60 cm | 14-680
X = 60 cm | 14-683
X = 60 cm | 14-686
X = 60 cm |
| Straight | Straight,
Serrated | Straight,
Fenestrated | Straight |

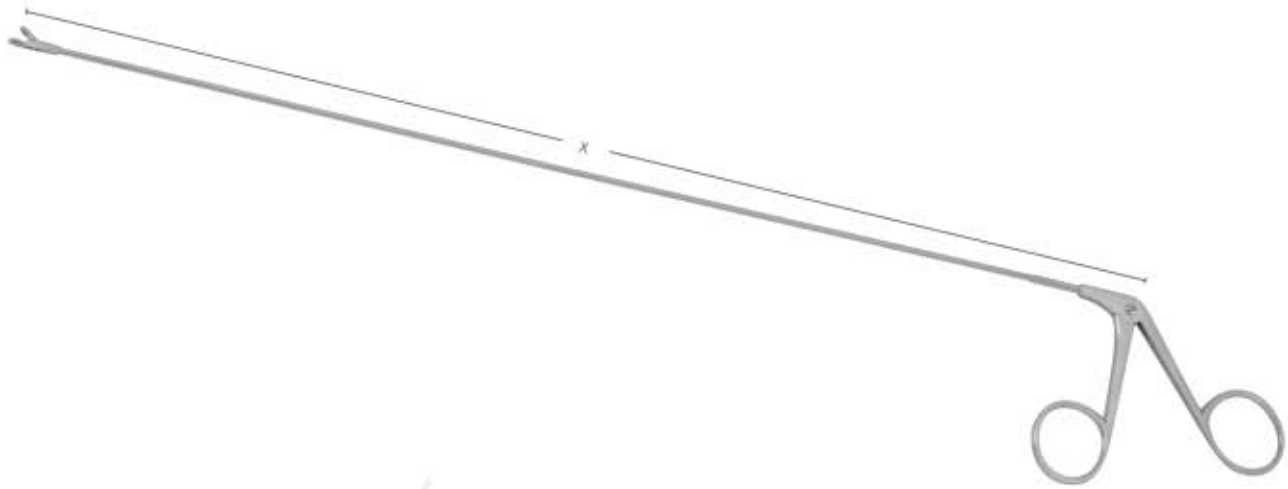

Cup shaped Broncho Oesophagoscopy Forceps



14-687
X = 40 cm
4 mm
14-688
X = 50 cm
4 mm
14-689
X = 60 cm
4 mm
Straight

14-690
X = 40 cm
4 mm
14-691
X = 50 cm
4 mm
14-692
X = 60 cm
4 mm
Angled up

14-693
X = 40 cm
4 mm
14-694
X = 50 cm
4 mm
14-695
X = 60 cm
4 mm
Angled up,
horizontal

14-696
X = 40 cm
4 mm
14-697
X = 50 cm
4 mm
14-698
X = 60 cm
4 mm
Curved right

Cup shaped Broncho Oesophagoscopy Forceps



14-699
X = 40 cm
4 mm
14-700
X = 50 cm
4 mm
14-701
X = 60 cm
4 mm
Curved left

14-702
X = 40 cm
3 mm X 4 mm
14-703
X = 50 cm
3 mm X 4 mm
14-704
X = 60 cm
3 mm X 4 mm
Straight

14-705
X = 40 cm
4 mm X 6 mm
14-706
X = 50 cm
4 mm X 6 mm
14-707
X = 60 cm
4 mm X 6 mm
Straight

14-708
X = 40 cm
4 mm X 8 mm
14-709
X = 50 cm
4 mm X 8 mm
14-710
X = 60 cm
4 mm X 8 mm
Straight



14-711
X = 40 cm
14-712
X = 50 cm
14-713
X = 60 cm
Straight

LARYNGEAL POLYPUD FORCEPS

Kehlkopfpolypenzangen
Pincas a polipos laryngeos

Pinzas para polipos laringeos
Pinze per polipi laringei

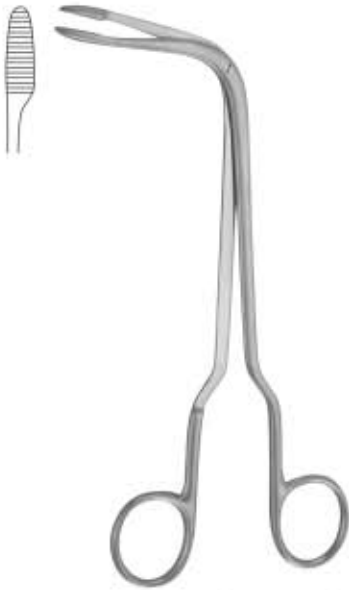

Fraenkel Laryngeal Polypud Forceps
14-714 18 cm



Fraenkel Laryngeal Polypud Forceps
14-715
X = 17 cm
Both jaws articulated

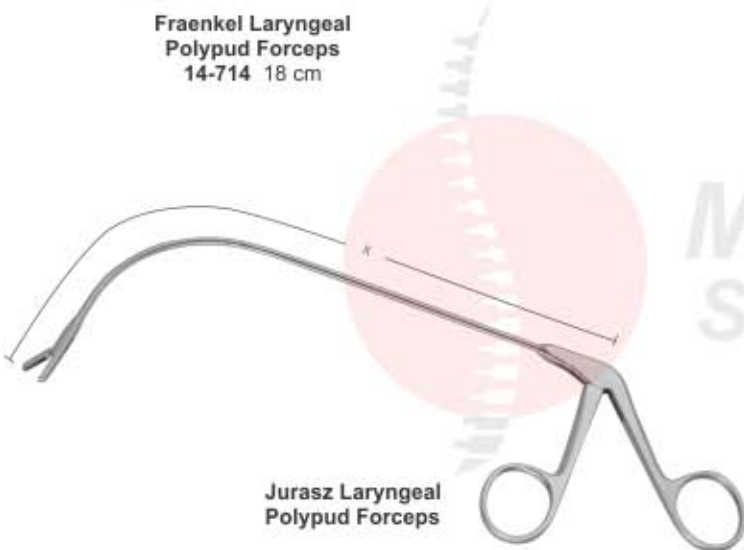

Jurasz Laryngeal Polypud Forceps



Jurasz Laryngeal Polypud Forceps



14-716
23 cm
Right



14-717
23 cm
Left



14-720
23 cm
Right



14-721
23 cm
Left



14-718
23 cm
Downwards



14-719
23 cm
Upwards



14-722
23 cm
Downwards



14-723
23 cm
Upwards

INTESTINAL AND RECTAL INSTRUMENTS



INTESTINAL & TISSUE GRASPING FORCEPS

Darm-und Gewebefasszangen | Pincas Pour Saisir Intestins et Tissus
 Pinzas Para Intestinos y Tejidos | Pinze Per Afferrare Intestino e Tessuti

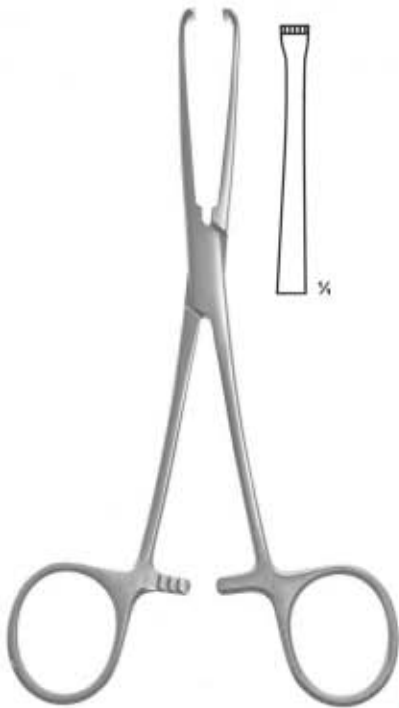

Allis Tissue Forceps
 15-001 15 cm
 3 x 4 teeth

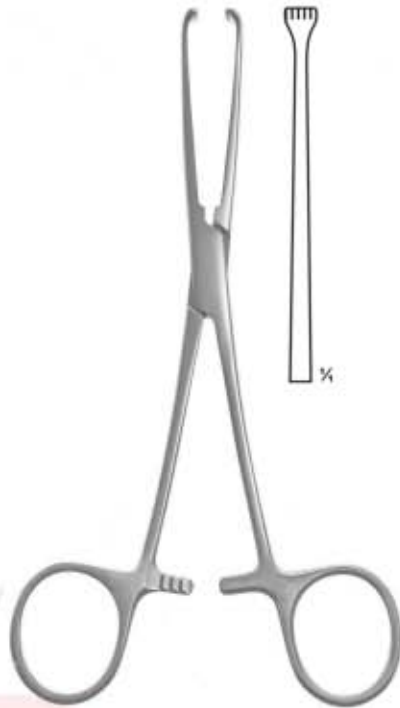

Allis Tissue Forceps
 15-002 15.5 cm
 4 x 5 teeth

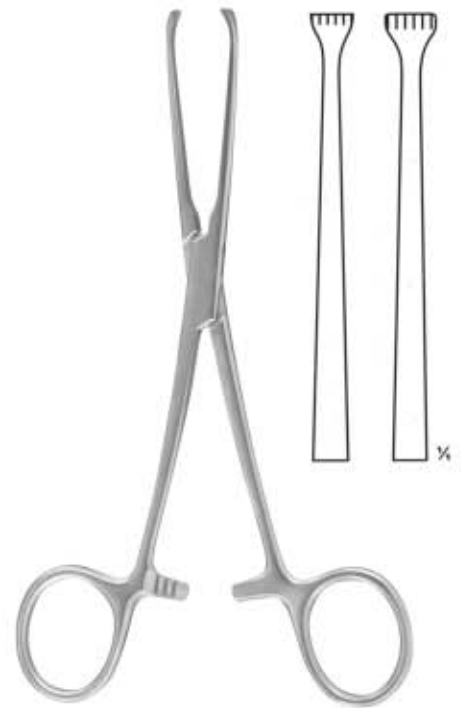

Allis Tissue Forceps
 15-003 16 cm
 15-004 19 cm
 15-005 22 cm
 15-006 25.5 cm
 5 x 6 teeth



Baby Allis Tissue Forceps
 15-007 12 cm 4 X 5 teeth
 15-008 14 cm 4 X 5 teeth
 delicate jaws 4 mm wide

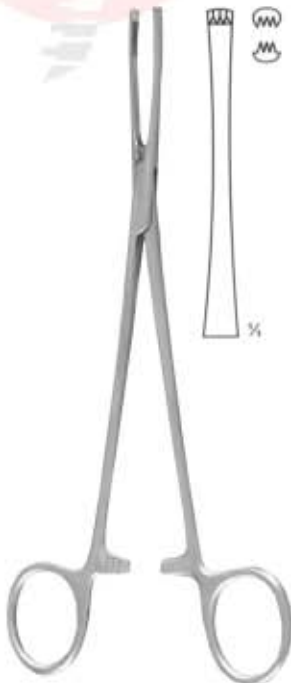

Judd-Allis Tissue Forceps
 15-009 19.5 cm
 3 x 4 teeth



Williams Grasp Forceps
 15-010 16 cm



Boys-Allis Tissue Forceps
 15-011 15.5 cm
 5 x 6 teeth, sharp

MANZIM
 SURGICO



Allis Tissue Grasping Forceps



Allis-Adair
15-017
Intestinal and Tissue Grasping Forceps
16 cm



Thoms-Allis
15-018
Intestinal and Tissue Grasping Forceps
20.5 cm



Chaput Tissue Forceps
15-019 12.5 cm
2 x 3 teeth, sharp

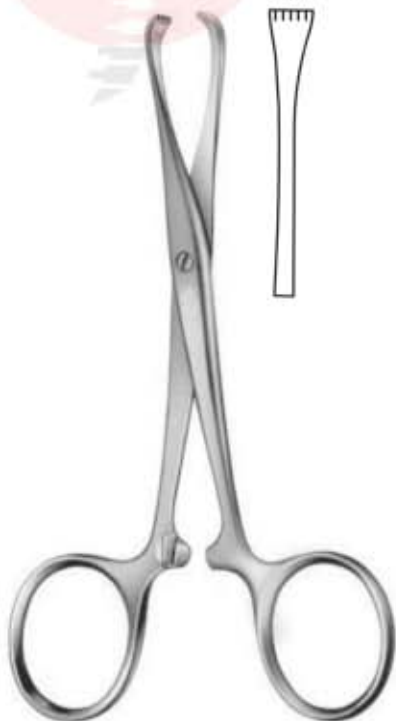

Tuffier Tissue Forceps
15-020 12.5 cm
5 x 6 teeth, sharp

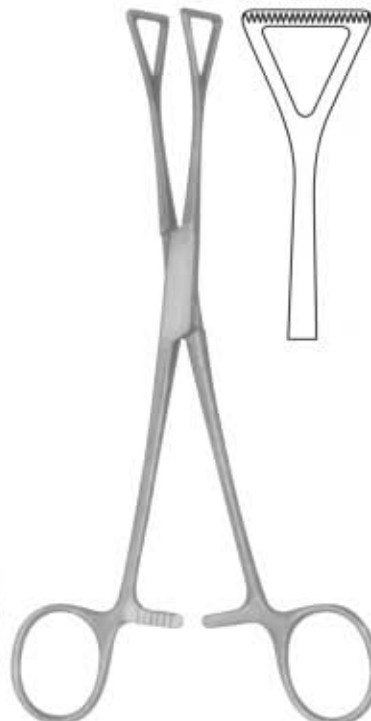

Duval-Collin Grasp Forceps
15-021 18 cm
15-022 20 cm



Duval Grasp Forceps
15-023 23 cm

INTESTINAL & TISSUE GRASPING FORCEPS

Darm-und Gewebefasszangen | Pincas Pour Saisir Intestins et Tissus
 Pinzas Para Intestinos y Tejidos | Pinze Per Afferrare Intestino e Tessuti



Babcock Seizing Forceps



- 15-024 16 cm
- 15-025 18 cm
- 15-026 20 cm
- 15-027 22 cm

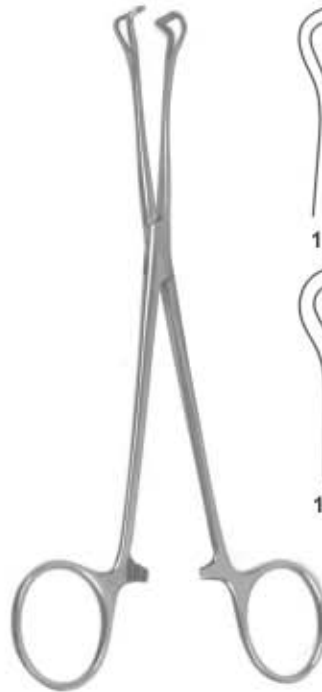

Babcock Tissue Grasping Forceps



Babcock Tissue Grasping Forceps
 15-030 18 cm
 15-031 24 cm

MANZIM
 SURGICO



Collin Grasp Forceps
 15-032 14 cm



Collin Tissue Grasping Forceps
 15-033 19.5 cm



Collin Tissue Grasping Forceps
 15-034 23 cm

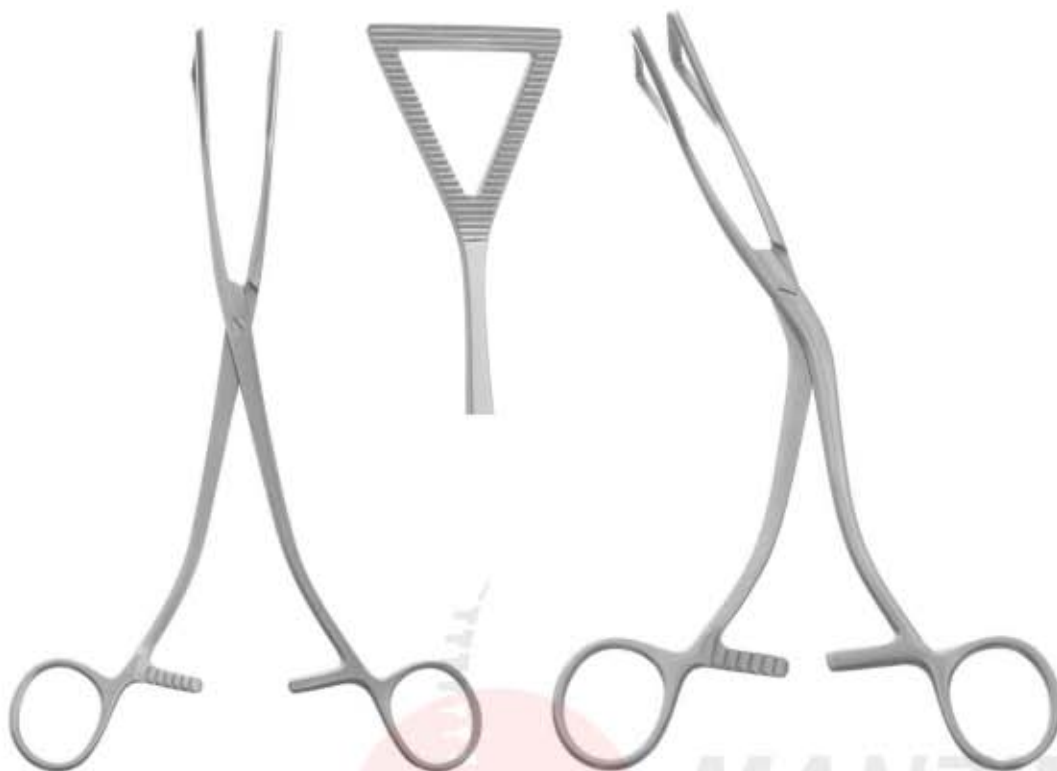

Duval Lung Tissue Forceps
15-035 1" WIDE
DeBakey type jaw, 23 cm

Lovelace Lung Tissue Forceps
15-036 1" WIDE
Angled on Side,
DeBakey type jaw, 19 cm

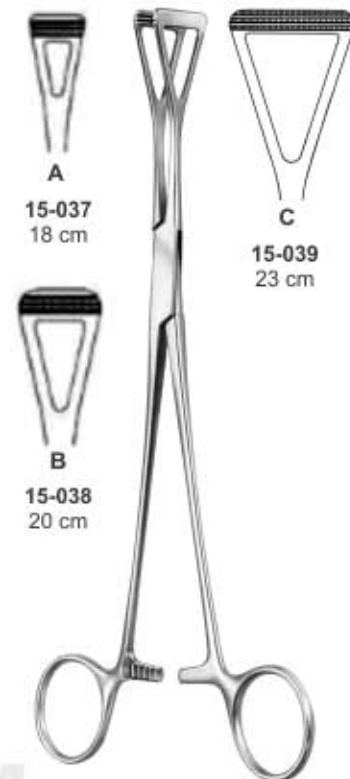

A
15-037
18 cm

B
15-038
20 cm

C
15-039
23 cm

Scheibe
Organ Grasping Forceps



Heywood-Smith
15-040
Polypus Grasping Forceps
21 cm

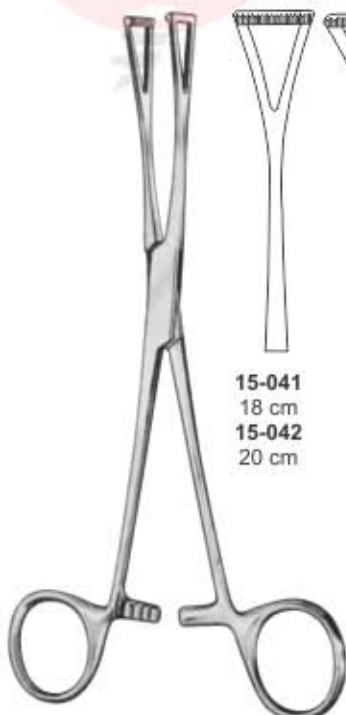

15-041
18 cm
15-042
20 cm

15-043
20 cm
15-044
23 cm

Duval Tissue Grasping Forceps

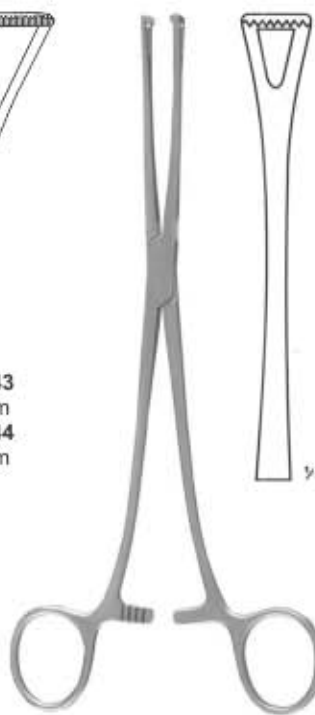

Lockwood Grasp Forceps
15-045 20 cm



Allen
Intestinal Clamp
15-046 16 cm

INTESTINAL & TISSUE GRASPING FORCEPS

Darm-und Gewebefasszangen | Pincas Pour Saisir Intestins et Tissus
 Pinzas Para Intestinos y Tejidos | Pinze Per Afferrare Intestino e Tessuti



Little Wood Tissue Grasping Forceps
 15-047 19 cm
 Box Joint



Lane Tissue Grasping Forceps
 15-048 12.5 cm
 15-049 15 cm
 15-050 19 cm



15-051
 25 cm
15-052
 27 cm

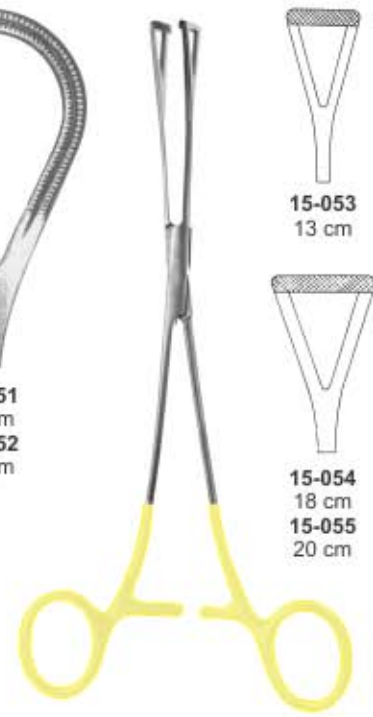

15-053
 13 cm



15-054
 18 cm
15-055
 20 cm

MANZIM SURGICO



Babcock Intestinal & Tissue Grasping Clamp Forceps T.C



15-056
 16.5 cm



15-057
 20.3 cm

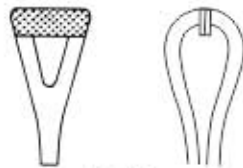

15-058
 17.5 cm

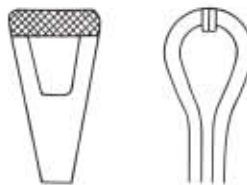

15-059
 19.5 cm



Stone-Watt
 15-060
 15cm
 Closing Forceps

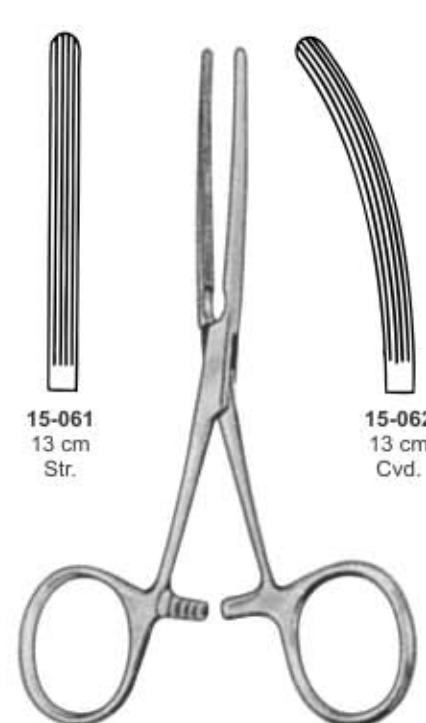

15-061
 13 cm
 Str.

15-062
 13 cm
 Cvd.

Baby-Kocher Intestinal Forceps Clamps

INTESTINAL CLAMPS

Darmklemmen | Pincas Intestinales
Pinzas Intestinales | Pinze Intestinali

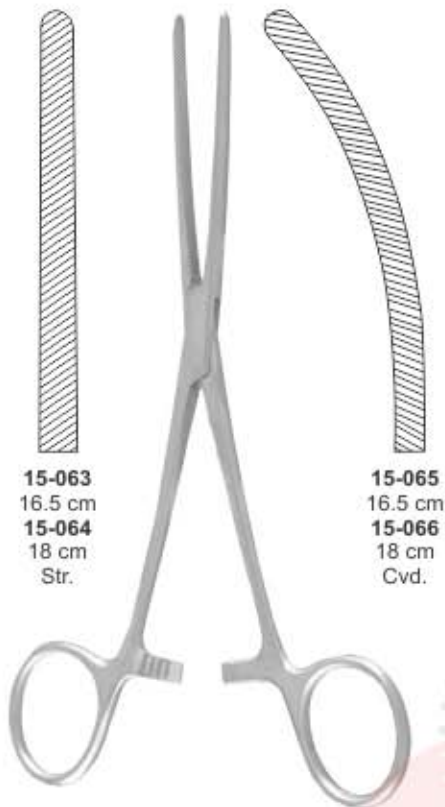

15-063
16.5 cm
15-064
18 cm
Str.

15-065
16.5 cm
15-066
18 cm
Cvd.

Baby-Doyen Intestinal Forceps Clamps

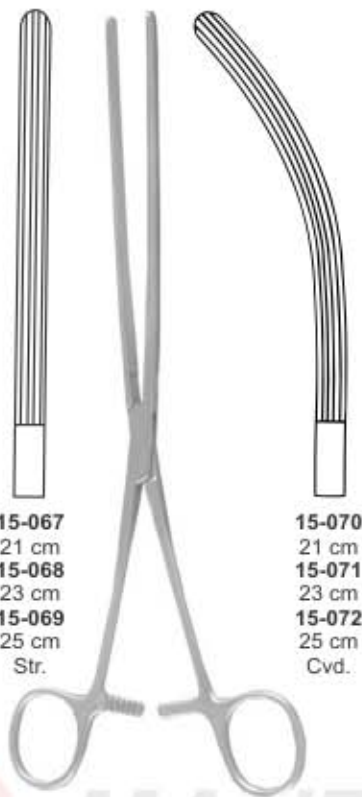

15-067
21 cm
15-068
23 cm
15-069
25 cm
Str.

15-070
21 cm
15-071
23 cm
15-072
25 cm
Cvd.

Mayo-Robson Intestinal Forceps Clamps

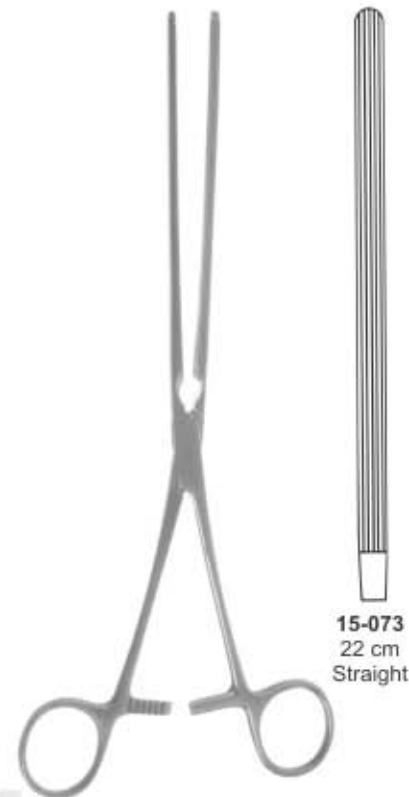

15-073
22 cm
Straight

Kocher Intestinal Forceps Clamps

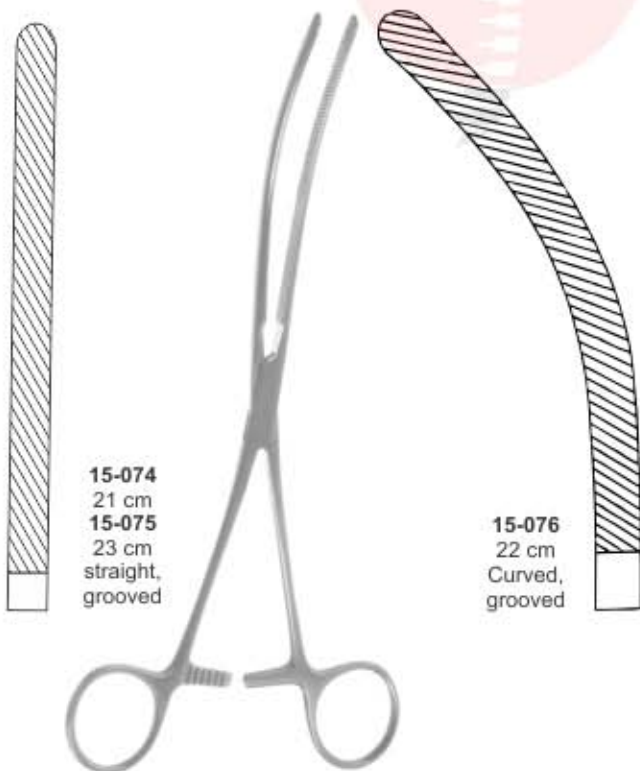

15-074
21 cm
15-075
23 cm
straight,
grooved

15-076
22 cm
Curved,
grooved

Doyen Intestinal Forceps Clamps



15-077 13 cm
15-078 15 cm
15-079 17 cm
15-080 21 cm
15-081 23 cm

Doyen-Baby Intestinal Clamp



Mayo Vessel Clamp
15-082 25.5cm
Curved, 3.8cm
tip

INTESTINAL CLAMPS

Darmklemmen | Pincas Intestinales
 Pinzas Intestinales | Pinze Intestinali



15-083
25 cm
Str.



15-084
25 cm
Cvd.

Mayo-Robson
Intestinal Clamp



15-085
13 cm
15-086
15 cm
15-087
17 cm
15-088
21 cm
15-089
23 cm

Doyen-Baby
Intestinal Clamp

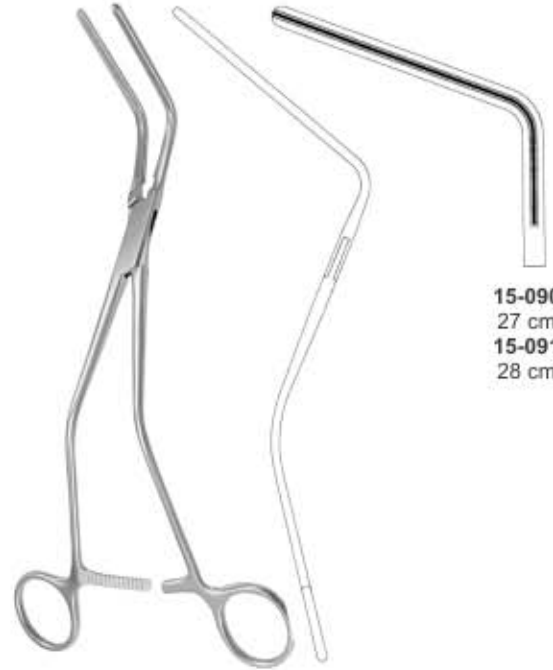

15-090
27 cm
15-091
28 cm

Hayes
Sigmoid Anastomosis Forceps

MANZIM
SURGICO

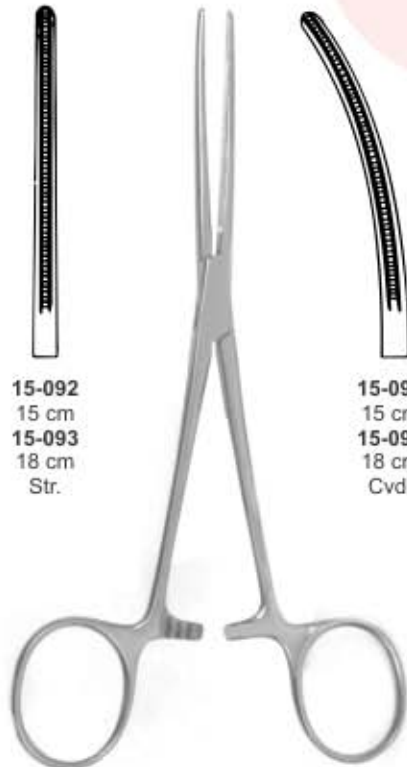

15-092
15 cm
15-093
18 cm
Str.

15-094
15 cm
15-095
18 cm
Cvd.

Bainbridge Intestinal
Forceps Clamps

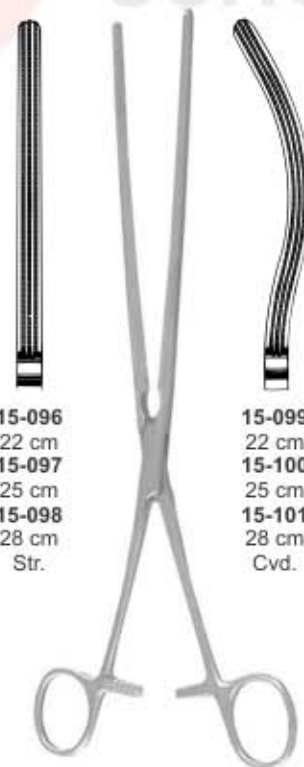

15-096
22 cm
15-097
25 cm
15-098
28 cm
Str.

15-099
22 cm
15-100
25 cm
15-101
28 cm
Cvd.

Kocher Intestinal Forceps
Clamps



15-102 13 cm
15-103 16 cm
15-104 18 cm
15-105 21 cm
15-106 23 cm
Str.

Doyen Intestinal
Forceps Clamps

Polypenfasszange, Darm-anastomosenklemmen

Pince Pour Saisir Polypes, Pincas-clamps Pour Anastomose Intestinale

Pinza Para Coger Pólipos, Clamps Para Anastomosis Intestinales

Pinze Per Afferrare Polipi, Pinze Per Anastomosi Intestinali



Doyen Intestinal Forceps Clamps

- 15-107 13 cm
- 15-108 16 cm
- 15-109 18 cm
- 15-110 21 cm
- 15-111 23 cm Cvd.



Scudder Intestinal Forceps Clamps

- 15-112 25 cm
- 15-113 33 cm Cvd.



- 15-114 25 cm
- 15-115 33 cm Str.

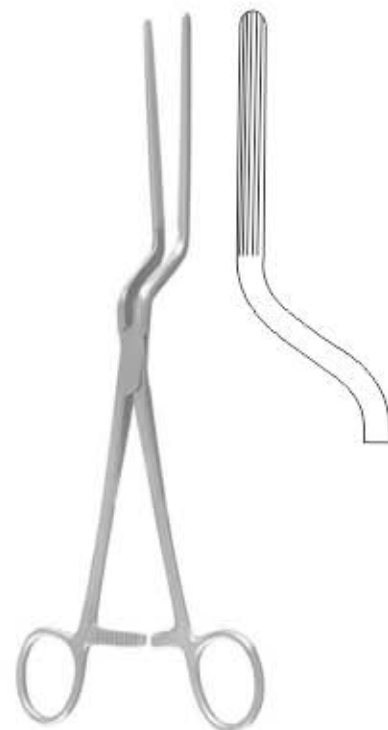

Brunner Intestinal Polyous Grasping Forceps
15-116 24 cm



Resano Intestinal Polyous Grasping Forceps
15-117 30 cm



Fehland Intestinal Polyous Grasping Forceps
15-118 24 cm



Nussbaum Intestinal Forceps Clamps

- 15-119 25 cm Cvd.



- 15-120 25 cm Str.



- 15-121 30cm Str.

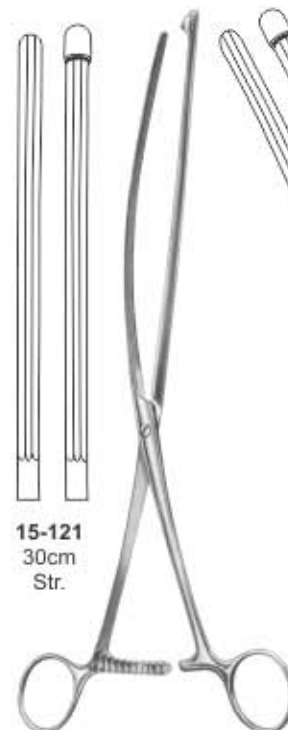

Nussbaum Stomach Intestinal Twin Clamp Forceps



- 15-122 30cm Cvd.



Darmklemmen	Pinces Intestinales
Pinzas Intestinales	Pinze Intestinali

Intestinal & Stomach Twin Clamp Forceps



**Haberer Stomach Intestinal
Twin Clamp Forceps**
15-123 36cm

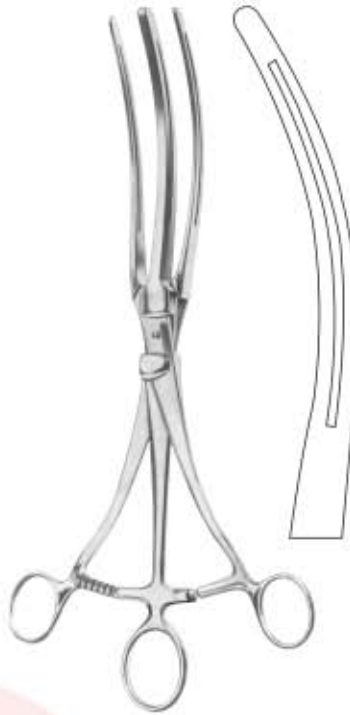
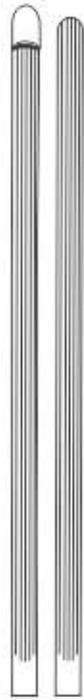

**Roosevelt Stomach Intestinal
Twin Clamp Forceps**
15-124 34cm

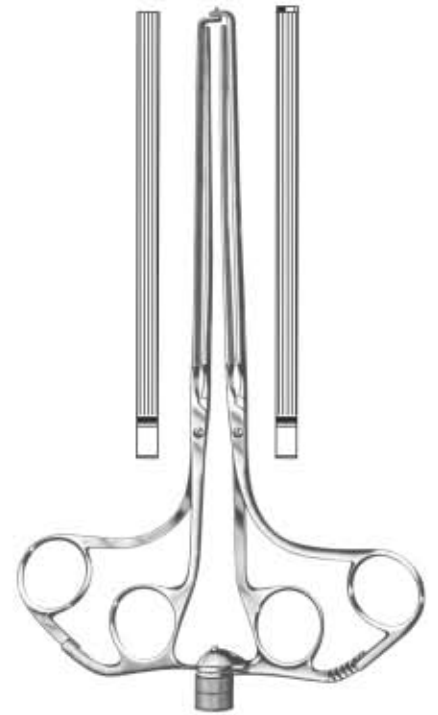

**Abadie Stomach Intestinal
Twin Clamp Forceps**
15-125 22cm
15-126 27cm



**Lane Stomach Intestinal
Clamp Forceps**
15-127
30 cm Str.



**Lane Stomach Intestinal
Clamp Forceps**
15-128
30 cm Cvd.

Polypenfasszange, Darm-anastomosenklemmen

Pince Pour Saisir Polypes, Pincés-clamps Pour Anastomose Intestinale

Pinza Para Coger Pólipos, Clamps Para Anastomosis Intestinales

Pinze Per Afferrare Polipi, Pinze Per Anastomosi Intestinali

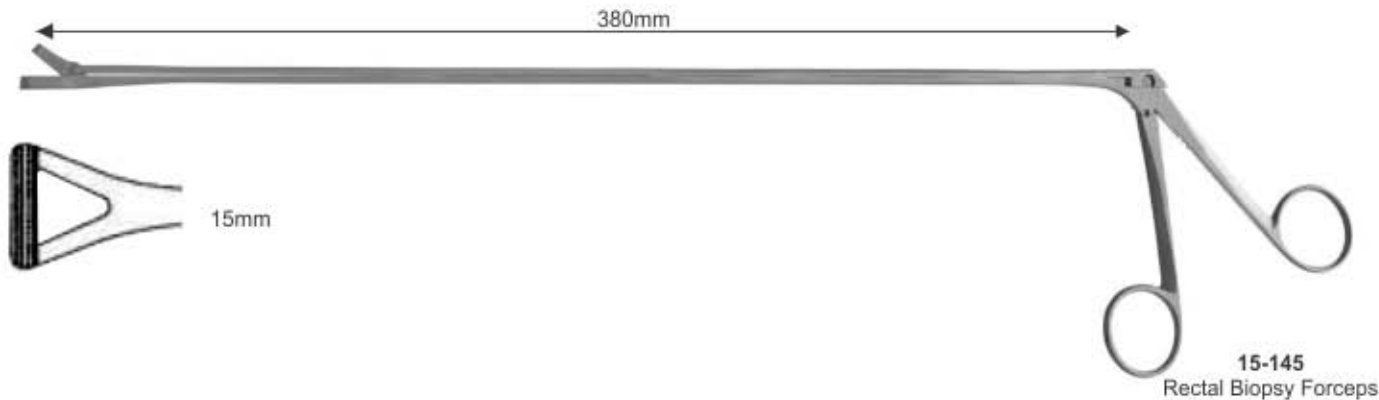
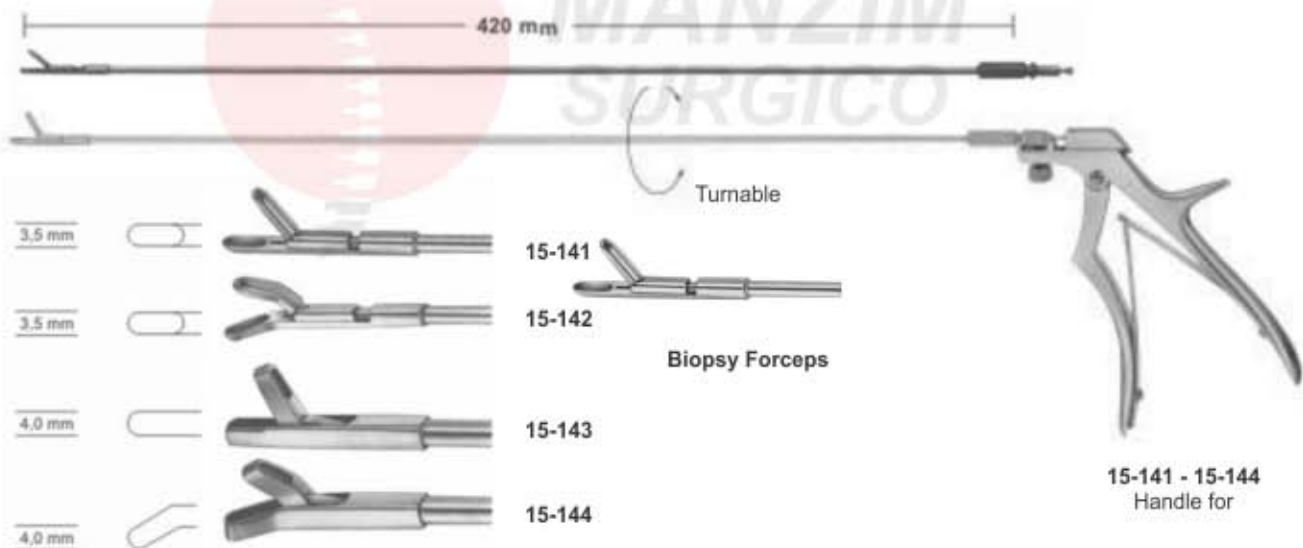
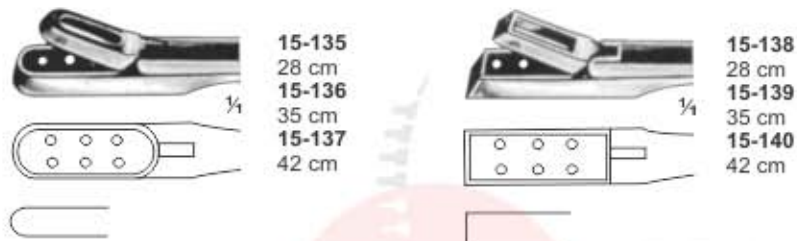
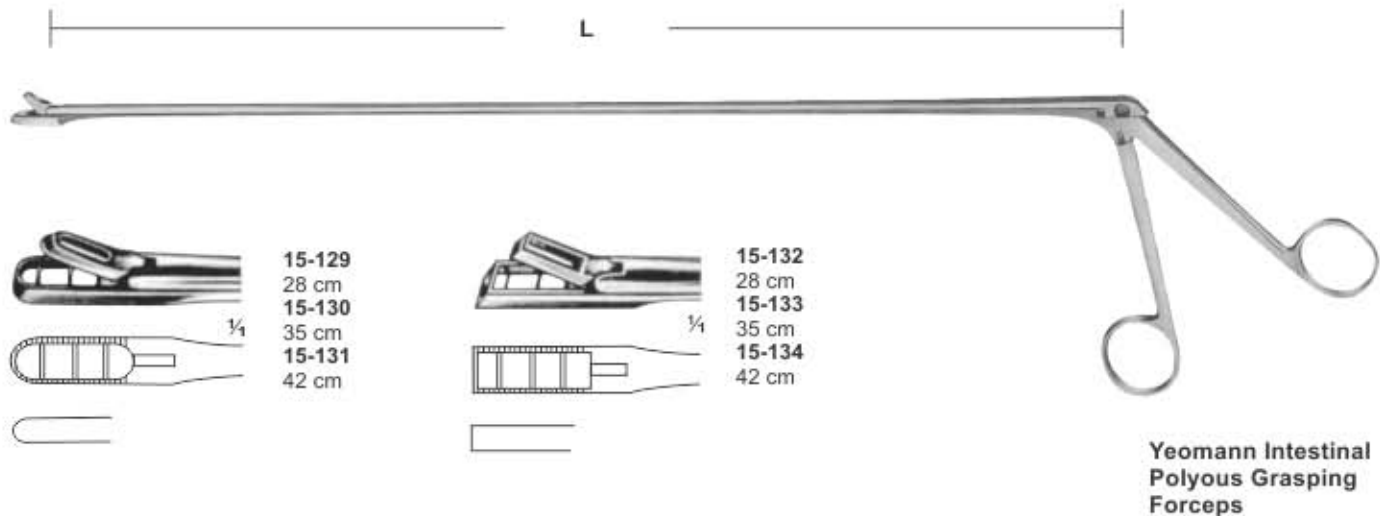

POLYOUS GRASPING FORCEPS, ANASTOMOSIS

Polypenfasszange, Darm-anastomosenklemmen

Pince Pour Saisir Polypes, Pincas-clamps Pour Anastomose Intestinale

Pinza Para Coger Pólipos, Clamps Para Anastomosis Intestinales

Pinze Per Afferrare Polipi, Pinze Per Anastomosi Intestinali



**De Martel-Wolfson
Clamp Holder**
15-146 8.5 cm



**De Martel-Wolfson
Clamp Holder**
15-147 23 cm



**Stone-Watt
Intestinal Anastomosis Clamp**
15-148 8.5cm
15-149 10cm



**De Martel-Wolfson
15-150 set of 3
anastomosis clamps**



Jaw length
15-151
5 cm



Jaw length
15-152
7 cm



Jaw length
15-153
10 cm



**De Martel-Wolfson
Closing Forceps**
15-154
26 cm

INTESTINAL CLAMPS

Darmklemmen	Pinces Intestinales
Pinzas Intestinales	Pinze Intestinali



Payr-Baby Crushing Intestinal Clamp
15-155
 15 cm
 without pin
15-156
 15 cm
 with pin

Payr Crushing Intestinal Clamp
15-157
 21 cm
 without pin
15-158
 21 cm
 with pin

Payr Crushing Intestinal Clamp
15-159
 29 cm
 without pin
15-160
 29 cm
 with pin

Payr Crushing Intestinal Clamp
15-161
 35 cm
 without pin
15-162
 35 cm
 with pin

INTESTINAL RECTAL SPECULA

Mastdarmspekula | Spéculums Rectaux
Especulos Rectales | Specoli Rettali



90 x 15 mm

Mathieu Rectal Speculum
15-163 19 cm
90 x 15 mm



Sims Rectal Speculum
15-164 15 cm



Sims Rectal Speculum
15-165 15 cm



Ives-Fansler Rectal Speculum
15-166 14.5 cm
22 mm Ø



Pratt Rectal Speculum
15-167 21.5 cm
85 x 25 mm blade

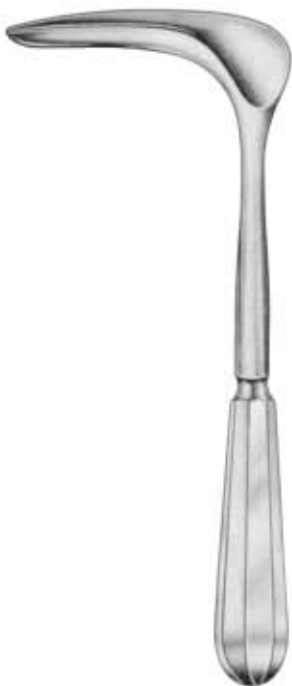

Czerny Rectal Speculum
15-168
22 cm



Barr Rectal Speculum
15-169 80mm
Blade size



Smith-Blue Intestinal Rectal Speculum
15-172 15 cm
75 x 23 mm



15-170
for extra blades

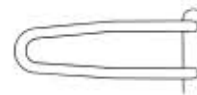

15-173 22 cm
20 x 65 mm
15-174 22 cm
25 x 85 mm
15-175 22 cm
25 x 120 mm
15-176 22 cm
23 x 145 mm



Alan-Parks
15-171
Alan-Parks
14 cm



Schulze-Bergmann Intestinal Rectal Speculum



Hirschmann Intestinal Rectal Speculum
15-177
23 mm Ø
proctoscope
working length: 145 mm



15-178
22 Ø x 50 mm
15-179
22 Ø x 100 mm
15-180
22 Ø x 140 mm
15-181
22 Ø x 200 mm

Kelly Intestinal Rectal Speculum

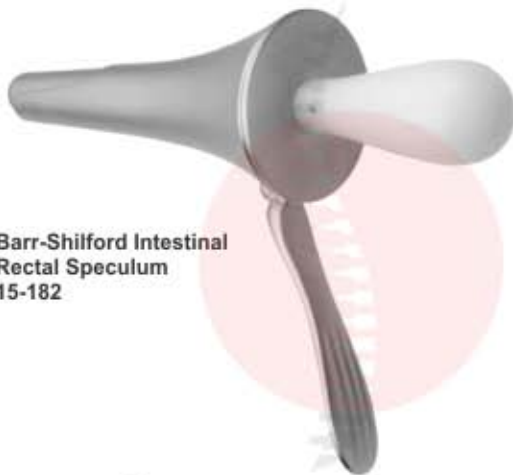

Barr-Shilford Intestinal Rectal Speculum
15-182



Vernon-David Intestinal Rectal Speculum
with thumb grip handle
15-183 short handle
15-184 long (standard) handle



Bensaude Intestinal Rectal Speculum
15-185 19 Ø x 70 mm
15-186 22 Ø x 70 mm



Brinkerhoff Intestinal Rectal Speculum
15-187 smal 89 x 25mm tapers to 13mm
15-188 medium 101 x 25mm tapers to 15mm
15-189 large 120 x 31mm tapers to 19mm

MANZIM
SURGICO

Mastdarmspekula
Especulos Rectales

Spéculums Rectaux
Specoli Rettali



Fansler Operating Intestinal Rectal Speculum

with slotted / extra long handle standard

- 15-190 25 mm x 65 mm
- 15-191 29 mm x 65 mm
- 15-192 38 mm x 70 mm

with slotted tube / short handle
15-193 29 mm x 60 mm
15-194 operating speculum



Chelsea-Eaton Intestinal Rectal Speculum

solid handle

- 15-195 small
 - 15-196 large
- with light connection available



Hirschman Anoscope Intestinal Rectal Speculum

- 15-197 small
57 x 14mm inside diameter
- 15-198 medium
52 x 17mm inside diameter
- 15-199 large
89 x 22mm inside diameter



Buie Hirschman Anoscope Intestinal Rectal Speculum

- 15-200 small
57 x 14mm inside diameter
- 15-201 medium
95 x 19mm inside diameter
- 15-202 large
98 x 25mm inside diameter



Ives-fansler Anoscope Intestinal Rectal Speculum

- with hard rubber obturator / fenestrated handle
- 15-203 22 mm x 85 mm



Long Chrome Handle Intestinal Rectal Speculum

- 15-204 81 x 29mm



Morgen Proctoscope Intestinal Rectal Speculum

- with light connection
- 15-205 17mm
- 15-206 20mm
- 15-207 24mm



Kelly Proctoscope Intestinal Rectal Speculum

- chrome plated
- 15-208 22mm x 50 mm
- 15-209 22mm x 100 mm
- 15-210 22mm x 145 mm



Hemorrhoidal Ligator-Suction
15-211

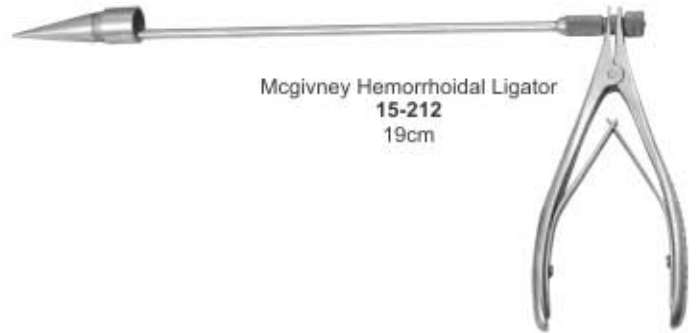

McGivney Hemorrhoidal Ligator
15-212
19cm



15-213
Rudd Hemorrhoidal Ligator with loading cone 12mmØ
31.5 cm Str.

15-214
Rudd Hemorrhoidal Ligator with loading cone 12mmØ
31.5 cm Cvd.

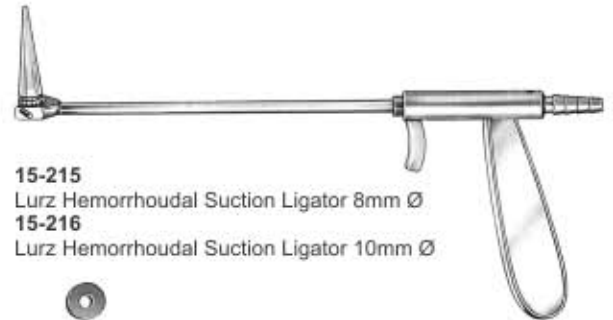

15-215
Lurz Hemorrhoidal Suction Ligator 8mm Ø
15-216
Lurz Hemorrhoidal Suction Ligator 10mm Ø

15-217
Ligator rubber rings
in package of 100 pieces



15-218
McGivney Hemorrhoid Grasping Forceps
19 cm angled shank.



15-219
McGivney Hemorrhoidal Ligator
With Offset Handle 18 cm
Working Length.



McGivney Hemorrhoidal Ligator
Complete Set
15-220

<i>Mastdarmspekula</i>	<i>Spéculums Rectaux</i>
<i>Espéculos Rectales</i>	<i>Specoli Rettali</i>

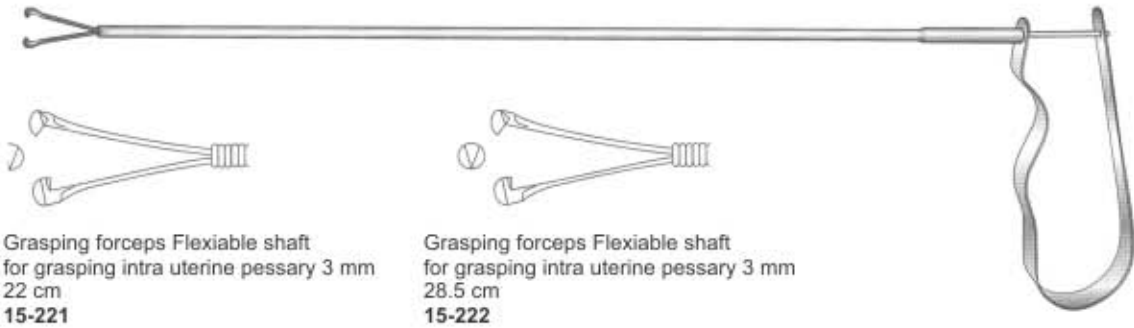

Grasping forceps Flexiable shaft
for grasping intra uterine pessary 3 mm
22 cm
15-221

Grasping forceps Flexiable shaft
for grasping intra uterine pessary 3 mm
28.5 cm
15-222

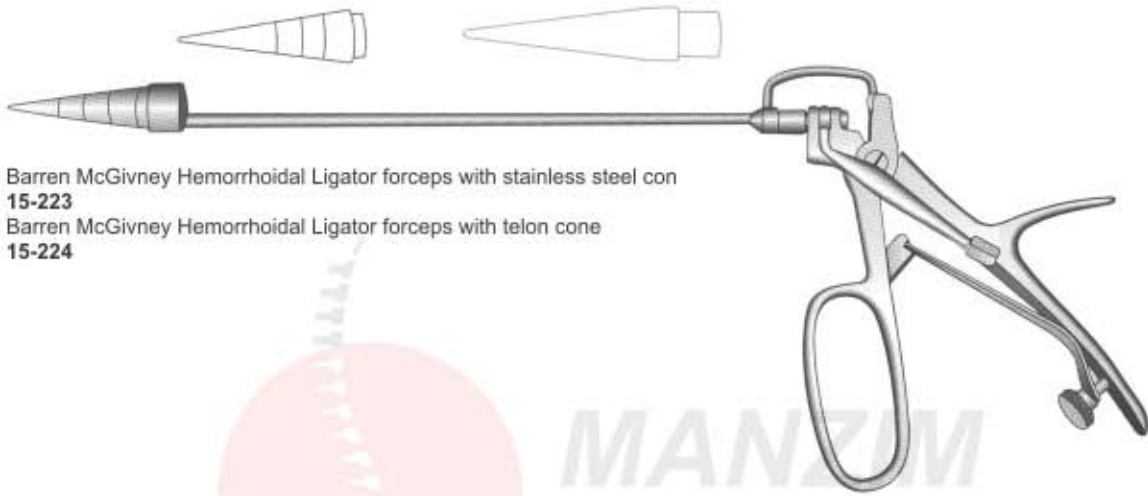

Barren McGivney Hemorrhoidal Ligator forceps with stainless steel con
15-223
Barren McGivney Hemorrhoidal Ligator forceps with telon cone
15-224

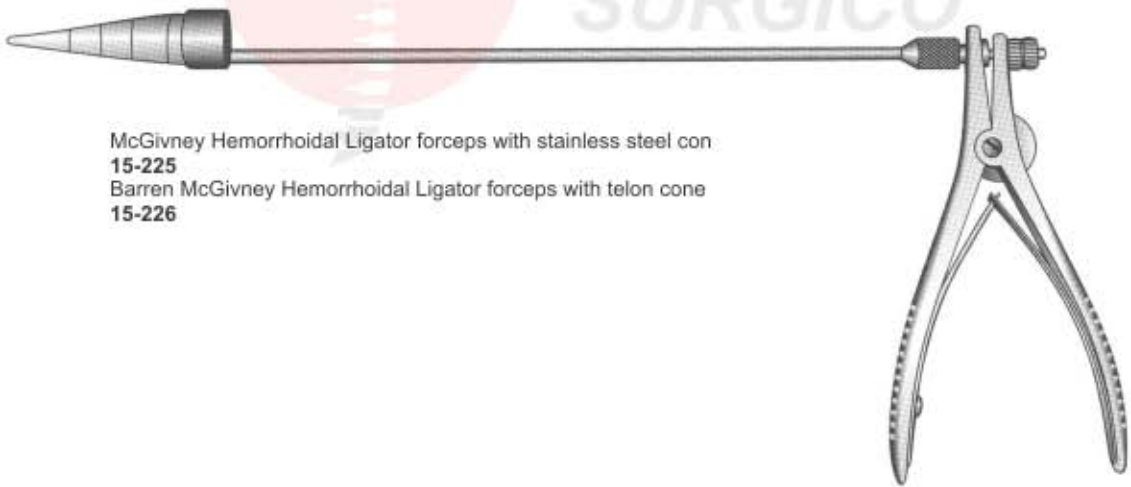

McGivney Hemorrhoidal Ligator forceps with stainless steel con
15-225
Barren McGivney Hemorrhoidal Ligator forceps with telon cone
15-226

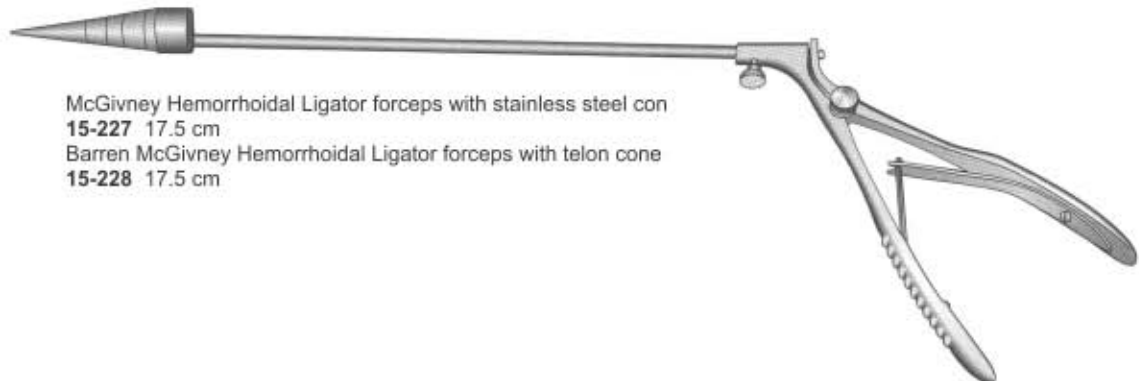

McGivney Hemorrhoidal Ligator forceps with stainless steel con
15-227 17.5 cm
Barren McGivney Hemorrhoidal Ligator forceps with telon cone
15-228 17.5 cm

KIDNEY STONE FORCEPS

Nierensteinzangen	Pinces pour les calculs du bassinnet
Pinzas para cálculoa renales	Pinze per calcoli renali



Randall Kidney Stone Clamps Forceps

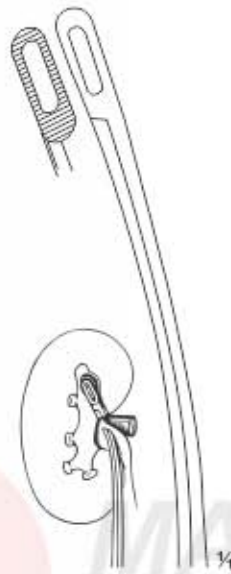

16-001
23 cm
quarter curved

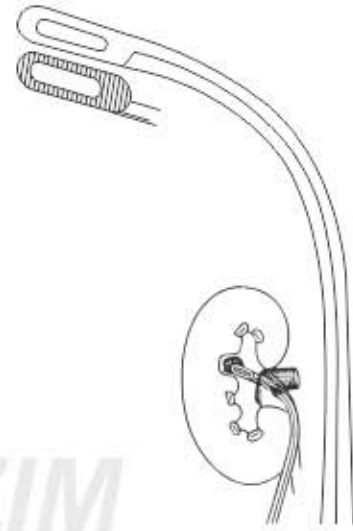

16-002
23 cm
half curved

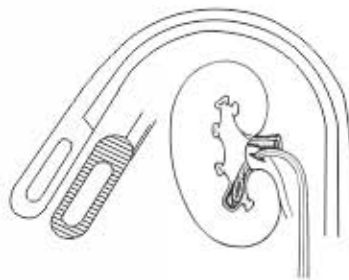

16-003
23 cm
full curved

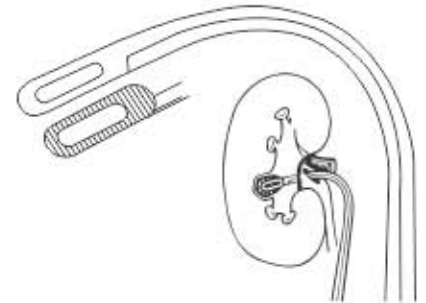

16-004
23 cm
three quarter curved

Nierensteinzangen
Pinzas para cálculoa renales

Pinces pour les calculs du bassin
Pinze per calcoli renali



16-005
23 cm



16-006
24.5 cm



Randall
Kidney Stone Forceps



Heiming
Kidney Stone Forceps



16-007
16 cm



16-008
17 cm

B



Elsasser
Nephrostomy Forceps



16-009
21 cm
Fig. 1

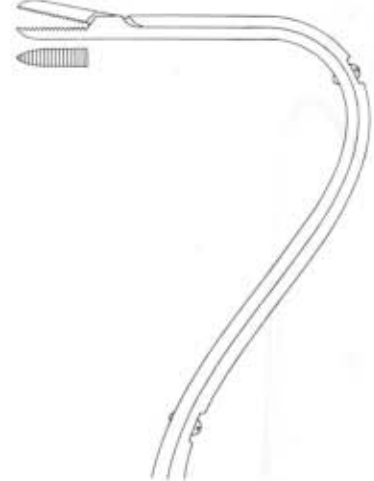

16-010
21 cm
Fig. 2

Nierensteinzangen	Pinces pour les calculs du bassinot
Pinzas para cálculoa renales	Pinze per calcoli renali



Dartigues Uterine Elevating Forceps
16-011 27 cm



Collin Kidney Elevating Stone Clamps Forceps
16-012 28.5 cm



Hulka-Kenwick Uterine Elevating & Manipulating Forceps
16-013 27 cm



Somer Kidney Elevating Stone Clamps Forceps
16-014 23.5 cm



Strassmann Kidney Elevating Stone Clamps Forceps
16-015 26 cm



Collin Kidney Elevating Stone Clamps Forceps
16-016 26.5 cm

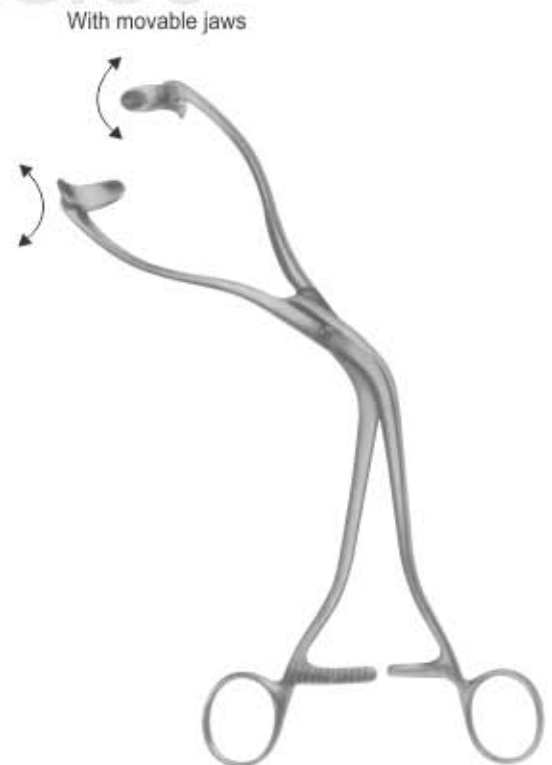

Collin Kidney Elevating Stone Clamps Forceps
16-017 26 cm

GALL STONE FORCEPS

Gallensteinzangen | Pincers pour calculs biliaires

Gallensteinlöffel | Curettes pour calculs biliaires



Blake Gall Stone Forceps
16-018 20 cm
Straight



Blake Gall Stone Forceps
16-019 21 cm
Curved



Mayo-Blake Gall Stone Forceps
16-020 20 cm
Straight



Mayo-Blake Gall Stone Forceps
16-021 20 cm
Curved

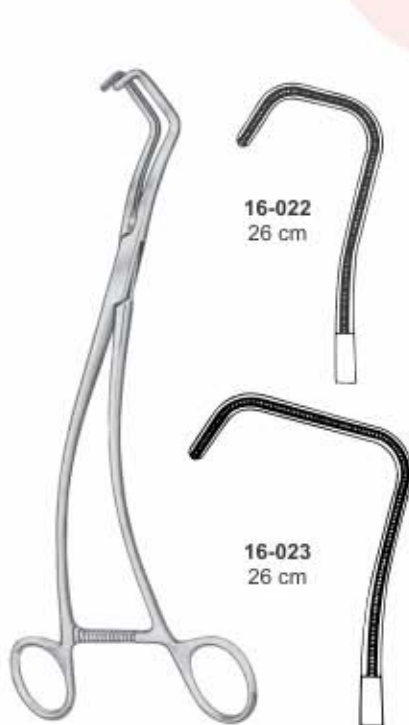

16-022
26 cm

16-023
26 cm

Uro-Tangential Gall Stone Forceps



Mixer Gall Stone Forceps
16-024 22 cm



Desjardins Gall Stone Forceps
16-025 23 cm



Desjardins Gall Stone Forceps
16-026 23 cm

Kapselasszangen, Fadenführungszange | *Pinces pour saisir les capsules, Pince porte-fil*
Pinzas capsulares, Pinza porta ligaduras | *Pinze per afferrare capsule, Pinza porta-filo*



16-027
24 cm

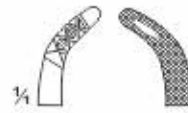

16-028
29 cm



16-029
23 cm

Harris Capsule Ligature Angled Suture Forceps

Johnson Prostatic Needle Holder

Stratte Needle Holder



Millin Prostatectomy Forceps
16-030 24 cm



Millin Prostatectomy Forceps
16-031 23 cm



Millin Vulsellum Forceps
16-032 23 cm



Millin Ligature Carrying Forceps Angular
16-033 23 cm

PROSTATIC RETRACTOR

Prostatahaken	Ecarteurs prostatiques
Separadores para próstata	Divaricatori prostatici

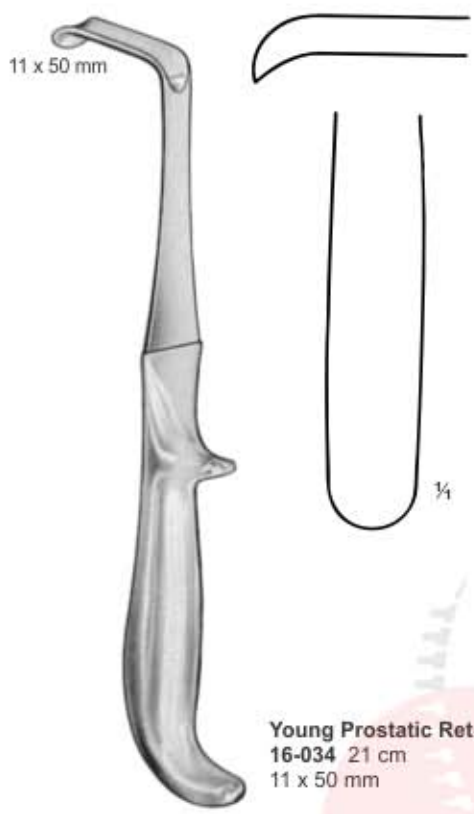

Young Prostatic Retractor
16-034 21 cm
11 x 50 mm



Young Prostatic Retractor
16-035 22 cm
38 x 64 mm

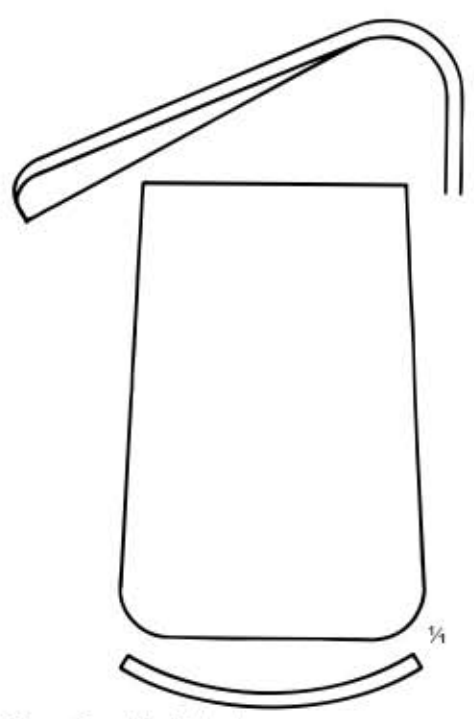

25 x 25 mm

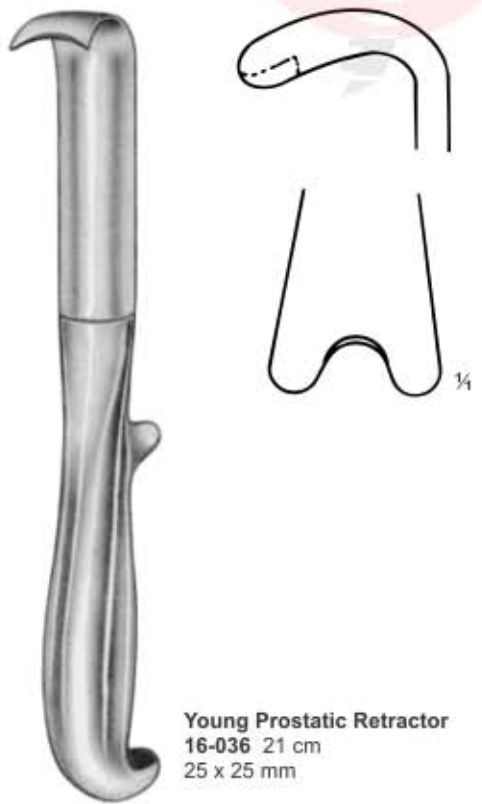

Young Prostatic Retractor
16-036 21 cm
25 x 25 mm



39 x 35 mm

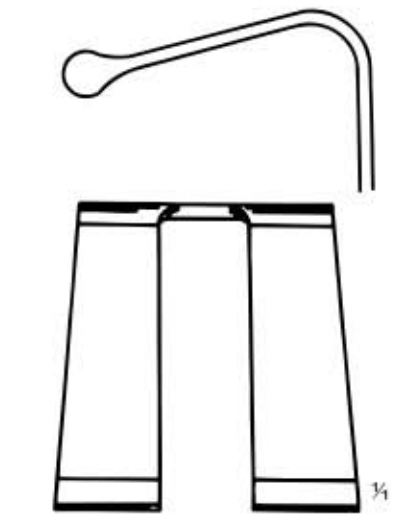

Young Prostatic Retractor
16-037 22 cm
39 x 35 mm

GALL DUCT DILATOR

Gallenkanaldilatatoren | Dilatateurs pour les voies biliaires
 Gallensteinzangen | Pinces pour calculs biliaires

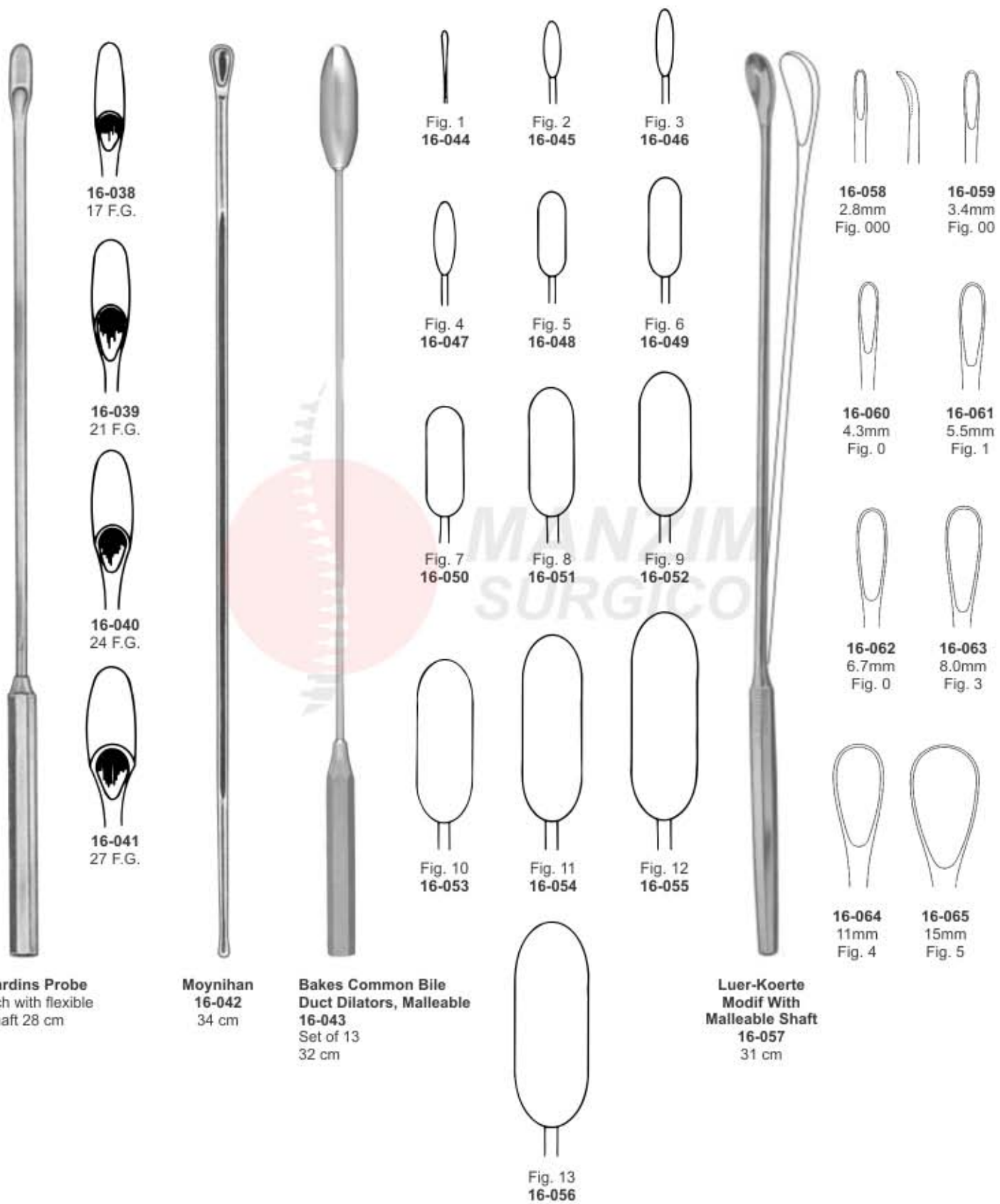

Desjardins Probe & Catch with flexible shaft
28 cm

Moynihan
16-042
34 cm

Bakes Common Bile Duct Dilators, Malleable
16-043
Set of 13
32 cm

Luer-Koerte Modif With Malleable Shaft
16-057
31 cm



Catheter
16-066
15 cm
No. 6-16



Catheters 29 cm
Male Catheters charr., Metal

French

- 16-067 8
- 16-068 10
- 16-069 12
- 16-070 14
- 16-071 16
- 16-072 18
- 16-073 20



Lister Bougies
16-074
27 cm
00 / 1 to 15 / 18
set of 17



Clutton Bougies
16-075 27 cm
06 / 10 FG to 28 / 32
set of 12



Van Buren
Urethral Sound
16-076
A to O
Set of 15

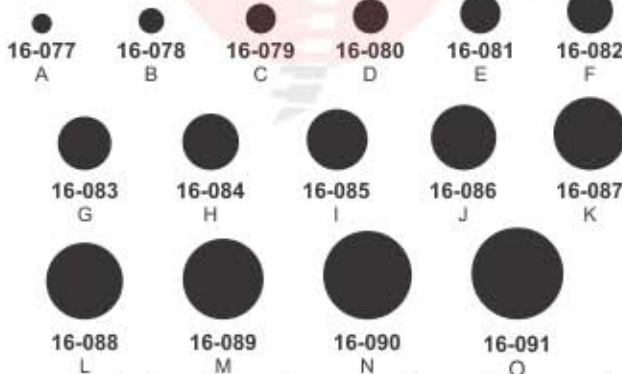
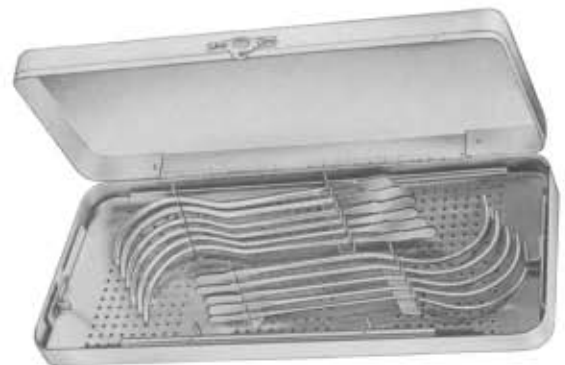

Fig.	Item	Description	Inches	Dia. Charr
A	16-077	28 cm	11"	8 French
B	16-078	28 cm	11"	10 French
C	16-079	28 cm	11"	12 French
D	16-080	28 cm	11"	14 French
E	16-081	28 cm	11"	16 French
F	16-082	28 cm	11"	18 French
G	16-083	28 cm	11"	20 French
H	16-084	28 cm	11"	22 French
I	16-085	28 cm	11"	24 French
J	16-086	28 cm	11"	26 French
K	16-087	28 cm	11"	28 French
L	16-088	28 cm	11"	30 French
M	16-089	28 cm	11"	32 French
N	16-090	28 cm	11"	34 French
O	16-091	28 cm	11"	36 French



Guyon
16-092
420 x 175 x 40 mm
Set in metal case containing:
— 21 Bougies Guyon
— 6 filiform Bougies

Urethalkatheter | Cateteri Uretrali
Sondes Urétrales | Catéteres Uretrales



Dittel
22.5 cm
urethral bougies and
dilating sounds

Charr. (French)	
16-093	8
16-094	9
16-095	10
16-096	11
16-097	12
16-098	13
16-099	14
16-100	15
16-101	16
16-102	17
16-103	18
16-104	19
16-105	20
16-106	21
16-107	22
16-108	23
16-109	24
16-110	25
16-111	26
16-112	27
16-113	28
16-114	29
16-115	30



Dittel
35 cm
urethral bougies and
dilating sounds

Charr. (French)	
16-116	8
16-117	9
16-118	10
16-119	11
16-120	12
16-121	13
16-122	14
16-123	15
16-124	16
16-125	17
16-126	18
16-127	19
16-128	20
16-129	21
16-130	22
16-131	23
16-132	24
16-133	25
16-134	26
16-135	27
16-136	28
16-137	29
16-138	30



33 cm
filiform guides,
olive tip

Charr. (French)	
16-139	3
16-140	4
16-141	5
16-142	6



Guyon
16-143
25 cm
Set
urethral bougies and
dilating sounds
without filiform guides,
with thread in tip

	Charr. (French)
16-144	Ben. 24 / Charr. 12 Ben. 25
16-145	Ben. 26 / Charr. 13 Ben. 27
16-146	Ben. 28 / Charr. 14 Ben. 29
16-147	Ben. 30 / Charr. 15 Ben. 31
16-148	Ben. 32 / Charr. 16 Ben. 33
16-149	Ben. 34 / Charr. 17 Ben. 35
16-150	Ben. 36 / Charr. 18 Ben. 37
16-151	Ben. 38 / Charr. 19 Ben. 39
16-152	Ben. 40 / Charr. 20 Ben. 41
16-153	Ben. 42 / Charr. 21 Ben. 43
16-154	Ben. 44 / Charr. 22 Ben. 45
16-155	Ben. 46 / Charr. 23 Ben. 47
16-156	Ben. 48 / Charr. 24 Ben. 49
16-157	Ben. 50 / Charr. 25 Ben. 51
16-158	Ben. 52 / Charr. 26 Ben. 53
16-159	Ben. 54 / Charr. 27 Ben. 55
16-160	Ben. 56 / Charr. 28 Ben. 57
16-161	Ben. 58 / Charr. 29 Ben. 59
16-162	Ben. 60 / Charr. 30

Blasenhalsperrer, Blasenwundsperrer

Ecarteur pour le col de la vessie, Ecarteurs vésicaux

Dilatador para el cuello vesical, Separadores vesicales

Divaricatore del collo vescicale, Divaricatore vescicale



Knutson
16-163 18 cm
Urethrographie-Instruments

16-164
Spare



Mogen Circumcision Clamp
16-165



Circumcision Shield
16-166 10cm



Winkelmann Circumcision Clamps
16-167 12 mm Ø
16-168 16 mm Ø
16-169 20 mm Ø

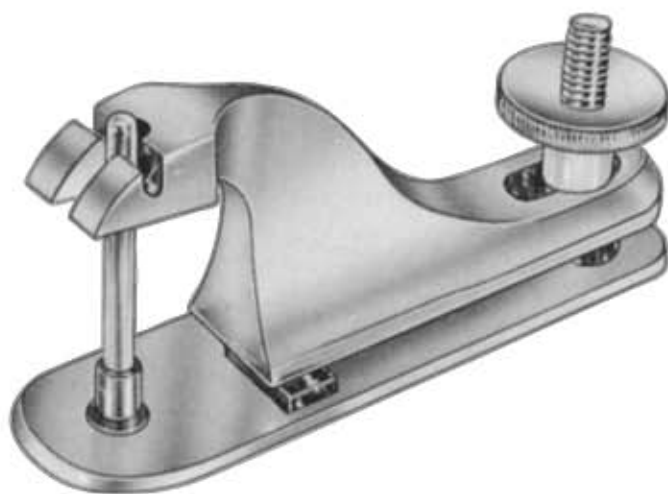

Gumco Circumcision Clamp
mm Ø
16-170 8
16-171 11
16-172 13
16-173 16
16-174 21
16-175 26
16-176 32



Stockmann Penile Clamp
16-177 8cm

BLADDER NECK SPREADER, BLADDER RETRACTORS

Blasenhalsperrer, Blasenwundsperrer

Ecarteur pour le col de la vessie, Ecarteurs vésicaux

Dilatador para el cuello vesical, Separadores vesicales

Divaricatore del collo vescicale, Divaricatore vescicale



Millin Bladder Neck Spreader
16-178
28 cm



Zieser Meaeus Clamp
16-179 10cm



Strauss Penile Clamp
16-180 11cm



Thomson Walker Penile Clamp
16-181

MANZIM
SURGICO



Lewkowitz Lithotomy Forceps
16-182 26cm Str.



Lewkowitz Lithotomy Forceps
16-183 26cm Cvd



Young Lobe Holding Forceps
16-184 20cm

Blasenhalsperrer, Blasenwundsperrer

Ecarteur pour le col de la vessie, Ecarteurs vésicaux

Dilatador para el cuello vesical, Separadores vesicales

Divaricatore del collo vescicale, Divaricatore vescicale



Legueu Bladder Spatula
16-185



Gosset Bladder Retractor
16-186 160mm



Thomson Walker Bladder Retractor
16-187

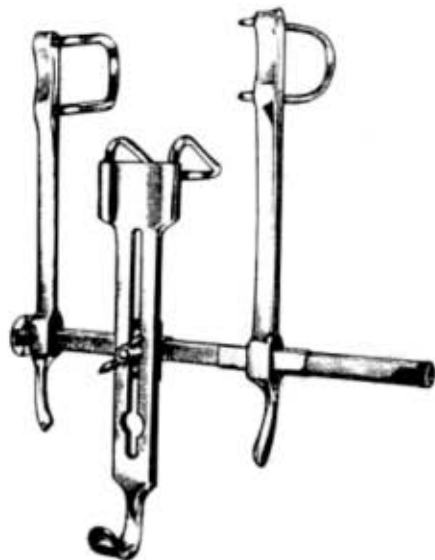

Pantings Bladder Retractor
16-188



Judd Masson Bladder Retractor
16-189
w/center blade



Millin Bladder Retractor
16-190

Leistenbruch Director, Vasektomie Zange, Schraubstock & Blase Retractor
Directora Hernia, Pinzas vasetomia, abrazadera y la vejiga retractor

Directeur de hernie, Pinces de vasetomie, Clamp et la vessie enroueur
Direttore Ernia, Pinze vasetomia, Clamp & vescica Divaricatore



Child Hernia Director
16-191



Key Hernia Director
16-192



Teale Hernia Director
16-193



Millin Suction Tube
16-194



Cord Hook
16-195
blunt 16cm



Gutmann Secretions Scoop
16-196 26cm



No Scalpel Vasectomy Ringed Forceps Clamps
16-197 14cm



No Scalpel Vasectomy Hemostat Forceps
16-198 14cm
smooth sharp point curved



Legueu Bladder Retractor
16-199
27cm



Kocher's Bladder Retractor
16-200 23.5 cm

RECTUM VASECTOMY SET OF 4 PCS
16-201



RECTUM VASECTOMY SET OF 4 PCS
16-202



RECTUM VASECTOMY SET OF 2 PCS
16-203



RECTUM VASECTOMY SET OF 3 PCS
16-204



RECTUM VASECTOMY SET OF 4 PCS
16-205

GYNECOLOGY/OBSTETRICS INSTRUMENTS



OBSTETRICS &
GYNAECOLOGY



Dilatation and Curettage

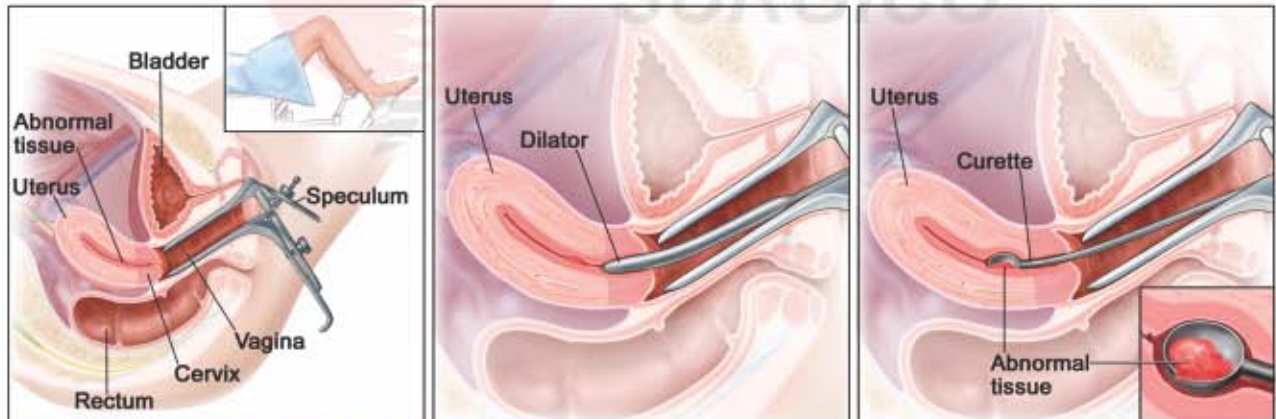



Cusco vaginal speculum
17-001 75 mm x 32 mm
17-002 85 mm x 35 mm
17-003 100 mm x 35 mm
17-004 75 mm x 17 mm
for virgines



Cusco vaginal speculum
17-005 75 mm x 32 mm
17-006 80 mm x 35 mm
17-007 100 mm x 37 mm



Cusco vaginal speculum
17-008 80 mm x 22 mm
17-009 100 mm x 25 mm
17-010 105 mm x 27 mm
Swiss pattern



Grave vaginal speculum
17-011 75 mm x 20 mm
17-012 95 mm x 35 mm
17-013 115 mm x 35 mm



Pederson vaginal speculum
17-014 75 mm x 13 mm
17-015 100 mm x 22 mm
17-016 120 mm x 25 mm



Winterton
17-017



Trolat vaginal speculum
17-018 85 mm x 30 mm
17-019 95 mm x 35 mm
17-020 115 mm x 43 mm



Vaginal Speculum Cusco
17-021 Extra Small
17-022 Small
17-023 Medium
17-024 Medium Extra long
17-025 Large



Semm vaginal speculum
17-026 90 mm x 14 / 18 mm
17-027 100 mm x 17 / 20 mm
17-028 110 mm x 25 / 30 mm

Scheidenspekulum | Espéculo vaginal
 Spéculum vaginal | Speculum vaginale



Collin vaginal speculum
 17-029 85 mm x 30 mm
 17-030 100 mm x 35 mm
 17-031 110 mm x 40 mm



COLLIN
 17-032
 55 x 10 mm



NOTT
 17-033 90 mm 30 mm
 17-034 100 mm 30 mm



DE VILBISS
 17-035
 4 x 27 mm
 102 mm x 32 mm
 Medium



SEYFFERT
 17-036 100 x 24 mm
 17-037 110 x 32 mm
 23 cm, 9"



CUSCO
 17-038 75 x 32 mm
 17-039 85 x 35 mm
 17-040 100 x 35 mm



CUSCO
 17-041 75 x 17 mm



CUSCO
 17-042 90 x 22 mm
 17-043 100 x 25 mm
 17-044 105 x 27 mm



GRAVES
 Virgin Speculaums
 Color Coated, Straight
 17-045 20mm x 75mm, Small
 17-046 35mm x 95mm, Medium
 17-047 35mm x 115mm, Large



Graves Vaginal Speculum Leep / Lietz
 17-048 Small
 17-049 Medium
 17-050 Large
 17-051 X-large



Pederson Vaginal Speculum Leep / Lietz
 17-052 Small
 17-053 Medium
 17-054 Large
 17-055 X-large



PEDERSON
 Virgin Speculaums
 Color Coated
 17-056 17mm x 100mm, Narrow
 17-057 13mm x 75mm, Small
 17-058 22mm x 100mm, Medium
 17-059 25mm x 120mm, Large

Vaginal Retraktoren
Écarteurs vaginaux

Retradores vaginales
Divaricatori vaginali



NEW PORT
17-060
25 cm



Lateral Vaginal Retractor
17-061
21 cm



Lateral Vaginal Retractor
Blue Coated Leep / Lietz
17-062 21 cm



Side Wall Retractors
17-063 4-Sided Pederson Speculum, Medium
17-064 4-Sided Pederson Speculum, Large
Redundant Wall Retractor, 3.5 in. x .75 in. blades
LateralWall Retractor, Closed Shanks, 2.25 in. blades
LateralWall Retractor, Open Shanks, 2.5 in. blades



Lateral Vaginal Retractor
Blue Coated
17-065 26cm



McGee Lateral Vaginal Retractor
With Ratchet Handle
17-066 20cm

Scheidenspekulum | Espéculo vaginal
 Spéculum vaginal | Speculum vaginale



**Kogan Speculum
 17-067**
 24 cm
 with scale-ratchet
 and fixation screw



**Kogan Speculum
 17-068**
 24 cm



**Kogan - Modif.
 Speculum**
 28 cm
17-069
 x=4 mm y=8mm
17-070
 x=2 mm y=4mm

MANZIM
 SURGICO



**Kogan Endocervical Spatula
 17-071**
 Ratchet, Standard Tips, 28cm
 Ratchet, Narrow Tips, 28cm
 Set Screw, Standard Tips, 28cm
 Set Screw, Narrow Tips, 28cm



**RAMATHIBODI
 17-072**
 27.5 cm
 Uterine Manipulator



**RAMATHIBODI
 17-073**
 25 cm
 Tubal hook



Kristeller Speculum
17-074 70 mm x 27 mm
17-075 80 mm x 30 mm
17-076 90 mm x 36 mm
17-077 110 mm x 27 mm
17-078 110 mm x 30 mm
17-079 110 mm x 36 mm



Kristeller Retractor
17-080 75 mm x 23 mm
17-081 85 mm x 26 mm
17-082 100 mm x 32 mm
17-083 115 mm x 23 mm
17-084 115 mm x 26 mm
17-085 115 mm x 32 mm



Kristeller Speculum & Retractor
17-086 75 mm x 23 mm
17-087 85 mm x 26 mm
17-088 100 mm x 32 mm
17-089 115 mm x 23 mm
17-090 115 mm x 26 mm
17-091 115 mm x 32 mm



Kristeller Speculum
17-092 105 mm x 18 mm
17-093 105 mm x 21 mm
 Speculum tapered, for virgins



Kristeller Retractor
17-094 110 mm x 14 mm
17-095 115 mm x 17 mm



Kristeller Speculum & Retractor
17-096 110 mm x 14 mm
17-097 115 mm x 17 mm

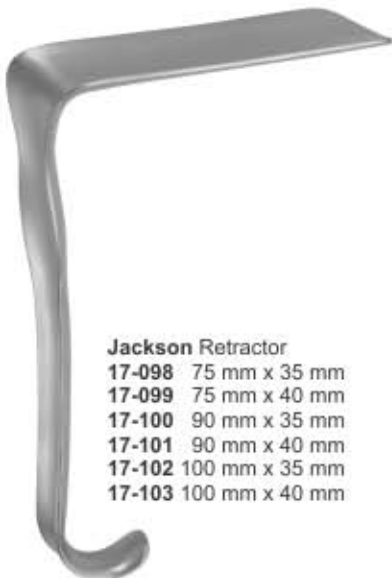

Jackson Retractor
17-098 75 mm x 35 mm
17-099 75 mm x 40 mm
17-100 90 mm x 35 mm
17-101 90 mm x 40 mm
17-102 100 mm x 35 mm
17-103 100 mm x 40 mm



Sims Speculum & Retractor
17-104 70 mm x 25 mm / 30 mm
17-105 75 mm x 30 mm / 35 mm
17-106 80 mm x 35 mm / 40 mm

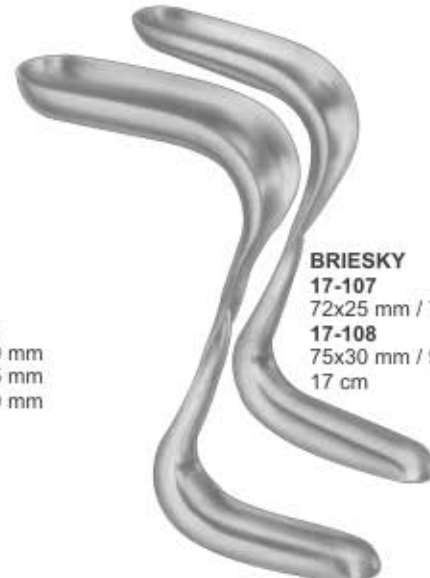

BRIESKY
17-107
 72x25 mm / 77x30 mm
17-108
 75x30 mm / 92x38 mm
 17 cm

Vaginalspekulum und Retraktoren
Spéculum et écarteurs vaginaux

Espéculo vaginal y retractores
Speculum vaginale e divaricatori



Kallmorgen Speculum
17-109 70 mm x 40 mm
17-110 90 mm x 40 mm



Kallmorgen & Retractor
17-111 70 mm x 33 mm
17-112 90 mm x 33 mm



Kallmorgen Speculum & Retractor
17-113 70 mm x 33 mm
17-114 90 mm x 33 mm



MATHIEU Vaginal Speculum
17-115
Set 100x13mm-23mm
17-116
95x16mm-26mm
17-117
95x26mm-30 mm
21 cm



MATHIEU Vaginal Retractor
17-118
Set 100x17mm-30mm
17-119
100x11mm-20mm
17-120
100x14mm-26mm
22 cm



Doyen Vaginal Speculum
22 cm



Slightly Concave

- 17-121 60 x 35 mm
- 17-122 90 x 35 mm
- 17-123 120 x 35 mm
- 17-124 60 x 45 mm
- 17-125 90 x 45 mm
- 17-126 120 x 45 mm
- 17-127 160 x 45 mm
- 17-128 60 x 60 mm
- 17-129 90 x 60 mm
- 17-130 120 x 60 mm
- 17-131 160 x 60 mm



Landon Vaginal Retractor
17-132
Blade 9 cm
Deep 2.5 cm wide.



BRAUN
17-133
18 cm



BRAUN
17-134
18 cm



17-135
Handle with cold light carrier for upper blades
28 cm



17-136
115 x 22 mm
17-137
115 x 26 mm

SIMON
115 x 22 mm
27.5 cm



Scheidenspekulum | Espéculo vaginal
 Spéculum vaginal | Speculum vaginale



**Scherback Speculum
 17-160**
 Set consisting of:
 handle weight 5 blades

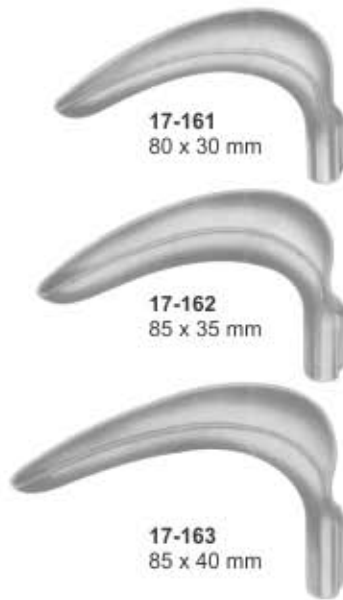

17-161
 80 x 30 mm

17-162
 85 x 35 mm

17-163
 85 x 40 mm



17-164
 55 x 40 - 60 mm

17-165
 70 x 45 - 70 mm



**Scherback Speculum
 17-166**
 Set consisting of:
 2 handle, 8 blades



17-167
 80 x 30 mm

17-168
 85 x 33 mm

17-169
 100 x 38 mm

17-170
 110 x 42 mm



17-171
 65 x 30 mm

17-172
 75 x 35 mm

17-173
 85 x 35 mm

17-174
 95 x 35 mm

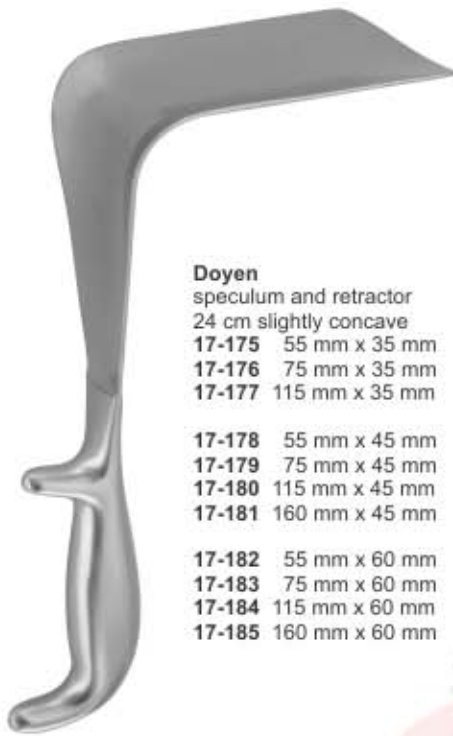

Doyen
speculum and retractor
24 cm slightly concave
17-175 55 mm x 35 mm
17-176 75 mm x 35 mm
17-177 115 mm x 35 mm

17-178 55 mm x 45 mm
17-179 75 mm x 45 mm
17-180 115 mm x 45 mm
17-181 160 mm x 45 mm

17-182 55 mm x 60 mm
17-183 75 mm x 60 mm
17-184 115 mm x 60 mm
17-185 160 mm x 60 mm



Doyen
speculum and retractor
24 cm medium concave
17-186 55 mm x 35 mm
17-187 75 mm x 35 mm
17-188 115 mm x 35 mm

17-189 55 mm x 45 mm
17-190 75 mm x 45 mm
17-191 115 mm x 45 mm

17-192 55 mm x 60 mm
17-193 75 mm x 60 mm
17-194 115 mm x 60 mm



DOYEN
Speculum & Retractor
23.5 cm



17-195
60 x 45 mm



17-196
90 x 45 mm



17-197
112 x 45 mm



MANZIM
SURGICO



Garrigue Weighted Vaginal Speculum
17-198 4.0 cm x 8.0 cm
Weight 2 lbs



Henrotin Weighted Vaginal Speculum
17-199 3.8 cm x 9.0 cm
Weight 3 lbs.



AUVARD,
speculum & retractor
17-200
80 x 38 mm - 28 mm
1,530 kg
with fixed weight
23 cm



AUVARD
speculum & retractor
17-201 75 x 42 mm
17-202 80- x 43 mm
(40 mm)
17-203 105 x 43 mm
(40 mm)
with detachable weight
23 cm



WEISSBARTH
speculum & retractor
17-204 80 x 28 mm
17-205 85 x 42 mm
21 cm

Scheidenspekulum | *Espéculo vaginal*
Spéculum vaginal | *Speculum vaginale*



AUVARD
17-206
 65 x 38 mm - 28 mm
 1,530 kg
 with fixed weight
 23 cm



MARTIN
17-207
 with hook shaped
 handle for hanging
 in weights
 27 cm



STEINER SPECULUM
 Ideal for deep vaginal surgery.
 Blades may be ordered from
 4" to 7", 5.5" is normal length.

17-208
 1.1 Kg / 2.5 lb:
 14 cm x 3 cm



HARDY-DUDDY SPECULUM
 It will not fall out. Design places the 3.5 lbs
 weight at a right angle to the shaft of the
 speculum, preventing expulsion. Many
 blade options are available.

17-209
Hardy-Duddy Speculum,
 3.5 lbs., 120 mm x 35 mm
 cupped blade



AUVARD SPECULUM
 An assortment of weighted
 Auvard specula is available.

17-210
 1.1 Kg / 2.5 lb:
 8.5 cm x 4 cm
17-211
 1.1 Kg / 2.5 lb:
 10 cm x 4.5 cm



**NICHOLS WEIGHTED
 SPECULUM**
 Permits retraction of posterior
 vaginal wall, while providing
 suction and measurement of
 fluids from the surgical site.

17-212
Nichols Vaginal Weighted Speculum
 with Suction, 2.5 lbs. 7cm x 3.8cm

VAGINAL RETRACTORS

Vaginal Retraktoren
Écarteurs vaginaux

Retradores vaginales
Divaricatori vaginali



O'Sullivan - O'Connor
Vaginal Retractor
17-213 Set of 3 Complete



17-214
45 x 17 mm



17-215
90 x 45 mm



17-216
90 x 37 mm



Abdominal Retractor
17-217 9 cm wide
17-218 10 cm wide
17-219 11.5 cm wide



Friedmann Retractor
17-220
10 cm



COMYN BERKELEY
Vulva Self Retaining

17-221
15.5cm



DOYEN
Supra Hollow Handle
17-222 7.5mm x 28cm
17-223 9mm x 28cm
17-224 10mm x 28cm
17-225 11.5mm x 28cm



DOYEN POZZI
Retractor
17-226 4.5mm x 5mm x 25.5cm
17-227 4.5mm x 9mm x 25.5cm
17-228 4.5mm x 11.5mm x 25.5cm

Probeexzisionszangen | Pinzas saca-bocados para biopsia
 Pincas emporte-pièces à biopsie | Pinze taglianti per biopsia



Berger
 Biopsy and Specimen Forceps
17-229
 x = 200 mm

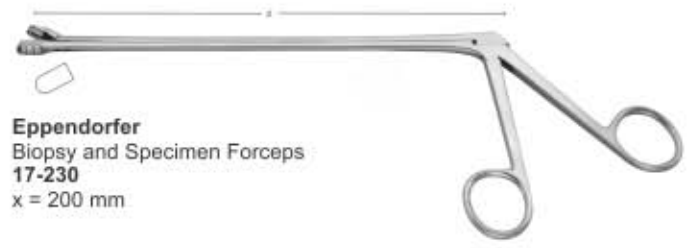

Eppendorfer
 Biopsy and Specimen Forceps
17-230
 x = 200 mm

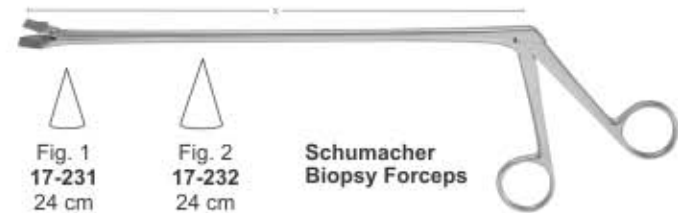

Fig. 1 **Fig. 2**
17-231 **17-232**
 24 cm 24 cm
Schumacher
Biopsy Forceps



Kevorkian
 Biopsy and Specimen Forceps
17-233
 x = 245 mm



Alexander
 Biopsy and Specimen Forceps
17-234 28 cm
 x = 200 mm

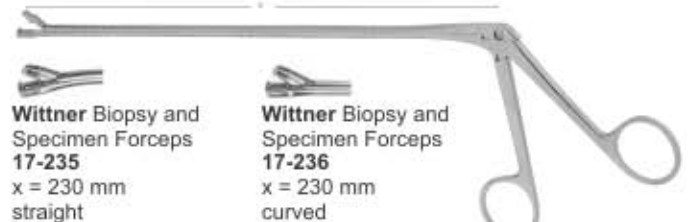

Wittner Biopsy and Specimen Forceps **Wittner Biopsy and Specimen Forceps**
17-235 **17-236**
 x = 230 mm x = 230 mm
 straight curved



Schumacher
 Biopsy and Specimen Forceps
17-237 **17-238**
 x = 23 cm x = 23 cm
 complete tip

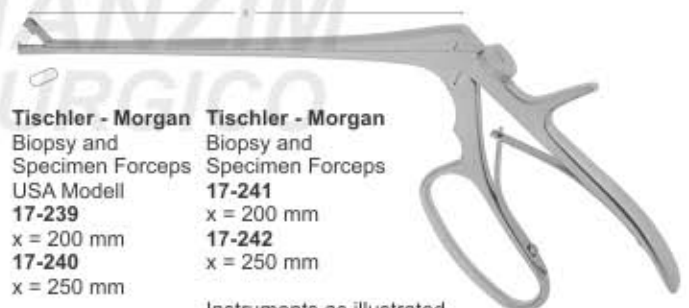

Tischler - Morgan **Tischler - Morgan**
 Biopsy and Specimen Forceps USA Modell Biopsy and Specimen Forceps USA Modell
17-239 **17-241**
 x = 200 mm x = 200 mm
17-240 **17-242**
 x = 250 mm x = 250 mm

Instruments as illustrated, but without locking screw. **USA Modell**

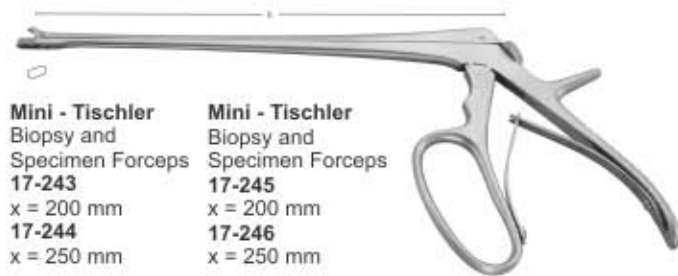

Mini - Tischler **Mini - Tischler**
 Biopsy and Specimen Forceps Biopsy and Specimen Forceps
17-243 **17-245**
 x = 200 mm x = 200 mm
17-244 **17-246**
 x = 250 mm x = 250 mm

Instruments as illustrated, but without locking screw.



Wittner Biopsy Forceps **Wittner Biopsy Forceps**
17-247 **17-248**
 23cm 23cm
 Shaft Straight Shaft Angled

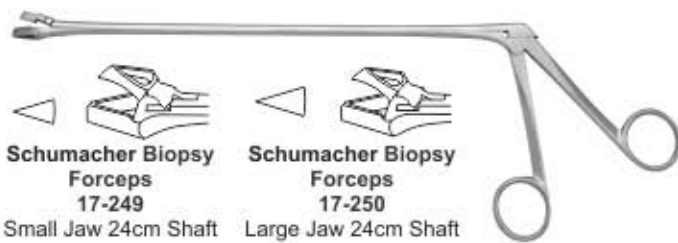

Schumacher Biopsy Forceps **Schumacher Biopsy Forceps**
17-249 **17-250**
 Small Jaw 24cm Shaft Large Jaw 24cm Shaft



Tischler Baby Biopsy Forceps
17-251
 21.5cm Shaft

Probeexzisionszangen

Pinzas saca-bocados para biopsia

Pinces emporte-pièces à biopsie

Pinze taglianti per biopsia



Tischler Biopsy Forceps
17-252
21.5cm Shaft



Burke Biopsy Forceps
17-253
21.5cm Shaft

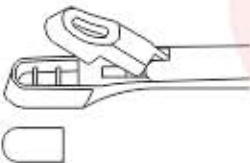

Eppendorf Biopsy Forceps
17-254
20cm Shaft

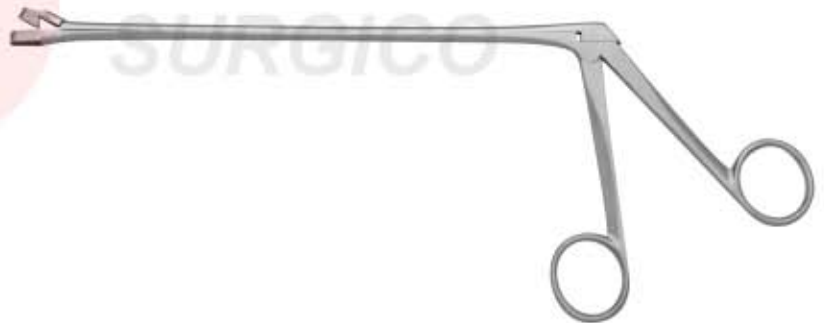

Kevorkian Young Biopsy Forceps
17-255
25.5cm Shaft

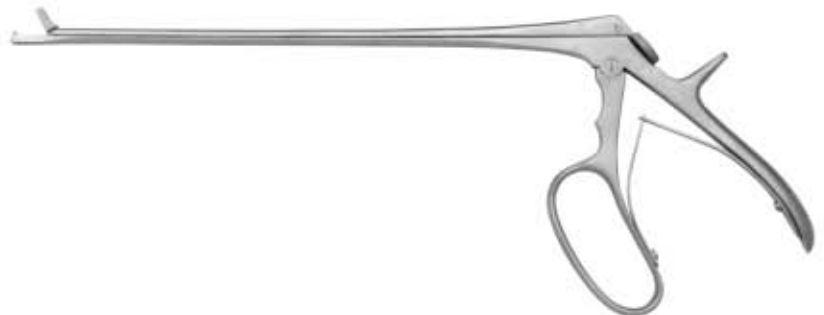

Leechwilkinson Biopsy Forceps
17-256
20cm Shaft Round



MANZIM
SURGICO

Probeexzisionszangen

Pinzas saca-bocados para biopsia

Pinces emporte-pièces à biopsie

Pinze taglianti per biopsia



Uni - Tischler
Biopsy and
Specimen Forceps
17-258
3 x 7 mm
Straight, Tip only



Uni - Tischler
Biopsy and
Specimen Forceps
17-259
3 x 7 mm
up, Tip only



Uni - Tischler
Biopsy and
Specimen Forceps
17-260
3 x 7 mm
down, Tip only

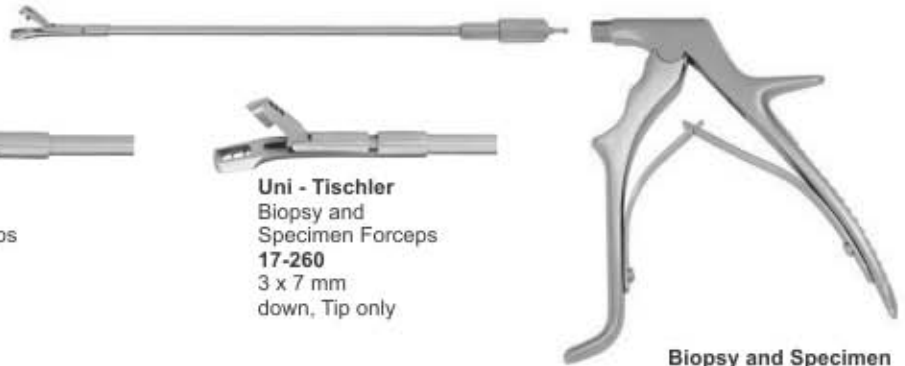

**Biopsy and Specimen
Forceps Handle only
17-257**



Uni - Townsend
Biopsy and
Specimen Forceps
17-261
2.3 x 4 mm
straight, Tip only



Uni - Townsend
Biopsy and
Specimen Forceps
17-262
2.3 x 4 mm
up, Tip only



Uni - Townsend
Biopsy and
Specimen Forceps
17-263
2.3 x 4 mm
down, Tip only



Uni - Kevorkian
Biopsy and
Specimen Forceps
17-264
3 x 9 mm
Tip only



Uni - Oval
Biopsy and
Specimen Forceps
17-265
3 x 5 mm
Tip only



Uni - Burke
Biopsy and
Specimen Forceps
17-266
3 x 5 mm
Tip only



Uni - Tischler
Biopsy and
Specimen Forceps
17-268
3 x 7 mm
Straight, Tip only



Uni - Tischler
Biopsy and
Specimen Forceps
17-269
3 x 7 mm
up, Tip only



Uni - Tischler
Biopsy and
Specimen Forceps
17-270
3 x 7 mm
down, Tip only



**Biopsy and Specimen
Forceps Handle only
17-267**



Uni - Townsend
Biopsy and
Specimen Forceps
17-271
2.3 x 4 mm
straight, Tip only



Uni - Townsend
Biopsy and
Specimen Forceps
17-272
2.3 x 4 mm
up, Tip only



Uni - Townsend
Biopsy and
Specimen Forceps
17-273
2.3 x 4 mm
down, Tip only

Uni - Kevorkian
Biopsy and
Specimen Forceps
17-274
3 x 9 mm
Tip only



Uni - Oval
Biopsy and
Specimen Forceps
17-275
3 x 5 mm
Tip only



Uni - Burke
Biopsy and
Specimen Forceps
17-276
3 x 5 mm
Tip only

Polypenfasszange, Darm-anastomosenklemmen

Pince Pour Saisir Polypes, Pinces-clamps Pour Anastomose Intestinale

Pinza Para Coger Pólipos, Clamps Para Anastomosis Intestinales

Pinze Per Afferrare Polipi, Pinze Per Anastomosi Intestinali

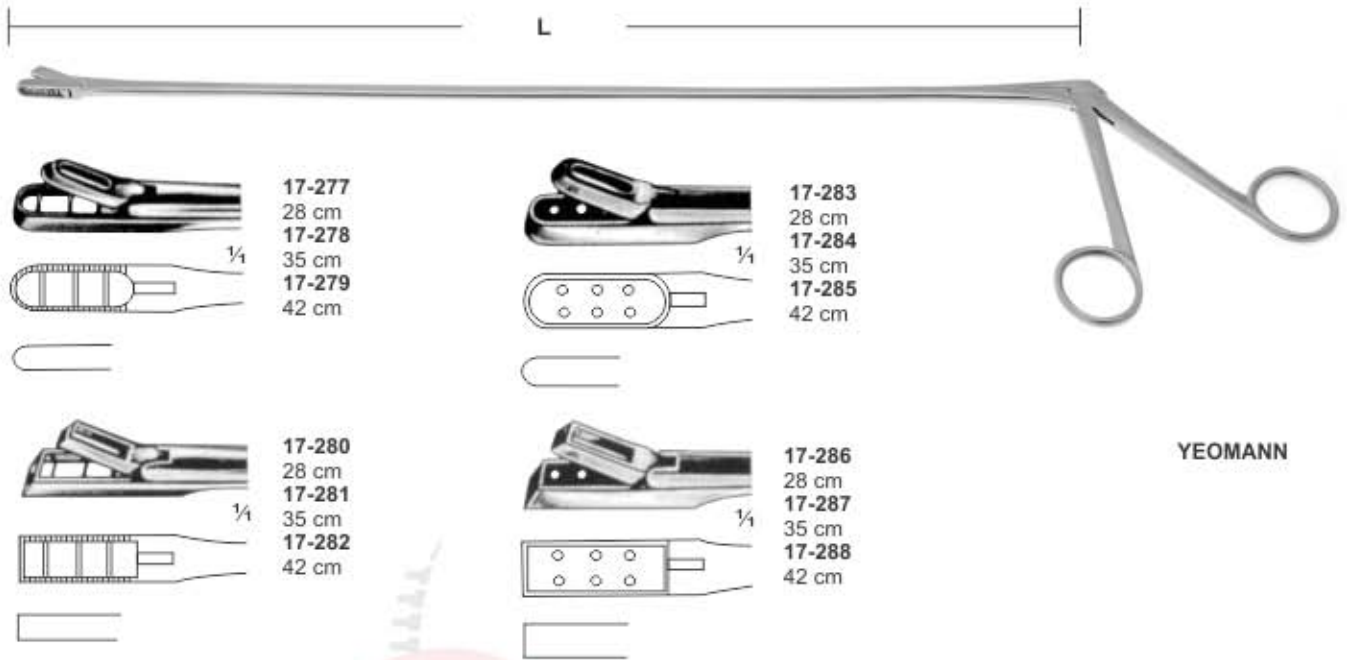

YEOMANN

PILE FORCEPS

MANZIM
SURGICO

COTTON CARRIER



LURE
17-289
24.5cm



JARVIS
17-290
23cm



LANGENBECK
17-291
45cm



17-292
45cm

CERVICAL BIOPSY AND SPECIMEN FORCEPS

Probeexzisionszangen

Pinzas saca-bocados para biopsia

Pinces emporte-pièces à biopsie

Pinze taglianti per biopsia



**Schubert
Biopsy Forceps**
17-293 21 cm
17-294 28 cm

**Faure Uterine
Biopsy Forceps**
17-295 21 cm

**Schubert
Biopsy Forceps**
17-296 26 cm



**Gellhorn
Biopsy Forceps**
17-297 23 cm

**Thoms-Gaylor
Biopsy Forceps**
17-298 22 cm
17-299 24 cm

**Van Doren
Biopsy Forceps**
17-300 24 cm

**Schumacher
Biopsy Forceps**

Fig. 1
17-301
24 cm

Fig. 2
17-302
24 cm

Hakenzangen

Pinces pour l'abaissement du col de l'utérus

Pinzas para coger el cuello del útero

Pinze per abbassare il collo dell'utero



Museux Tenaculum Forceps



24 cm
17-303
8 mm
17-304
6 mm
17-305
10 mm
Straight

24 cm
17-306
8 mm
17-307
6 mm
17-308
10 mm
Curved



Jacobs Uterine Vulsellum Forceps

17-309
21 cm



17-310
21 cm



WINTER
17-311 Fig. 1
17-312 Fig. 2
17-313 Fig. 3
28 cm



Teale Tenaculum Forceps
17-314 23 cm



Pratt Tenaculum Forceps
17-315 26 cm



Czerny Tenaculum Forceps
17-316 20.5 cm



Schroeder Vulsellum Tenaculum Forceps



17-317 24 cm
17-318 24 cm

TENACULUM FORCEPS

Hakenzangen

Pinzas para coger el cuello del útero

Pinces pour l'abaissement du col de l'utérus

Pinze per abbassare il collo dell'utero



Pozzi Tenaculum Forceps
17-319 25.5 cm

Schroeder Tenaculum Forceps
17-320 25 cm

Duplay Tenaculum Forceps
17-321 28 cm

Iowa Tenaculum Forceps
17-322 26 cm

Skene Tenaculum Forceps
17-323 24 cm

MANZIM
SURGICO



Beacham Amniotome
17-324
26 cm

Staude - Moore Tenaculum Forceps
17-325 17 cm

Barrett Tenaculum Forceps
17-326 18 cm

Braun Tenaculum Forceps Sharp
17-327 25 cm

Schroeder-Braun Tenaculum Forceps sharp
17-328 25 cm

17-329
blunt



17-330
20 cm
1 x 2th, Angled
Screw Joint

BONNEY

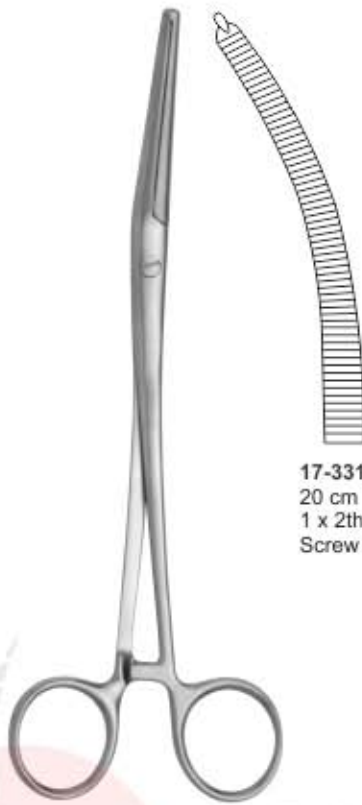

17-331
20 cm
1 x 2th, Curved
Screw Joint

BONNEY-BERKLEY

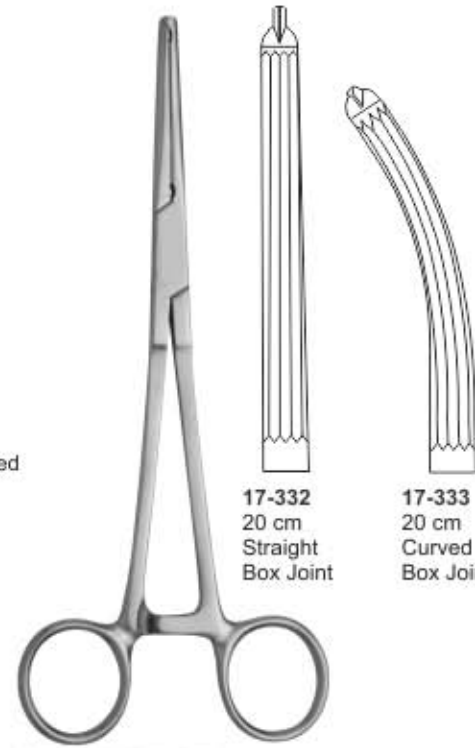

17-332
20 cm
Straight
Box Joint

GWILLIAM



17-333
20 cm
Curved
Box Joint

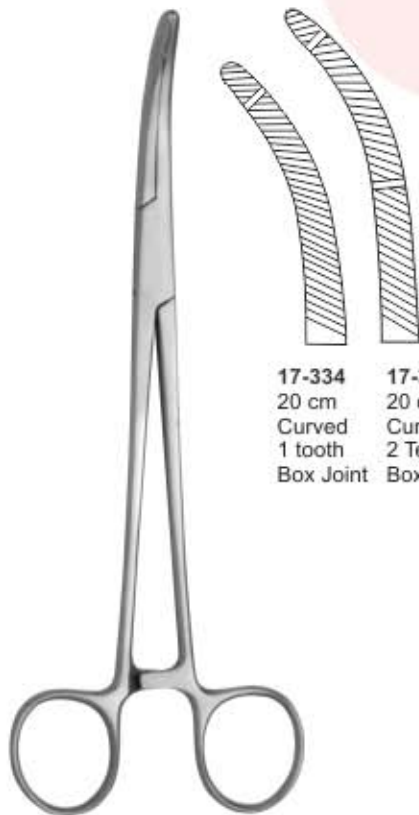

17-334
20 cm
Curved
1 tooth
Box Joint

HEANEY

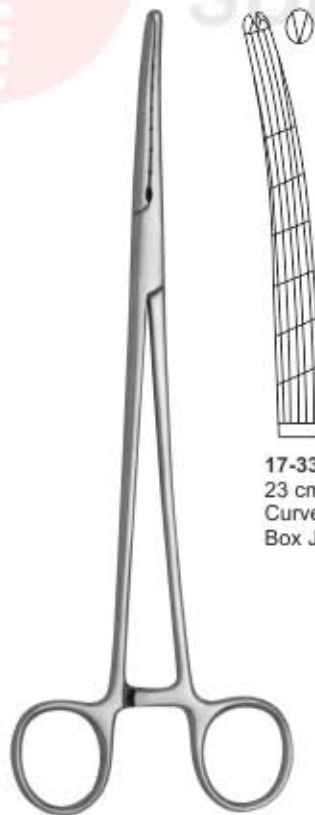

17-335
20 cm
Curved
2 Teeth
Box Joint

HUNTER

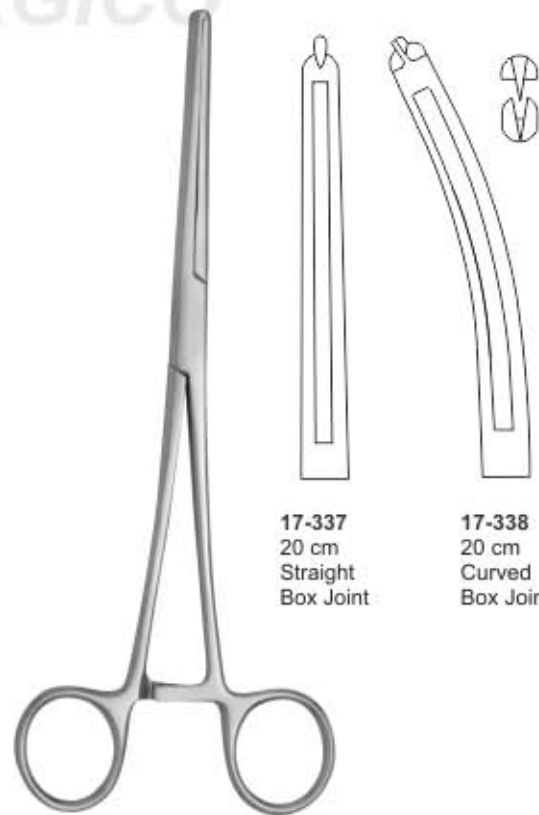

17-336
23 cm
Curved
Box Joint

MAINGOT

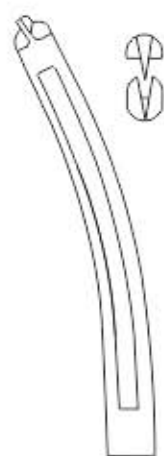

17-337
20 cm
Straight
Box Joint



17-338
20 cm
Curved
Box Joint

Parametriumklemmen, Hysterektomieklemmen
Pinces parametrium, Pinces à hystérectomie

Pinzas parametrium, Pinzas-clamps para histerectomia
Pinze parametrium, Pinze per isterectomia



**Parametrium
Hysterectomy
Forceps**

17-339
21 cm
17-340
24 cm
17-341
30 cm
17-342
35 cm

17-343
21 cm
17-344
24 cm
17-345
30 cm
17-346
35 cm

17-347
21 cm
17-348
24 cm
17-349
30 cm
17-350
35 cm

17-351
21 cm
17-352
24 cm
17-353
30 cm
17-354
35 cm

17-355
21 cm
17-356
24 cm
17-357
30 cm
17-358
35 cm
S-curved



**Rogers Parametrium
Hysterectomy Forceps**

17-359
Fig. 1
22 cm

17-360
Fig. 2
21.5 cm

17-361
Fig. 3
21 cm

17-362
Fig. 4
20.5 cm

17-363
Fig. 1
25 cm

17-364
Fig. 2
25 cm

17-365
Fig. 3
24.5 cm

17-366
Fig. 4
23 cm

MANZIM
SURGICO

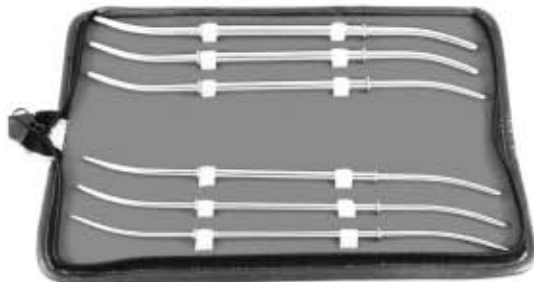

Hank Uterine Dilators 6 Set
17-367 Complete Set
Curved, Delicate, 11-12 Fr. to 21-22 Fr.
(3.66mm to 7.33cm)

Hank Uterine Dilators, Double-ended
17-368 11-12 Fr. (3.6mm x 4.0mm), 27.5cm
17-369 13-14 Fr. (4.3mm x 4.7mm), 27.5cm
17-370 15-16 Fr. (5.0mm x 5.3mm), 27.5cm
17-371 17-18 Fr. (5.7mm x 6.0mm), 27.5cm
17-372 19-20 Fr. (6.3mm x 6.7mm), 27.5cm
17-373 21-22 Fr. (7.0mm x 7.3mm), 27.5cm

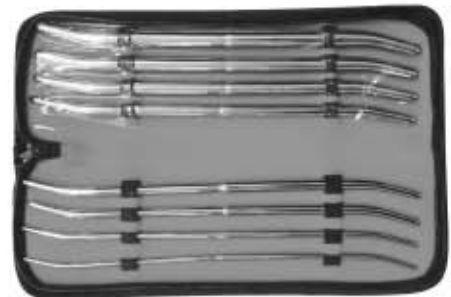

Pratt Uterine Dilators 8/Set
17-374 Complete Set
Curved, Delicate, 13-15 Fr. to 41-43 Fr., Straight

Pratt Uterine Dilators, Double-ended
17-375 13 / 15 Fr., 29.5cm
17-376 17 / 19 Fr., 29.5cm
17-377 21 / 23 Fr., 29.5cm
17-378 25 / 27 Fr., 29.5cm
17-379 29 / 31 Fr., 29.5cm
17-380 33 / 35 Fr., 29.5cm
17-381 37 / 39 Fr., 29.5cm
17-382 41 / 43 Fr., 29.5cm



Hegar uterine dilator
17-383 3 / 4 mm - 17 / 18 mm Ø
8 Pieces per set
17-384 1 / 2 mm - 25 / 26 mm Ø
13 Pieces per set

Hegar uterine dilator
17-385 1 / 2 mm Ø
17-386 3 / 4 mm Ø
17-387 5 / 6 mm Ø
17-388 7 / 8 mm Ø
17-389 9 / 10 mm Ø
17-390 11 / 12 mm Ø
17-391 13 / 14 mm Ø
17-392 15 / 16 mm Ø
17-393 17 / 18 mm Ø
17-394 19 / 20 mm Ø
17-395 21 / 22 mm Ø
17-396 23 / 24 mm Ø
17-397 25 / 26 mm Ø
double ended



Hegar Uterine Dilators 8 Set W/Roll
17-398 Complete Set
Curved, Delicate, 3mm to 18mm, Curved

Hegar Uterine Dilator, Double-ended
17-399 3mm & 4mm, (20cm)
17-400 5mm & 6mm, (20cm)
17-401 7mm & 8mm, (20cm)
17-402 9mm & 10mm, (20cm)
17-403 11mm & 12mm, (20cm)
17-404 13mm & 14mm, (20cm)
17-405 15mm & 16mm, (20cm)
17-406 17mm & 18mm, (20cm)

Uterusdilatoren | Dilataores uterinos
 Dilateurs utérins | Dilatatori uterini

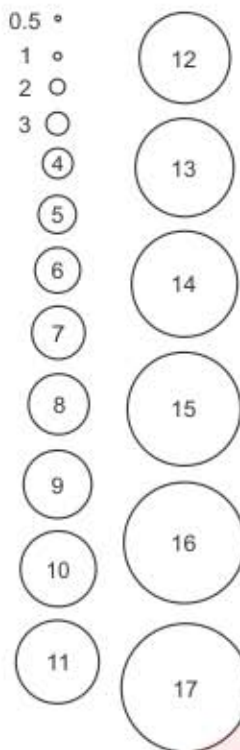

- 17-408 18.5cm 3-4-5mm
 - 17-409 18.5cm 4-5-6mm
 - 17-410 18.5cm 5-6-7mm
 - 17-411 18.5cm 6-7-8mm
 - 17-412 18.5cm 7-8-9mm
 - 17-413 18.5cm 8-9-10mm
 - 17-414 18.5cm 9-10-11mm
 - 17-415 18.5cm 10-11-12mm
 - 17-416 18.5cm 11-12-13mm
 - 17-417 18.5cm 12-13-14mm
 - 17-418 18.5cm 13-14-15mm
 - 17-419 18.5cm 14-15-16mm
 - 17-420 18.5cm 15-16-17mm
 - 17-421 18.5cm 16-17-18mm
 - 17-422 18.5cm 17-18-19mm
 - 17-423 18.5cm 18-19-20mm
- Canvas Roll

Bonney-Barker Dilators
 17-407 Set of 16 Pcs



- 17-425 27cm 9/10mm
- 17-426 27cm 11/12mm
- 17-427 27cm 13/14mm
- 17-428 27cm 15/16mm
- 17-429 27cm 17/18mm
- 17-430 27cm 19/20mm

Hank Double Ended
 17-424 Set of 6 Pcs

MANZIM SURGICO

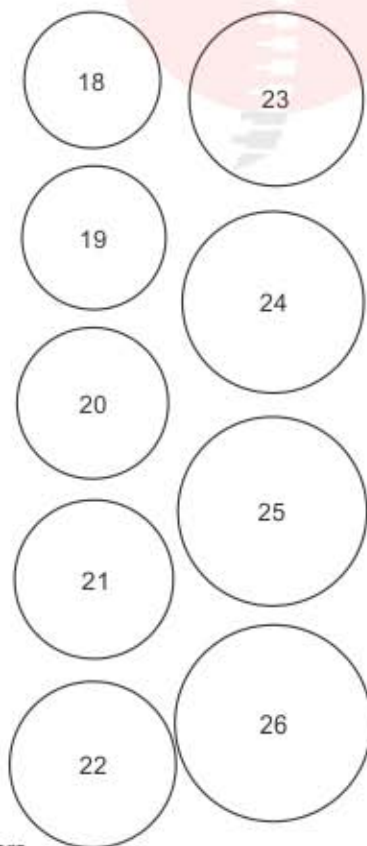

- 17-432 17cm 3-6mm
 - 17-433 17cm 4-7mm
 - 17-434 17cm 5-8mm
 - 17-435 17cm 6-9mm
 - 17-436 17cm 7-10mm
 - 17-437 17cm 8-11mm
 - 17-438 17cm 9-12mm
 - 17-439 17cm 10-13mm
 - 17-440 17cm 11-14mm
 - 17-441 17cm 12-15mm
 - 17-442 17cm 13-16mm
 - 17-443 17cm 14-17mm
 - 17-444 17cm 15-18mm
 - 17-445 17cm 16-19mm
 - 17-446 17cm 17-20mm
 - 17-447 17cm 18-21mm
- Canvas Roll Only

Hawkin Ambler Dilators
 17-431 Set of 16 Pcs



- 20cm 1/2mm
- 20cm 3/4mm
- 20cm 5/6mm
- 20cm 7/8mm
- 20cm 9/10mm
- 20cm 11/12mm
- 20cm 13/14mm
- 20cm 15/16mm
- 20cm 17/18mm
- 20cm 19/20mm
- 20cm 21/22mm
- 20cm 23/24mm
- 20cm 25/26mm
- 17-448 Set 8 Double Ended 3/4mm-17/18mm
- 17-449 Set 12 Double Ended 1/2mm-23/24mm
- 17-450 Set 8 Double Ended Canvas Only
- 17-451 Set 12 Double Ended Canvas Only

Hegar Double Ended Dilators



Hegar
with siped handle

Set	mm	pieces per set
17-452	4-17	14
17-453	1-26	26

17-454	1mm Ø	17-484	1.5mm Ø
17-455	2mm Ø	17-485	2.5mm Ø
17-456	3mm Ø	17-486	3.5mm Ø
17-457	4mm Ø	17-487	4.5mm Ø
17-458	5mm Ø	17-488	5.5mm Ø
17-459	6mm Ø	17-489	6.5mm Ø
17-460	7mm Ø	17-490	7.5mm Ø
17-461	8mm Ø	17-491	8.5mm Ø
17-462	9mm Ø	17-492	9.5mm Ø
17-463	10mm Ø	17-493	10.5mm Ø
17-464	11mm Ø	17-494	11.5mm Ø
17-465	12mm Ø	17-495	12.5mm Ø
17-466	13mm Ø	17-496	13.5mm Ø
17-467	14mm Ø	17-497	14.5mm Ø
17-468	15mm Ø	17-498	15.5mm Ø
17-469	16mm Ø	17-499	16.5mm Ø
17-470	17mm Ø	17-500	17.5mm Ø
17-471	18mm Ø	17-501	18.5mm Ø
17-472	19mm Ø	17-502	19.5mm Ø
17-473	20mm Ø	17-503	20.5mm Ø
17-474	21mm Ø	17-504	21.5mm Ø
17-475	22mm Ø	17-505	22.5mm Ø
17-476	23mm Ø	17-506	23.5mm Ø
17-477	24mm Ø		
17-478	25mm Ø		
17-479	26mm Ø		
17-480	27mm Ø		
17-481	28mm Ø		
17-482	29mm Ø		
17-483	30mm Ø		



Hegar Uterine Dilator
single ended
17-507 4 mm - 17 mm Ø
8 Pieces per set
17-508 1 mm - 26 mm Ø
24 Pieces per set



Hegar Uterine Dilator
single ended
17-509 4 mm - 17 mm Ø
24 pieces per set

Retraktoren und Salpingograph
Écarteurs et salpingographe

Retradores y Salpingografía
Divaricatori e salpingografi



17-510
20cm

GELPI
Vulva Self Retaining



DOYEN
Vaginal Flat Retractor
17-511
1.75mm x 10mm x 23cm



JOLL Thyroid Self Retaining
17-512 15.5cm



Forceps for I.U.D Removing
17-513
4 mm Ø x=230 mm



17-514
IUP Grasping Forceps 3 mm
22 cm



Schultze, Salpingograph
17-515 29.5 cm
complete in wooden case



Catheres Retraktoren & Verbandzangen
Écarteurs et pinces à pansements

Retradores de catéteres y pinzas de apósito
Divaricatori Catheres e pinze per medicazione



17-516 5mm x 25mm
11.5cm
17-517 5mm x 50mm
14cm
17-518 5mm x 80mm
17cm
Cannula

HORMONE
Implant Trocar Set



6EG 4mm
7EG 4.5mm
8EG 5mm
9EG 5.5mm
10EG 6mm

17-519 6EG S/P
17-520 7EG S/P
17-521 8EG S/P
17-522 9EG S/P
17-523 10EG S/P
15.5 cm

FEMALE
Catherers



8EG 5mm
10EG 6mm

17-524 8EG S/P
17-525 10EG S/P
19cm

ROTUNDA
Catherers



6EG 4mm
8EG 5mm
10EG 6mm
12EG 7mm

FEMALE
Bladder Sounds
17-526 6EG S/P
17-527 8EG S/P
17-528 10EG S/P
17-529 12EG S/P
24cm

NEEDLE EXTENSIONS



LEUR
Needle Extensions
17-530 7.5cm
17-531 10cm
17-532 13cm



BOZEMAN
Dressing Forceps
27cm
Box Joint



17-533
Serrated



17-534
Grooved



17-535
Large Bow
Serrated



BONNEY
Vaginal Clamps
17-536
34.5cm
Screw Joint



VAGINAL
Dressing Forceps
17-537
24cm
Serrated



Uterus-Sonden

Histerómetros uterinos

Hystéromètres du col de l'utérus

Isterometri uterini



Sims Uterine Sound
17-538 32 cm
right, graduated in cm
17-539 32 cm
malleable graduated in cm



Sims Uterine Sound
17-540
33 cm
right, malleable



Sims Uterine Sound
17-541
32.5cm
Non-graduated



Sims Uterine Sound
17-542
32.5cm
Graduated in cm



Sims Uterine Sound
17-543
24cm
Graduated in cm



Sims-Special Uterine Sound
17-544
33 cm



Sims Uterine Sound
schwed. Modell
17-545
26 cm



Martin Uterine Sound
17-546 30 cm



Valleix Uterine Sound
17-547 25 cm



Mayo Uterine Sound
17-548 33 cm
biegsam malleable



Simpson Uterine Sound
17-549 29 cm
malleable silver-plated



Simpson Uterine Sound
17-550 32.5cm
Graduated in inches

Wundhäkchen, Wundhaken
Ganchito, Separadores

Crochet, Ecarteurs
Divaricatore, Divaricatori



SMELLIE
17-551
30 cm



Braun, Midwifery
Decapitating hook
17-552
32.5 cm



Suture Retrieval
Hook
17-553
27cm



Suture Retrieval
Hook
Sims Handle
17-554
27 cm



17-555
18cm
Fine
Colour
Coated



IRIS
Skin Hooks



IRIS
Skin Hooks

17-556
25.5cm
Fine
Colour
Coated



TENACULUM EMETT



17-557
23cm
bic



TENACULUM 3 PRONG



17-558
26cm
bic



WHITTAKER



17-559
18.5cm
bic

MANZIM
SURGICO

Myom-Instrumente, Fistelhaken

Instrumentos para fibroma, Ganchos para fistulas

Instruments pour myomes, Crochets pour fistules

Strumenti per miomi, Uncini per fistole



**Second Myoma Knife
Fistula Hook**
17-560
27 cm

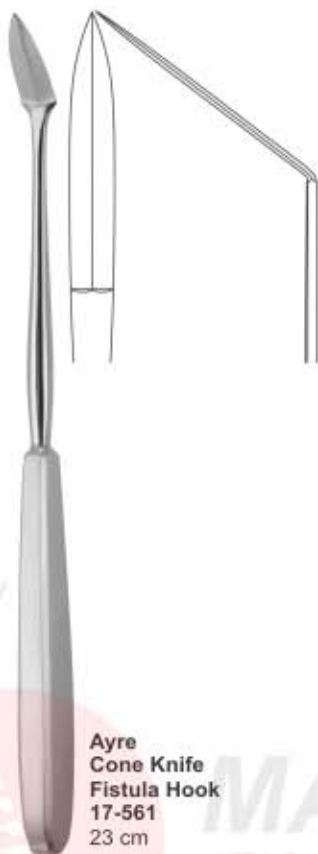

**Ayre Cone Knife
Fistula Hook**
17-561
23 cm



**Doyen Myoma Screw
And Fistula Hook**
17-562 14.5cm
17-563 17 cm



Fig. 1
17-564
22 cm



**Simon
Fistula Hook,
One Prong**



Fig. 2
17-565
22 cm



**Simon
Fistula Hook,
Two Prong**



Fig. 1
17-566
22 cm



**Emmet
Fistula Hook**



Fig. 2
17-567
22 cm



Fig. 3
17-568
22 cm



Fig. 4
17-569
22 cm



Fig. 5
17-570
22 cm



Uni - Randall
aspirating curette
17-571 4 mm Ø
24 cm



Novak
aspirating curette
17-576 4 mm Ø
23 cm

Mini - Novak
aspirating curette
23.5 cm
17-577 1 mm Ø
17-578 2 mm Ø
17-579 3 mm Ø



Uni - Randall
aspirating curette
17-572
30 cm
rigid, without basket

Uni - Randall
aspirating curette
17-573
30 cm
malleable,
without basket



Uni - Randall
aspirating curette
17-574
30 cm
rigid, with basket

Uni - Randall
aspirating curette
17-575
30 cm
malleable,
with basket

MANZIM
SURGICO

**Specimen And
Aspirating Curette**
20 cm
17-580 3 mm Ø
17-581 4 mm Ø
17-582 6 mm Ø
17-583 8 mm Ø
17-584 10 mm Ø
17-585 12 mm Ø
17-586 14 mm Ø







Coupling Piece
aspirating curette
12 cm
17-587

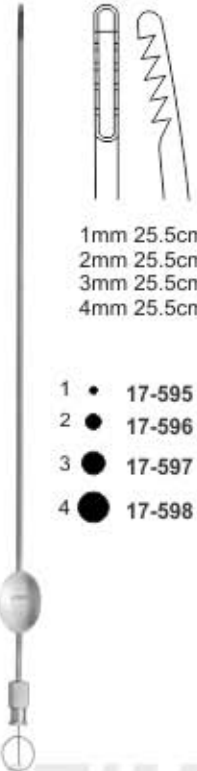
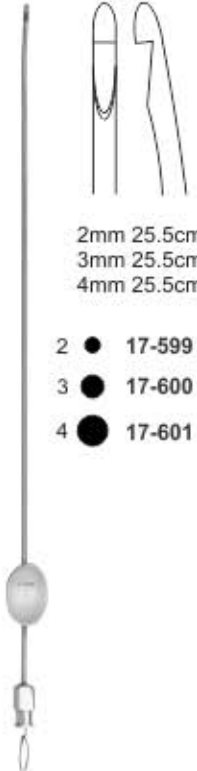

FLUSHING CURETTES

Küretten spülen | Curetas de lavado
Curettes de rinçage | Curette di lavaggio

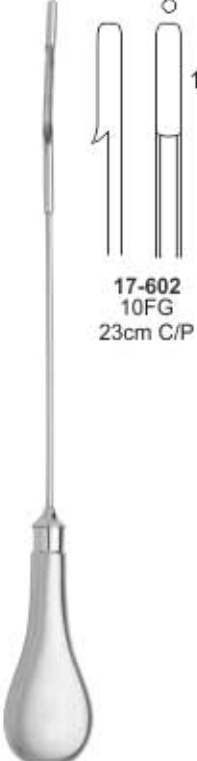
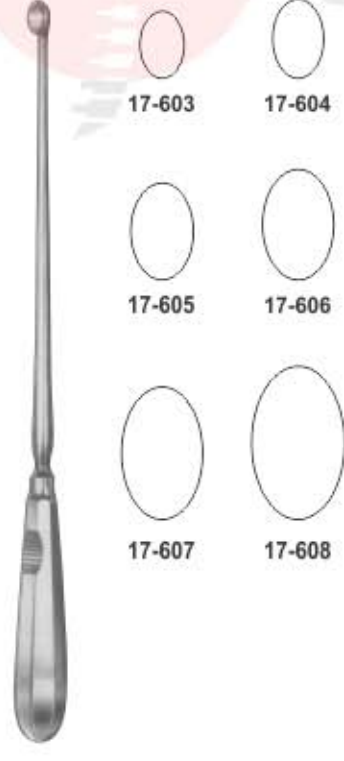
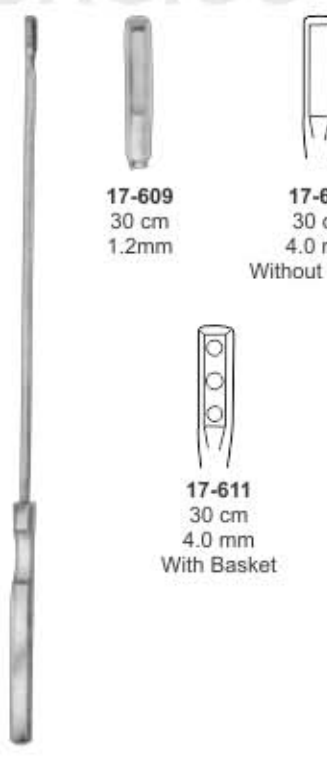
 <p>17-588 Small 29cm 8mm Sharp</p> <p>17-589 Medium 29cm 11mm Sharp</p> <p>17-590 Large 29cm 14mm Sharp</p> <p>Rheinstadter Flushing Curettes</p>	 <p>8.0mm</p> <p>17-591 Small 29cm 8mm Blunt</p> <p>17-592 Medium 29cm 11mm Blunt</p> <p>17-593 Large 29cm 14mm Blunt</p> <p>Rheinstadter Flushing Curettes</p>	 <p>17-594 12 FG 4mm 25.5cm</p> <p>Leechwilkinson Suction Biopsy Curettes</p>	 <p>1mm 25.5cm 2mm 25.5cm 3mm 25.5cm 4mm 25.5cm</p> <p>1 ● 17-595 2 ● 17-596 3 ● 17-597 4 ● 17-598</p> <p>Novak Suction Biopsy Curettes</p>	 <p>2mm 25.5cm 3mm 25.5cm 4mm 25.5cm</p> <p>2 ● 17-599 3 ● 17-600 4 ● 17-601</p> <p>Randall Suction Biopsy Curettes</p>
---	--	--	--	---

 <p>10FG 3.3mm</p> <p>17-602 10FG 23cm C/P</p> <p>Sharman Endometrial Biopsy Curettes</p>	 <p>17-603 17-604</p> <p>17-605 17-606</p> <p>17-607 17-608</p> <p>SCHROEDER 30 cm, 12" sharp, rigid</p>	 <p>17-609 30 cm 1.2mm</p> <p>17-610 30 cm 4.0 mm Without Basket</p> <p>17-611 30 cm 4.0 mm With Basket</p> <p>KEVORKIAN</p>	 <p>17-612 30.5cm</p> <p>Kevorkian Endocervical Curettes With Basket Round</p>
--	--	--	---

Uteruslöffel, Absaugküretten, uterusdepressor

Curettes uterines, curettes d'aspiration, Dépresseur utérin

Cucharillas uterinas, Curetas aspiradoras, depresor uterino

Curette uterine, curette pe aspirazione, depressore uterino



17-613
30.5cm

**Kevorkian
Endocervical
Curettes**
With Basket Square



17-614
30.5cm

**Kevorkian
Endocervical
Curettes**
Without Basket Square



Braun Uterine Depressor
17-615 28 cm



Blake Double Ended
17-616 24.5 cm
Sharp / Blunt



Zweifel Double Ended
17-617 24.5cm
Sharp / Sharp



Coakley
17cm



17-618
Fig. 1



17-619
Fig. 2



17-620
Fig. 3



17-621
Fig. 4



17-622
Fig. 5



17-623
Fig. 6

UTERINE CURETTES

Uterusküretten | Currettes uterinas
Currettes utérines | Curette uterine



**Sims
Single Ended
Sharp**



17-624
Small 6mm
Sharp 25.5cm



17-627
Small 6mm
Blunt 25.5cm



17-625
Medium 9mm
Sharp 25.5cm



17-628
Medium 9mm
Blunt 25.5cm



17-626
Large 12mm
Sharp 25.5cm



17-629
Large 12mm
Blunt 25.5cm



**Sims
Single Ended
S/S**

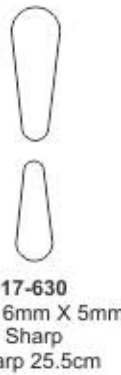

17-630
Small 6mm X 5mm
Sharp
Sharp 25.5cm

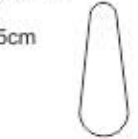

17-631
Medium
9mm X 6mm Sharp
Sharp 25.5cm



17-632
Large
12mm X 9mm Sharp
Sharp 25.5cm



**Blake
17-633
27 cm**

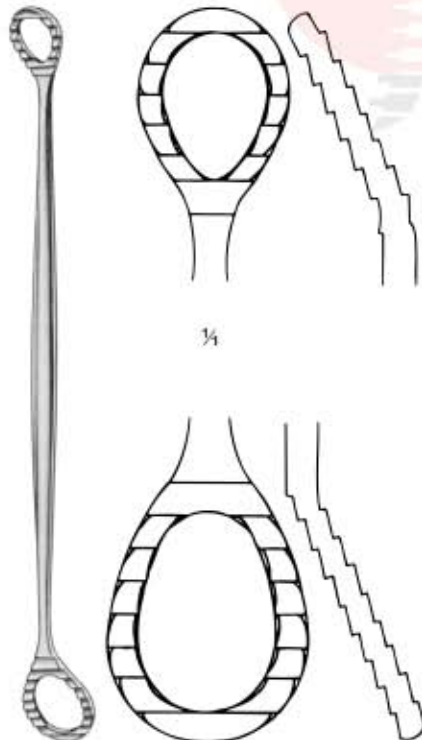

**Sims
17-634
26 cm**



**Sims
Double Ended
B/S**

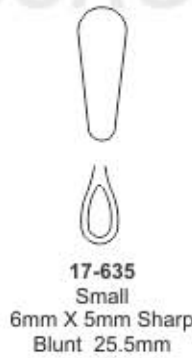

17-635
Small
6mm X 5mm Sharp
Blunt 25.5mm



17-636
Medium
9mm X 6mm Sharp
Blunt 25.5mm

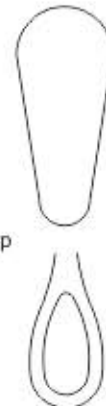

17-637
Large
12mm X 9mm Sharp
Blunt 25.5mm



**Sims
17-638
Double Ended
Sharp Blunt**



Recamier uterine curette y=26 cm	Fig.	x=mm	Sharp, malleable	Blunt, malleable	Sharp, rigid	Blunt, rigid
	00	5	17-639	17-653	17-667	17-681
	0	6	17-640	17-654	17-668	17-682
	1	7	17-641	17-655	17-669	17-683
	2	8	17-642	17-656	17-670	17-684
	3	9	17-643	17-657	17-671	17-685
	4	11	17-644	17-658	17-672	17-686
	5	12	17-645	17-659	17-673	17-687
	6	14	17-646	17-660	17-674	17-688
	7	15	17-647	17-661	17-675	17-689
	8	16	17-648	17-662	17-676	17-690
	9	19	17-649	17-663	17-677	17-691
	10	20	17-650	17-664	17-678	17-692
	11	21	17-651	17-665	17-679	17-693
	12	23	17-652	17-666	17-680	17-694

Recamier uterine curette y=31 cm	Fig.	x=mm	Sharp, malleable	Blunt, malleable	Sharp, rigid	Blunt, rigid
	00	5	17-695	17-709	17-723	17-737
	0	6	17-696	17-710	17-724	17-738
	1	7	17-697	17-711	17-725	17-739
	2	8	17-698	17-712	17-726	17-740
	3	9	17-699	17-713	17-727	17-741
	4	11	17-700	17-714	17-728	17-742
	5	12	17-701	17-715	17-729	17-743
	6	14	17-702	17-716	17-730	17-744
	7	15	17-703	17-717	17-731	17-745
	8	16	17-704	17-718	17-732	17-746
	9	19	17-705	17-719	17-733	17-747
	10	20	17-706	17-720	17-734	17-748
	11	21	17-707	17-721	17-735	17-749
	12	23	17-708	17-722	17-736	17-750

Uterusküretten | Currettes uterinas
Currettes utérines | Curette uterine



Fig. 13



Fig. 14



Fig. 15



Fig. 16

Fig.	x=mm	Sharp, malleable
13	25	17-751
14	30	17-752
15	35	17-753
16	40	17-754

	Blunt, malleable
	17-755
	17-756
	17-757
	17-758

	Sharp, rigid
	17-759
	17-760
	17-761
	17-762

	Blunt, rigid
	17-763
	17-764
	17-765
	17-766

Recamier
uterine curette
y=34 cm



MANZIM
SURGICO



Fig. 1



Fig. 2



Fig. 3



Fig. 4



Fig. 5



Fig. 6

Fig.	x=mm
1	7
2	8
3	9
4	11
5	12
6	14

	Sharp, malleable
	17-767
	17-768
	17-769
	17-770
	17-771
	17-772

	Sharp, rigid
	17-773
	17-774
	17-775
	17-776
	17-777
	17-778

	Blunt, malleable
	17-779
	17-780
	17-781
	17-782
	17-783
	17-784

	Blunt, rigid
	17-785
	17-786
	17-787
	17-788
	17-789
	17-790

Sims
uterine curette
28 cm

UTERINE SPOONS

Scharfe Löffel

Cucharillas cortantes

Curettes tranchantes

Cucchiai tahlienti



Schröder
Uterine Spoon



Fig. 1
17-791
25 cm
Sharp, rigid



Fig. 2
17-792
25 cm
Sharp, rigid



Fig. 3
17-793
25 cm
Sharp, rigid



Fig. 4
17-794
25 cm
Sharp, rigid



Fig. 5
17-795
25 cm
Sharp, rigid



Fig. 6
17-796
25 cm
Sharp, rigid

MANZIM
SURGICO



Schröder
Uterine Spoon



Fig. 1
17-797
30 cm



Fig. 2
17-798
30 cm



Fig. 3
17-799
30 cm



Fig. 4
17-800
30 cm

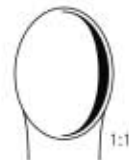
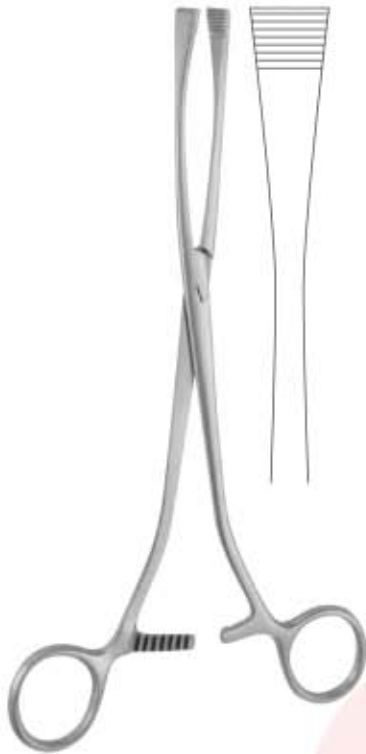

Fig. 5
17-801
30 cm



Fig. 6
17-802
30 cm

Geburtshilfe | obstetrica
obstétrique | Ostetricia



Green-Armytage
Uterine Elevating Forceps
17-803 21 cm



Smellie
Obstetrical Forceps
17-804 25 cm
Perforator



NAEGELE
17-805
25 cm

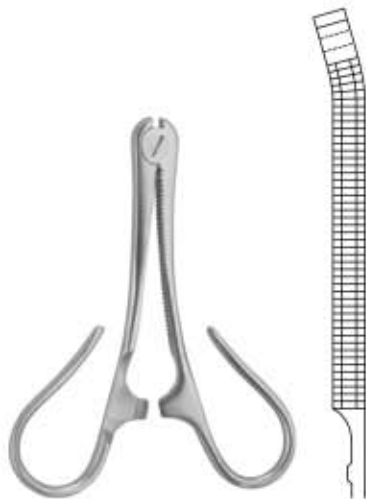

Kane
obstetrical forceps
17-806
8.5 cm



Collin
Obstetrical Forceps
17-807
9 cm



**Zimmerman
Myotome,
Spoon Tip,**
17-808
24 cm



**Zimmerman
Myotome,
Chisel Tip,**
17-809
29 cm

Abortuszangen - Abortusküretten

Pinzas para abort - Curetas para aborto

Pinces à faux germes - Curette d'avortement

Pinze per placenta ed aborto - Curette per placenta ed aborto

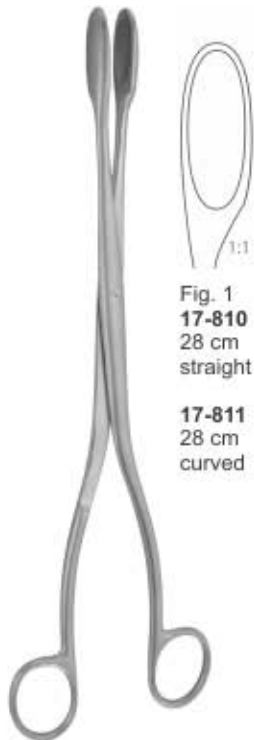

Winter
abortion forceps

Fig. 1
17-810
28 cm
straight

17-811
28 cm
curved



Fig. 2
17-812
28 cm
straight

17-813
28 cm
curved

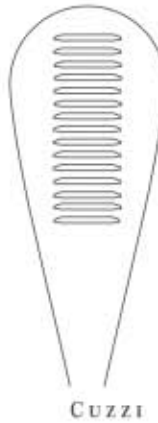

Fig. 3
17-814
28 cm
straight

17-815
28 cm
curved



Cuzzi
ovum curette
blunt, back serrated



C U Z Z I



14.5 mm
17-816
30 cm



18 mm
17-817
30 cm



21 mm
17-818
30 cm



Saenger
Abortion Forceps



17-819
27 cm
Straight



17-820
27 cm
Curved



Wallich
ovum curette
17-821 42 cm



1:1



Pestalozza
Ovum Curette
17-822 30 cm

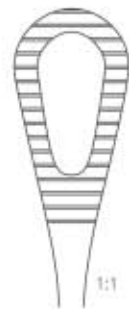

1:1

Beckenzirkel, Geburtszangen

Pelvimetro, Forceps obstétricos

Pelvimètre, Forceps obstétriques

Pelvimetri, Forcipi obstetrici

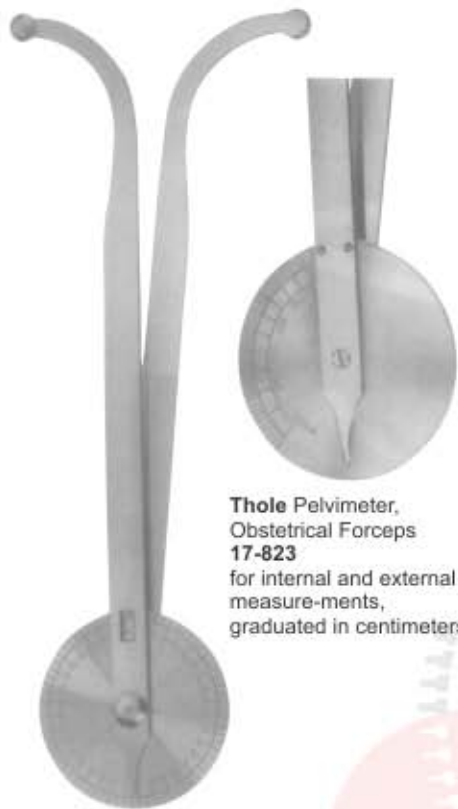

Thole Pelvimeter, Obstetrical Forceps 17-823
for internal and external measurements, graduated in centimeters



De Lee Pelvimeter, Obstetrical Forceps 17-824
graduated in centimeters and inches



Collin Pelvimeter, Obstetrical Forceps 17-825
Graduated in Centimeters



Martin Pelvimeter, Obstetrical Forceps 17-826
graduated in centimeters



Collin Pelvimeter, Obstetrical Forceps 17-827
graduated in centimeters



The additional straight arm can be replaced. The pelvimeter with straight arm is used for localisation of the portio vaginalis uteri and of vaginal metastasis.



Breisky Pelvimeter, Obstetrical Forceps 17-828
graduated in centimeters

Geburtszangen
Forceps obstétricus

Forceps obstétricos
Forcipi



Simpson
Obstetrical Forceps
17-829 23 cm
17-830 30 cm
17-831 33 cm
17-832 36 cm



Simpson - Braun
Obstetrical Forceps
17-833 33 cm
17-834 36 cm



Naegele
Obstetrical Forceps
17-835 36 cm
17-836 40 cm



Piper
obstetrical forceps
17-837 44 cm



Simpson - Luikart
Obstetrical Forceps
17-838 36 cm



Wrigley
Obstetrical Forceps
17-839 25 cm
17-840 28 cm
for caesarian section



De Lee
obstetrical forceps
17-841 30 cm



De Lee
obstetrical forceps
17-842 36 cm
17-843 15 cm



Elliot
obstetrical forceps
17-844 32 cm
17-845 38 cm

OBSTETRICAL FORCEPS

Geburtszangen | Forceps obstétricos
 Forceps obstétriquus | Forcipi



McLean
 obstetrical forceps
 17-846 36 cm



Kielland
 Obstetrical Forceps
 17-847 41 cm



Kielland-Luikart
 obstetrical forceps
 17-848 40 cm

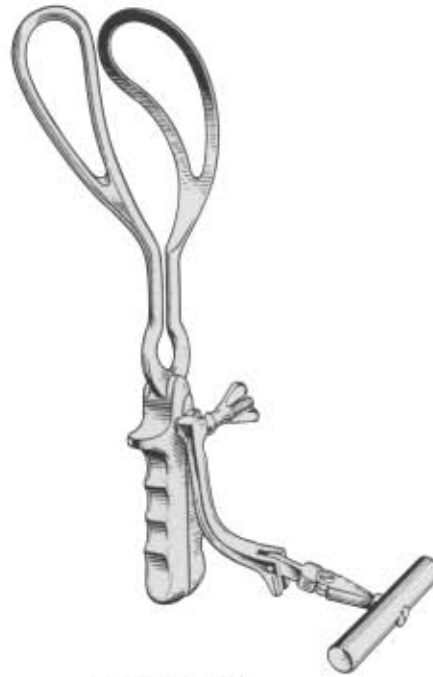

Barnes-Neville
 17-849 40 cm
 Simpson handles, detachable
 axis traction rod and handle.



Bil Obstetrical
 Holder
 17-850



Barnes-Neville
 Obstetrical Forceps
 17-851
 with traction
 handle 43.5 cm



Braun
 obstetrical forceps
 17-852
 42 cm
 Cranioclast, one
 jaw fenestrated



Tarnier
 obstetrical forceps
 17-853
 46 cm
 Basiotribe



Sellheim
 Obstetrical Lever
 17-854
 28 cm

LIPOSUCTION CANNULAS AND SETS



MANZIM
SURGICO



Cannulas for Iniltration | Cánulas de iniltración
 Kanülen zur Iniltration | Canules pour l'iniltration



Cannulas For Iniltration
 Measurements = working length



18-001
 2mmØ
 25cm
 10holes



18-002
 3 mm Ø
 25 cm
 10 holes



Cannulas
18-003
 9 x 70 mm Ø
18-004
 1 x 120 mm Ø

Packing unit 100 pieces, steril



18-005
 Luer-Lock syringes
 Adaptor with Luer-Lock connection, for use of
 cannulas with handle connector on



18-006
 Accessories for Syringes



Ø 1,0 mm

18-007
2 mm Ø
15 cm
18 holes

Entner Cannulas



Ø 1,5 mm

18-008
3 mm Ø
15 cm
18 holes



Ø 1,0 mm

18-009
2 mm Ø
15 cm
18 holes

Entner Cannulas
Measurements = working length



Ø 1,5 mm

18-010
3 mm Ø
15 cm
18 holes

Ø 1,5 mm

Ø 2,0 mm

18-011
3 mm Ø
20 cm
22 holes

18-012
4 mm Ø
20 cm
22 holes

Entner Cannulas
Measurements = working length

Ø 1,5 mm

Ø 2,0 mm

18-013
3 mm Ø
20 cm
22 holes

18-014
4 mm Ø
20 cm
22 holes

Entner Cannulas

LIPOSUCTION CANNULAS

Liposuction Cannulas
Liposuction-Kanülen

Cánulas de liposucción
Canules pour liposuccion

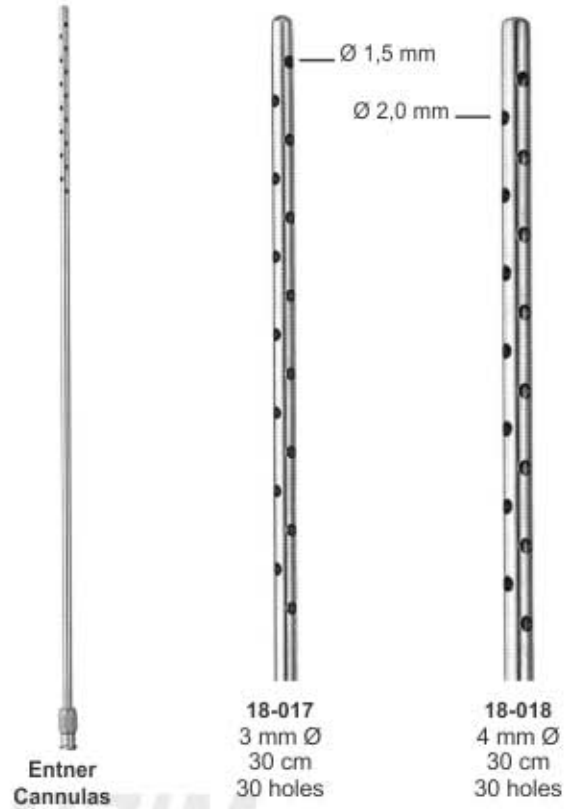
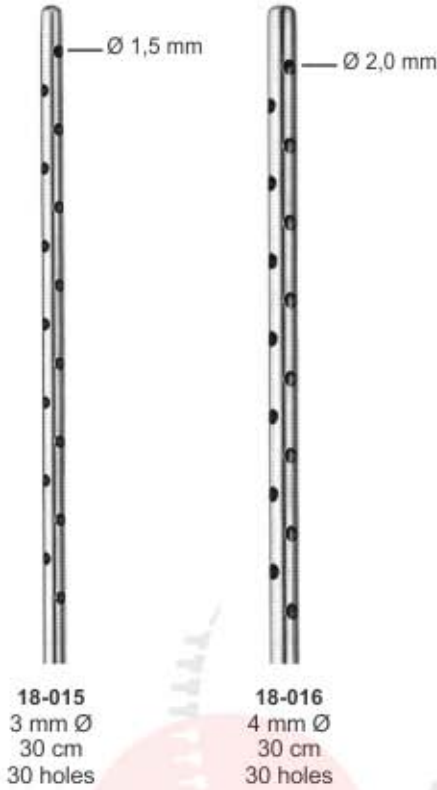

Measurements = working length

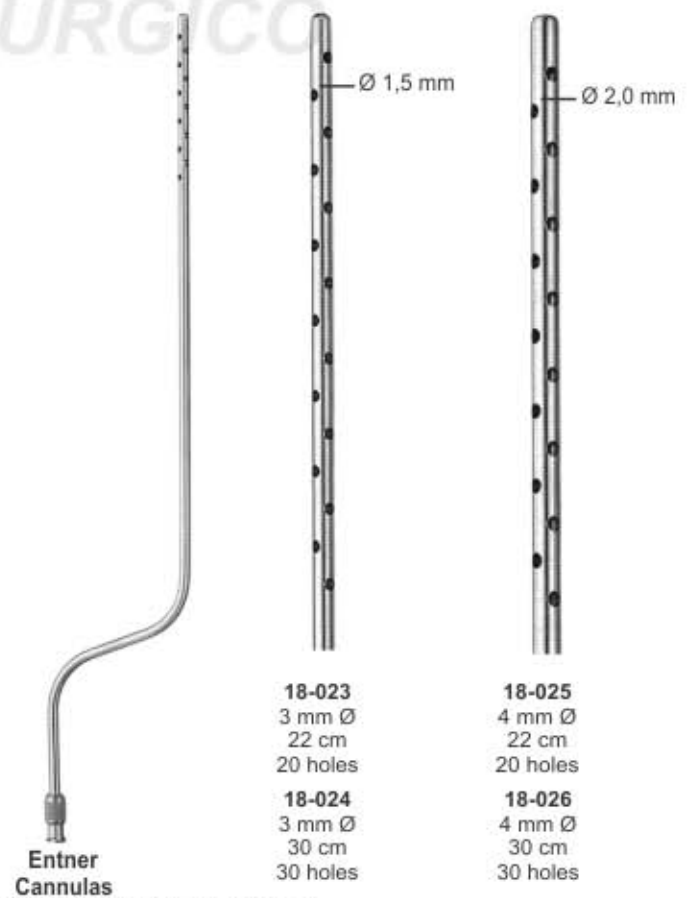
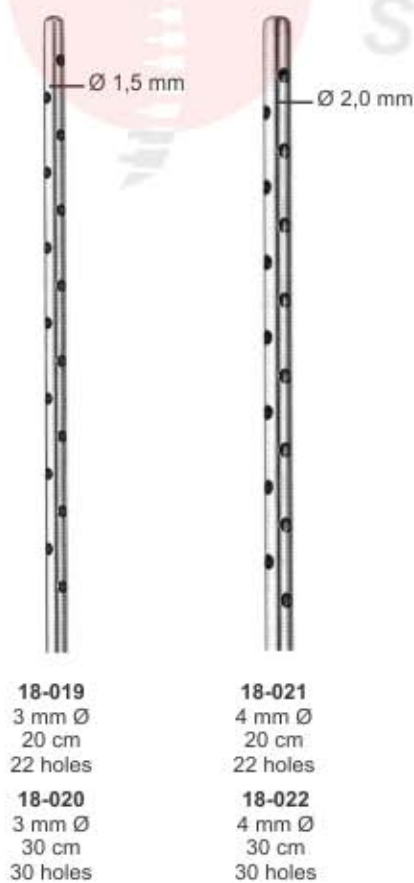

The bayonet shaped handles allow an easier manipulation.



**Entner
Cannulas**

18-027
3 mm Ø
20 cm
22 holes



**Entner
Cannulas**

18-028
3 mm Ø
20 cm
22 holes

Measurements = working length

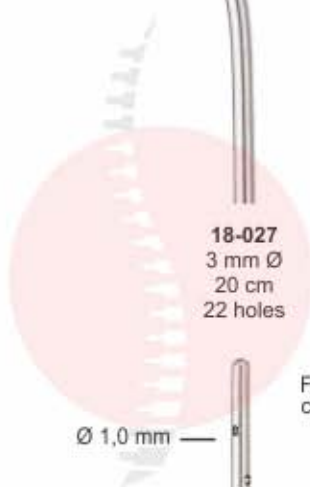

MANZIM
SURGICO

For the facial and neck
contouring.



**Entner
Cannulas**

18-029
2 mm Ø
15 cm
8 holes

Measurements = working length



**Entner
Cannulas**

18-030
2 mm Ø
15 cm
8 holes

Measurements = working length

SET SUGGESTIONS LIPOSUCTION CANNULAS

Set Suggestions Liposuction Cannulas
Setvorschläge Liposuction-Kanülen

Proposiciones de juegos cánulas de liposucción
Propositions pour boîtes canules pour liposuccion



Face Cannulas
18-031
15 cm
2 mm Ø



18-032
5 cm 1,7 mm Ø
18-033
15 cm 1,7 mm Ø



Neck Cannulas
18-034
15 cm
3 mm Ø



Neck Cannulas
18-035
20 cm
3 mm Ø



Neck Cannulas
18-036
15 cm
2 mm Ø



18-037
5 cm 2 mm Ø
18-038
5 cm 3 mm Ø
18-039
15 cm 2 mm Ø
18-040
15 cm 3 mm Ø



MANZIM
SURGICO



Thigh - Lower Leg Cannulas
18-041 20 cm 3 mm Ø
18-042 30 cm 3 mm Ø
18-043 20 cm 4 mm Ø
18-044 30 cm 4 mm Ø



Abdomen / Saddlebag Cannulas
18-045 20 cm 3 mm Ø
18-046 20 cm 4 mm Ø



Abdomen / Saddlebag Cannulas
18-047 30 cm 3 mm Ø
18-048 30 cm 4 mm Ø



18-049
with rotatable tube connection
Accessories

Fork shape, rounded tips, dissecting surface between tips / one central hole.



18-050
2 mm Ø
5 cm

18-051
2 mm Ø
15 cm



18-052
3 mm Ø
5 cm

18-053
3 mm Ø
15 cm

18-054
3 mm Ø
25 cm

18-055
3 mm Ø
30 cm



18-056
4 mm Ø
5 cm

18-057
4 mm Ø
25 cm

18-058
4 mm Ø
30 cm



18-059
5 mm Ø
30 cm

Toledo Cannulas
Measurements = working length

MANZIM
SURGICO



18-060
3 mm Ø
15 cm

18-061
3 mm Ø
25 cm

three lateral holes

Mercedes Cannulas
Measurements = working length



18-062
4 mm Ø
15 cm

18-063
4 mm Ø
25 cm

Kotzur Cannulas



Turbo

18-064
3 mm Ø
30 cm

The improved arrangement of the suction holes ensures a more effective and gentle suction in areas with much connective tissue and in case of gynecomasty.

Liposuction Cannulas
Liposuction-Kanülen

Cánulas de liposucción
Canules pour liposuction



Cannulas



one central hole, two lateral holes
Measurements = working length



18-065
3 mm Ø
20 cm



18-067
4 mm Ø
30 cm



18-068
5 mm Ø
30 cm



18-069
6 mm Ø
30 cm

18-066
3 mm Ø
30 cm



Cannulas



two lateral holes,
one central hole



18-070
3 mm Ø
20 cm



18-072
4 mm Ø
30 cm



18-073
5 mm Ø
30 cm



18-074
6 mm Ø
30 cm

18-071
3 mm Ø
30 cm

Measurements = working length

MANZIM
SURGICO

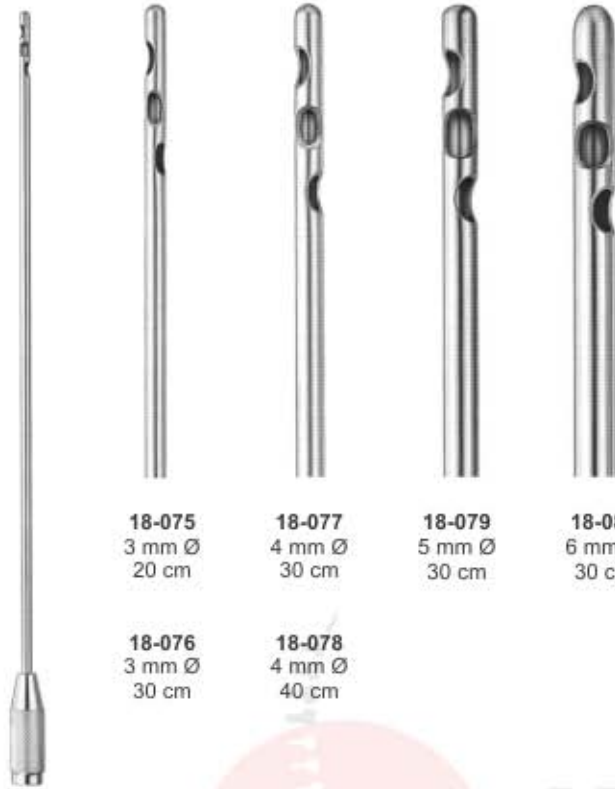

18-075
3 mm Ø
20 cm

18-077
4 mm Ø
30 cm

18-079
5 mm Ø
30 cm

18-080
6 mm Ø
30 cm

18-076
3 mm Ø
30 cm

18-078
4 mm Ø
40 cm

Cannulas
three holes, diagonal
Measurements = working length

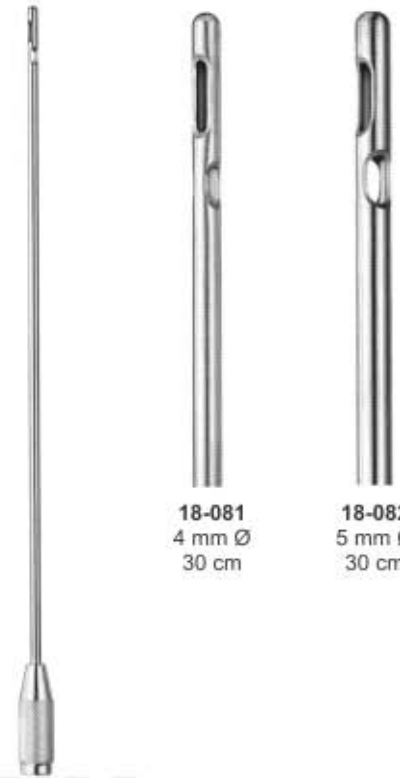

18-081
4 mm Ø
30 cm

18-082
5 mm Ø
30 cm

Cannulas
one central hole, two lateral holes
Measurements = working length



18-083
3 mm Ø
20 cm

18-084
3 mm Ø
30 cm

Cannulas
Point with hole, one lateral hole

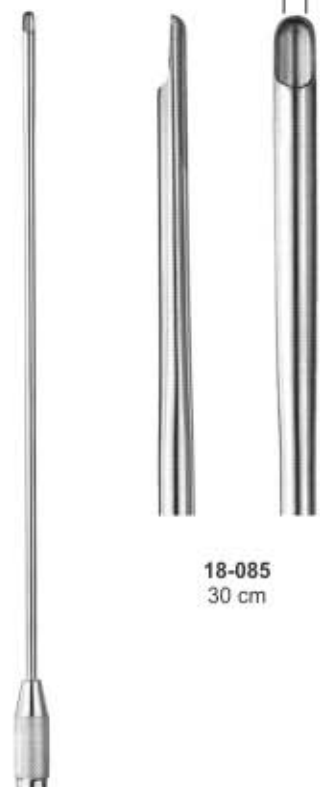

18-085
30 cm

Cannulas
Measurements = working length

Liposuction Cannulas
Liposuction-Kanülen

Cánulas de liposucción
Canules pour liposuction

For facial contouring,
one lateral hole



Cannulas
with handle connector



18-086
1,7 mm Ø
5 cm



18-088
2 mm Ø
5 cm



18-090
3 mm Ø
5 cm



Cannulas
with Luer-Lock connection
Measurements = working length

18-092
1,7 mm Ø
5 cm

18-093
1,7 mm Ø
15 cm

18-094
2 mm Ø
5 cm

18-095
2 mm Ø
15 cm

18-096
3 mm Ø
5 cm

18-097
3 mm Ø
15 cm

18-087
1,7 mm Ø
15 cm

18-089
2 mm Ø
15 cm

18-091
3 mm Ø
15 cm

Handles with connection thread for cannulas and hose connection 0 13 mm, for operation with a suction pump.

Recommended handles for the tumescence local anaesthesia technique
Hole for interrupting the suction process



18-098
Fix Handle



18-099
with rotatable tube connection
Handle



18-100
Fix Handle



18-101
with rotatable tube connection
Handle



Liposuction cannulas, stainless steel with thumb plate and hose connection Ø 13 mm, for use with a suction pump.



18-102
3 mm Ø
15 cm
one central hole



18-103
4 mm Ø
25 cm
one central hole



18-104
6 mm Ø
15 cm
one central hole



18-105
6 mm Ø
25 cm
one central hole



18-106
9 mm Ø
30 cm
one central hole

Gasparotti Cannulas
Measurements = working length



18-107
4 mm Ø
15 cm
two central holes



18-108
4 mm Ø
25 cm
two central holes



18-109
6 mm Ø
30 cm
two central holes

Gasparotti Cannulas
Measurements = working length



18-110
3 mm Ø
15 cm
one central hole



18-111
6 mm Ø
15 cm
one central hole



18-112
6 mm Ø
25 cm
one central hole

Gasparotti Cannulas Measurements = working length

Liposuction Cannulas
Liposuction-Kanülen

Cánulas de liposucción
Canules pour liposuccion

Liposuction Cannulas Set



18-113
Liposuction Cannula Set for Abdomen and Saddlebag With Threaded Fitting
Liposuction Cannula with threaded connector, 22-Holes, diameter 3.0 mm, working length 20cm
Liposuction Cannula with threaded connector, 22-Holes, diameter 4.0 mm, working length 20cm
Liposuction Cannula with threaded connector, 30-Holes, diameter 3.0 mm, working length 30cm
Liposuction Cannula with threaded connector, 30-Holes, diameter 4.0 mm, working length 30cm
Liposuction Cannula Handle
Liposuction Cannula Handle with Interrupting Hole



18-114
Liposuction Cannula Set for Face with Luer Lock Fitting
Liposuction Cannula, with one central hole, diameter 1.7 mm, working length 5 cm
Liposuction Cannula, with one central hole, diameter 1.7 mm, working length 15 cm
Liposuction Cannula, 18-Holes, diameter 2.0 mm, working length 15 cm



18-115
Liposuction Cannula Set for Face with Threaded Fitting
Liposuction Cannula, with one central hole, diameter 1.7 mm, working length 5 cm
Liposuction Cannula, with one central hole, diameter 1.7 mm, working length 15 cm
Liposuction Cannula, 18-Holes, diameter 2.0 mm, working length 15 cm
Liposuction Cannula Handle
Liposuction Cannula Handle with Interrupting Hole

18-116
Liposuction Cannula Set for Neck
Liposuction Cannula with Luer-Lock, with one central hole, diameter 2.0 mm, working length 5cm
Liposuction Cannula with Luer-Lock, with one central hole, diameter 3.0 mm, working length 5cm
Liposuction Cannula with Luer-Lock, with one central hole, diameter 2.0 mm, working length 15cm
Liposuction Cannula with Luer-Lock, with one central hole, diameter 3.0 mm, working length 15cm
Liposuction Cannula with threaded connector, 18-Holes, diameter 3.0 mm, working length 15 cm
Liposuction Cannula with threaded connector, Angled, 22-Holes, diameter 3.0 mm, working length 20 cm
Liposuction Cannula with threaded connector, 8-Holes, diameter 2.0 mm, working length 15 cm
Liposuction Cannula Handle
Liposuction Cannula Handle with Interrupting Hole

Liposuction Cannulas Set

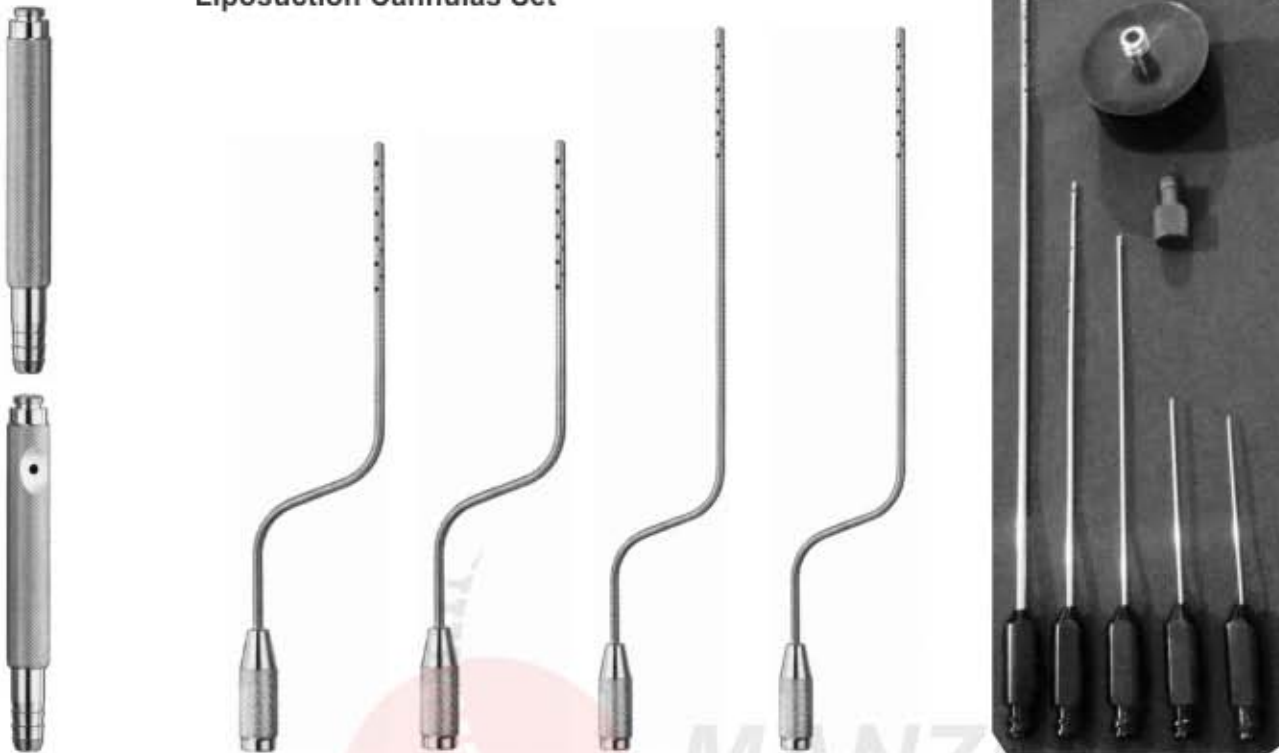

18-117

- Liposuction Cannula Set for Thie and Lower Leg with Threaded Fitting
- Liposuction Cannula with threaded connector, byonet shape, 22-Holes, diameter 3.0 mm, working length 20 cm
- Liposuction Cannula with threaded connector, byonet shape, 22-Holes, diameter 4.0 mm, working length 20 cm
- Liposuction Cannula with threaded connector, byonet shape, 30-Holes, diameter 3.0 mm, working length 30 cm
- Liposuction Cannula with threaded connector, byonet shape, 30-Holes, diameter 4.0 mm, working length 30 cm
- Liposuction Cannula Handle
- Liposuction Cannula Handle with Interrupting Hole

18-118

- Micro Fat Injection Cannulas Set
- Open Port Injector Cannula, 1.2mm, 10cm, Luer Lock
- Multi Holes Harvester Cannula Model 2, 2.5mm, 20cm, Luer Lock
- Tumescent Infiltrator Cannula, 1.5mm, 12cm Luer Lock
- Micro Injector Cannula, 0.8mm, 4cm, Luer Lock
- Micro Injector Cannula, 1.0mm, 5cm, Luer Lock
- Holding Device
- Luer Lock Syringe Cap

Safe Cannula Set

18-119

- 1 TWO STANDARD HOLE LIPOSUCTION CANNULA, 3.5mm, 25cm, Super Handle
- 2 Mercedes Liposuction Cannula, 5.0mm, 30cm, Super Handle
- 3 Mercedes Liposuction Cannula, 4.5mm, 30cm, Super Handle
- 4 Mercedes Liposuction Cannula, 4.0mm, 25cm, Super Handle
- 5 Single Basket Liposuction Cannulas, 4.0mm, 30cm, Super Handle
- 6 Double Basket Liposuction Cannulas, 4.0mm, 30cm, Super Handle
- 7 Triple Basket Liposuction Cannulas, 4.0mm, 30cm, Super Handle
- 8 Spiral Three Port Harvester Cannula, 3.0mm, 20cm, Super Handle
- 9 Spiral Three Port Harvester Cannula, 4.0mm, 25cm, Super Handle
- 10 Three Port Harvester Cannula, Model 4, 4.5mm, 30cm, Super Handle
- 11 Three Ports Pyramid Cannula, 3.5mm, 25cm, Super Handle
- 12 Basket Cannula, 5.0mm, 32cm, Super Handle



Fat Injection Syringes

Fat Suction Syringes

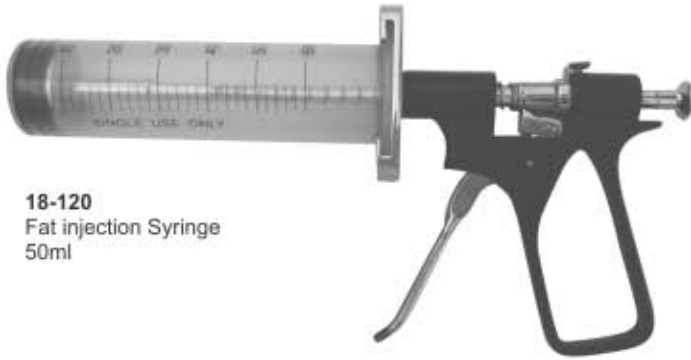

18-120
Fat injection Syringe
50ml



18-125
Fat Suction Syringe
50 ml



18-121
Universal Fat Injection syringe
20ml



18-126
Fat Suction Syringe
50 ml



18-122
Universal Fat Injection syringe
10ml

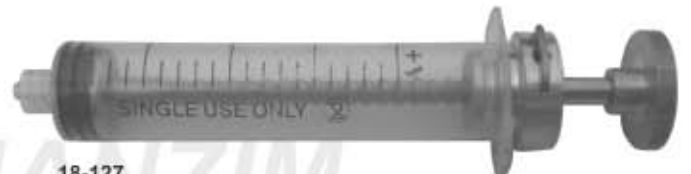

18-127
Fat Suction Syringe
20 ml



18-123
Fat Injection Syringes
0.1 ml per click
1 ml



18-128
Fat Suction Syringe
10 ml



18-124
Fat Injection Syringe
3 ml special
0.1 ml per click



18-129
Fat Suction Syringe
5 ml



18-130
Fat Suction Syringe
3 ml

HOLLOW WARES



Sterilisieren Schlagzeug
Tambores de esterilización

Tambours de stérilisation
Tamburi di sterilizzazione



	Ø	h
	mm	mm
19-001	80	80
19-002	120	120
19-003	160	120
19-004	190	140
19-005	190	200
19-006	240	120
19-007	240	160
19-008	240	240
19-009	290	120
19-010	290	160
19-011	290	240
19-012	340	160
19-013	340	240
19-014	390	145
19-015	390	200
19-016	390	290

STERILIZING DRUMS

MANZIM SURGICO



STERILIZING DRUM

	Ø	h
	mm	Size mm
19-017	150	150
19-018	175	175
19-019	190	190
19-020	200	140
19-021	200	200
19-022	240	120
19-023	225	225
19-024	240	240
19-025	290	160
19-026	280	240
19-027	230	150
19-028	300	250
19-029	340	250
19-030	350	250
19-031	390	200

STERILIZING DRUM

	Ø	h
	mm	Size mm
19-032	150	150
19-033	175	175
19-034	190	190
19-035	200	140
19-036	200	200
19-037	240	120
19-038	225	225
19-039	240	240
19-040	290	160
19-041	280	240
19-042	230	150
19-043	300	250
19-044	340	250
19-045	350	250
19-046	390	200

STERILIZING DRUM

	Ø	h
	mm	Size mm
19-047	150	150
19-048	175	175
19-049	190	190
19-050	200	140
19-051	200	200
19-052	240	120
19-053	225	225
19-054	240	240
19-055	290	160
19-056	280	240
19-057	230	150
19-058	300	250
19-059	340	250
19-060	350	250
19-061	390	200

STERILIZING DRUM

	Ø	h
	mm	Size mm
19-062	150	150
19-063	175	175
19-064	190	190
19-065	200	140
19-066	200	200
19-067	240	120
19-068	225	225
19-069	240	240
19-070	290	160
19-071	280	240
19-072	230	150
19-073	300	250
19-074	340	250
19-075	350	250
19-076	390	200



G LOVES BOX
19-077
300 x 150 mm



INSTRUMENT TRAY WITH COVER
19-078



INSTRUMENT TRAY
19-079



CATHER TRAY

	Size
19-080	230 x 75 mm
19-081	350 x 90 mm
19-082	430 x 100 mm
19-083	200 x 100 mm
19-084	300 x 100 mm
19-085	350 x 100 mm

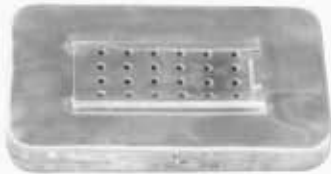

PERFORATED BOX

	Size
19-086	100 x 50 mm
19-087	165 x 65 mm
19-088	250 x 100 mm
19-089	250 x 150 mm
19-090	250 x 200 mm
19-091	150 x 65 mm
19-092	170 x 70 mm
19-093	200 x 100 mm
19-094	250 x 125 mm
19-095	300 x 150 mm
19-096	300 x 200 mm
19-097	300 x 130 mm
19-098	320 x 150 mm
19-099	420 x 180 mm
19-100	460 x 125 mm
19-101	355 x 180 mm
19-102	300 x 180 mm
19-103	400 x 200 mm
19-104	510 x 200 mm

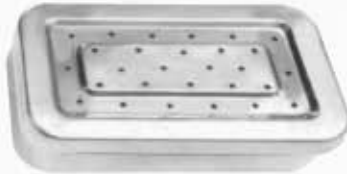

BOX WITH FILTER

	Size
19-105	100 x 50 mm
19-106	165 x 65 mm
19-107	250 x 100 mm
19-108	250 x 150 mm
19-109	250 x 200 mm
19-110	150 x 65 mm
19-111	170 x 70 mm
19-112	200 x 100 mm
19-113	250 x 125 mm
19-114	300 x 150 mm
19-115	300 x 200 mm
19-116	300 x 130 mm
19-117	320 x 150 mm
19-118	420 x 180 mm
19-119	460 x 125 mm
19-120	355 x 180 mm
19-121	300 x 180 mm
19-122	400 x 200 mm
19-123	510 x 200 mm



INSTRUMENTS BOX

Without Clip	Size
19-124	100 x 50 mm
19-125	165 x 65 mm
19-126	250 x 100 mm
19-127	250 x 150 mm
19-128	250 x 200 mm
19-129	150 x 65 mm
19-130	170 x 70 mm
19-131	200 x 100 mm
19-132	250 x 125 mm
19-133	300 x 150 mm
19-134	300 x 200 mm
19-135	300 x 130 mm
19-136	320 x 150 mm
19-137	420 x 180 mm
19-138	460 x 125 mm
19-139	355 x 180 mm
19-140	300 x 180 mm
19-141	400 x 200 mm
19-142	510 x 200 mm



INSTRUMENT BOX

With Clip	Size
19-143	100 x 50 mm
19-144	165 x 65 mm
19-145	250 x 100 mm
19-146	250 x 150 mm
19-147	250 x 200 mm
19-148	150 x 65 mm
19-149	170 x 70 mm
19-150	200 x 100 mm
19-151	250 x 125 mm
19-152	300 x 150 mm
19-153	300 x 200 mm
19-154	300 x 130 mm
19-155	320 x 150 mm
19-156	420 x 180 mm
19-157	460 x 125 mm
19-158	355 x 180 mm
19-159	300 x 180 mm
19-160	400 x 200 mm
19-161	510 x 200 mm



INSTRUMENT BOILER

	Size
19-162	180 x 80 x 40 mm
19-163	200 x 100 x 50 mm
19-164	250 x 125 x 40 mm
19-165	300 x 150 x 60 mm
19-166	350 x 175 x 75 mm
19-167	400 x 200 x 100 mm



PERFORATED TRAY

	Size
19-168	180 x 80 x 40 mm
19-169	200 x 100 x 50 mm
19-170	250 x 125 x 40 mm
19-171	300 x 150 x 60 mm
19-172	350 x 175 x 75 mm
19-173	400 x 200 x 100 mm

Hohlware Instrumenten
Orfebreria Instrumentos

orfèurerie de Instruments de
Holloware Gli strumenti



INSTRUMENT BOILER ELECTRIC

	Size
19-174	180 x 80 x 40 mm
19-175	200 x 100 x 50 mm
19-176	250 x 125 x 40 mm
19-177	300 x 150 x 60 mm
19-178	350 x 175 x 75 mm
19-179	400 x 200 x 100 mm



INSTRUMENT BOILER WITH STAND

	Size
19-180	180 x 80 x 40 mm
19-181	200 x 100 x 50 mm
19-182	250 x 125 x 40 mm
19-183	300 x 150 x 60 mm
19-184	350 x 175 x 75 mm
19-185	400 x 200 x 100 mm



NEEDLE CASE
19-186
230 x 125 mm

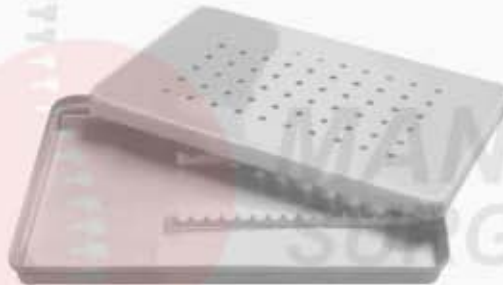

SCALER BOX
19-187
300 x 180 mm



SCALER TRAY
19-188
100 x 200 mm



INDO BOX WITH SILVER FRAME
19-189



Autoclaveable
19-190



INSTRUMENT TRAY WITHOUT COVER

	Size		Size
19-191	240 x 240 mm	19-202	230 x 125 mm
19-192	355 x 400 mm	19-203	200 x 150 mm
19-193	300 x 150 mm	19-204	250 x 200 mm
19-194	300 x 180 mm	19-205	300 x 250 mm
19-195	300 x 240 mm	19-206	350 x 300 mm
19-196	340 x 320 mm	19-207	400 x 350 mm
19-197	230 x 180 mm	19-208	450 x 300 mm
19-198	250 x 130 mm	19-209	300 x 200 mm
19-199	200 x 130 mm	19-210	350 x 250 mm
19-200	180 x 130 mm	19-211	250 x 125 mm
19-201	150 x 100 mm	19-212	200 x 100 mm
		19-213	400 x 200 mm



INSTRUMENT TRAY WITHOUT COVER

	Size		Size
19-214	240 x 240 mm	19-225	230 x 125 mm
19-215	355 x 400 mm	19-226	200 x 150 mm
19-216	300 x 150 mm	19-227	250 x 200 mm
19-217	300 x 180 mm	19-228	300 x 250 mm
19-218	300 x 240 mm	19-229	350 x 300 mm
19-219	340 x 320 mm	19-230	400 x 350 mm
19-220	230 x 180 mm	19-231	450 x 300 mm
19-221	250 x 130 mm	19-232	300 x 200 mm
19-222	200 x 130 mm	19-233	350 x 250 mm
19-223	180 x 130 mm	19-234	250 x 125 mm
19-224	150 x 100 mm	19-235	200 x 100 mm
		19-236	400 x 200 mm



KIDNEY TRAY WITH COVER
(English Pattern)

	Size
19-237	150 mm
19-238	200 mm
19-239	240 mm
19-240	300 mm



KIDNEY TRAY (German Pattern)
(without cover)

	Size
19-241	150 mm
19-242	200 mm
19-243	240 mm
19-244	300 mm



SPLIT LAMP
19-245
100 ml.



BOWL

	Size
19-246	80 mm
19-247	100 mm
19-248	125 mm
19-249	150 mm
19-250	200 mm
19-251	250 mm
19-252	300 mm
19-253	350 mm
19-254	400 mm



WASH BASIN

	Size
19-255	80 mm
19-256	100 mm
19-257	125 mm
19-258	150 mm
19-259	200 mm
19-260	250 mm
19-261	300 mm
19-262	350 mm
19-263	400 mm



BOWL

	Size
19-264	80 mm
19-265	100 mm
19-266	125 mm
19-267	150 mm
19-268	200 mm
19-269	250 mm
19-270	300 mm
19-271	350 mm
19-272	400 mm



DRESSING JAR WITH KNOB

	Size
19-273	80 x 80 mm
19-274	100 x 100 mm
19-275	125 x 125 mm
19-276	150 x 150 mm
19-277	200 x 200 mm



DRESSING JAR

	Size
19-278	80 x 80 mm
19-279	100 x 100 mm
19-280	125 x 125 mm
19-281	150 x 150 mm
19-282	200 x 200 mm



DRESSING JAR

	Size
19-283	80 x 80 mm
19-284	100 x 100 mm
19-285	125 x 125 mm
19-286	150 x 150 mm
19-287	200 x 200 mm



DRESSING JAR

	Size
19-288	80 x 80 mm
19-289	100 x 100 mm
19-290	125 x 125 mm
19-291	150 x 150 mm
19-292	200 x 200 mm

Hohlware Instrumenten
Orfebreria Instrumentos

orfènerie de Instruments de
Holloware Gli strumenti



**FORCEPS
JAR**

	Size
19-293	55 x 100 mm
19-294	55 x 140 mm
19-295	55 x 170 mm
19-296	55 x 180 mm
19-297	80 x 100 mm



**FORCEPS
JAR**

	Size
19-298	55 x 100 mm
19-299	55 x 140 mm
19-300	55 x 170 mm
19-301	55 x 180 mm
19-302	80 x 100 mm



**FORCEPS
JAR**

	Size
19-303	55 x 100 mm
19-304	55 x 140 mm
19-305	55 x 170 mm
19-306	55 x 180 mm
19-307	80 x 100 mm



**FORCEPS
JAR**

	Size
19-308	55 x 100 mm
19-309	55 x 140 mm
19-310	55 x 170 mm
19-311	55 x 180 mm
19-312	80 x 100 mm



**FORCEPS
JAR**

	Size
19-313	55 x 100 mm
19-314	55 x 140 mm
19-315	55 x 170 mm
19-316	55 x 180 mm
19-317	80 x 100 mm



**COTTON HOLDER
19-318**



GALIPOTS

	Capacity
19-319	2 Ounces
19-320	3 Ounces
19-321	4 Ounces
19-322	5 Ounces
19-323	6 Ounces
19-324	7 Ounces
19-325	8 Ounces



GALIPOTS

	Capacity
19-326	2 Ounces
19-327	3 Ounces
19-328	4 Ounces
19-329	5 Ounces
19-330	6 Ounces
19-331	7 Ounces
19-332	8 Ounces



**SPRIT LAMP
19-333
100 ml.**



**INDO BOX ROUND
19-334**



**NEEDLE CASE
19-335**



MEASURING JUG

	Capacity
19-336	1.00 Ltr
19-337	1.50 Ltr
19-338	2.00 Ltr



MEDICINE CUP GRADUATED

	Capacity
19-339	50 ml
19-340	60 ml
19-341	100 ml



BUCKET WITH LID

	Capacity
19-342	10 Ltr
19-343	12 Ltr
19-344	15 Ltr



SPUTUM MUG
19-345
100 x 50 mm



ENEMA CANE
Capacity
19-346 0.5 Ltr
19-347 1.5 Ltr
19-348 2.0 Ltr



DUST BIN
19-349
20 Lit



ROUND BEDPAN
19-350
300 x 85 mm



BEDPAN
19-351
Size: Adult, Child



BEDPAN
19-352
Size: Adult, Child



FUNNAL
19-353
100 mm



URINAL - FEMALE
19-354



URINAL - MALE
19-355



SHAVING MUG
19-356
100 mm

INSTRUMENTS MANAGEMENT SYSTEM

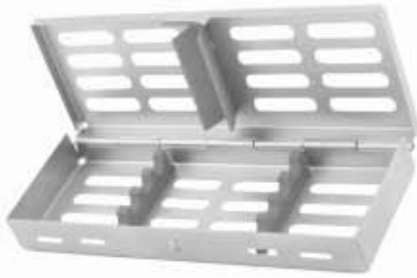

**Cassette For 4 Instruments
19-357**



**Cassette For 5 Instruments
19-358**



**Cassette For 6 Instruments
19-359**



**Cassette For 7 Instruments
19-360**



**Cassette For 10 Instruments
19-361**



**Cassette For 20 Instruments
19-362**

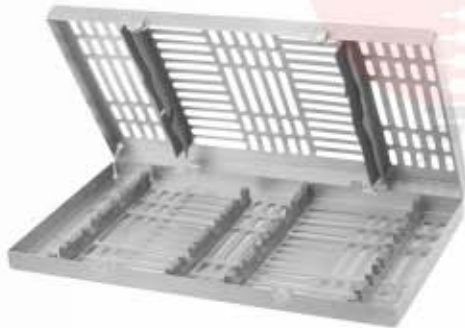

**Cassette For Extraction Forceps
19-363**



**Cassette For Root Elevator
19-364**



**19-365
Cassette Tray
15 Pcs**



**19-366
Cassette Tray
15 Pcs**



**Instruments Cassette
19-367 5 Pieces Cassette
19-368 7 Pieces Cassette
19-369 10 Pieces Cassette**



**19-370
18×11×3.5cm
Extra large cassette for 6
Instruments, with compartment
for small parts hinged lids**

STERILIZING MESH TRAY

Different sizes & dimensions are available at buyer's demand



MESH TRAYS
19-371
Different sizes & dimensions are available at buyer's demand

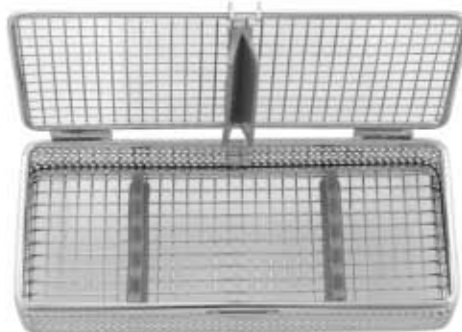

MESH TRAYS
19-372
05 Pcs



MESH TRAYS
19-373
07 Pcs

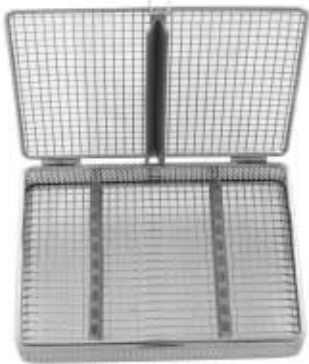

MESH TRAYS
19-374
10 Pcs



MESH TRAYS
19-375
20 Pcs

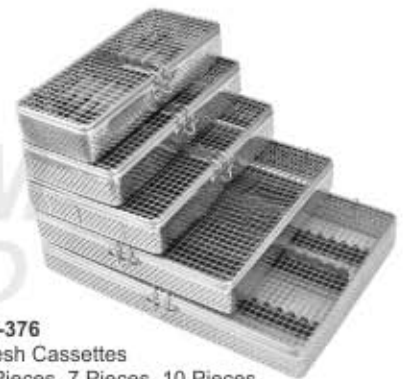

19-376
Mesh Cassettes
5 Pieces, 7 Pieces, 10 Pieces,
15 Pieces & 20 Pieces



MESH TRAY
19-377 240x130x50mm
19-378 240x130x60mm
19-379 240x250x50mm
19-380 240x250x60mm
19-381 480x250x50mm
19-382 480x250x60mm
19-383 480x250x70mm



MESH TRAY
19-384 240x250x 50mm
19-385 240x250x 60mm
19-386 240x250x 70mm
19-387 480x250x 50mm
19-388 480x250x 60mm
19-389 480x250x 70mm
19-390 480x250x100mm



MESH TRAY
19-391 240x250x50mm
19-392 240x250x60mm
19-393 240x250x70mm
19-394 280x250x50mm
19-395 280x250x60mm



MESH TRAY
19-396 280x250x 70mm
19-397 280x250x100mm
19-398 280x250x 50mm
19-399 280x280x 60mm
19-400 280x280x 70mm
19-401 300x280x 60mm

perforiert Körbe
Cestas perforadas

paniers perforés
ceste forate

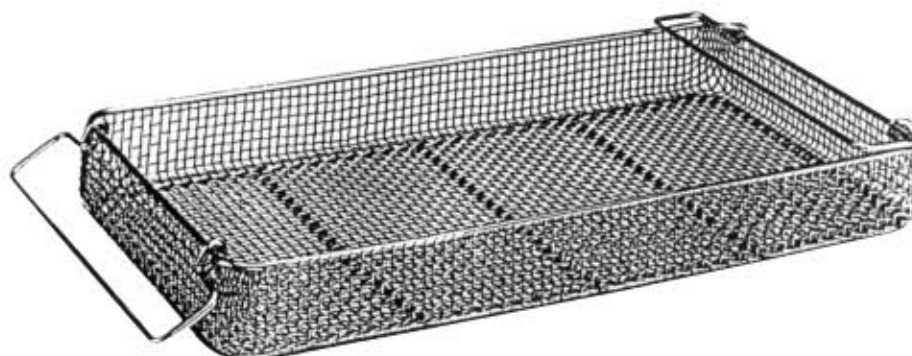
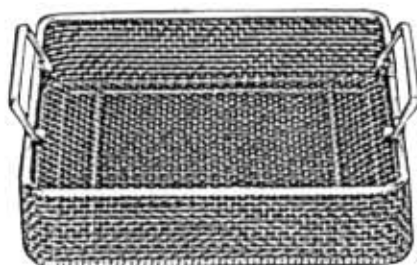

MESH BASKET

- 19-402 240 x 258 x 50 mm
- 19-403 250 x 240 x 100 mm
- 19-404 240 x 250 x 60mm

MESH BASKET

- 19-405 480 x 258 x 50 mm
- 19-406 480 x 258 x 100 mm
- 19-407 520 x 258 x 60mm
- 19-408 520 x 258 x 70mm
- 19-409 450 x 340 x 70mm
- 19-410 320 x 230 x 70mm

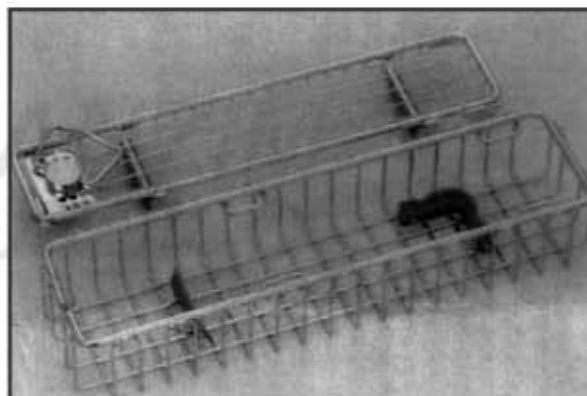

MESH BASKET

With Perforated Sheet Side

- 19-411 230 x 130 x 50 mm
- 19-412 230 x 130 x 60 mm
- 19-413 240 x 130 x 50 mm
- 19-414 240 x 130 x 60 mm
- 19-415 240 x 250 x 50 mm
- 19-416 240 x 250 x 60 mm
- 19-417 480 x 250 x 50 mm
- 19-418 480 x 250 x 60 mm
- 19-419 480 x 250 x 70 mm
- 19-420 300 x 300 x 50 mm
- 19-421 350 x 350 x 60 mm
- 19-422 470 x 400 x 60 mm
- 19-423 480 x 480 x 50 mm
- 19-424 480 x 480 x 60 mm
- 19-425 500 x 300 x 50 mm
- 19-426 520 x 300 x 50 mm
- 19-427 520 x 300 x 60 mm
- 19-428 550 x 430 x 50 mm
- 19-429 600 x 300 x 60 mm

ARTHROSCOPE BASKET

- 19-430 290 x 80 x 52 mm

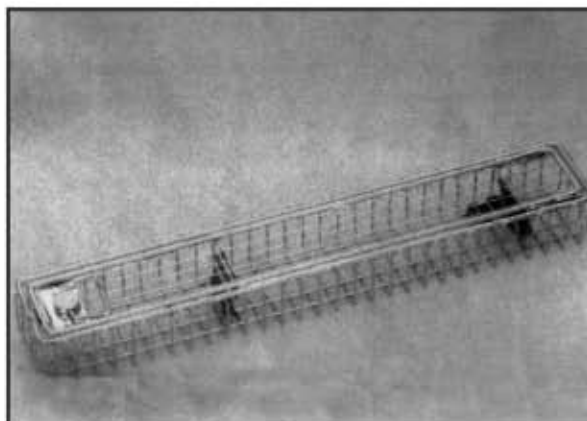

ENDOSCOPE BASKET

- 19-431 460 x 80 x 52 mm
- 19-432 660 x 80 x 52 mm
- 19-433 670 x 80 x 52 mm

Sterilisieren Zange
Pinzas de esterilización

Pinces stérilisation
Pinze di sterilizzazione



DAVIS
19-434 16 cm, 6 1/4"
19-435 20 cm, 8"
19-436 24 cm, 9 1/2"



UTILITY
19-437 20 cm, 8"
19-438 28 cm, 11"

MANZIM
SURGICO



19-439 20 cm, 8"
19-440 25 cm, 10"
19-441 30 cm, 11 3/4"



ROGGE
19-442
27 cm, 11"



CHEATEL
Box Joint
19-443
27 cm, 11"



CHEATEL
Screw Joint
19-444
27 cm, 11"

DESCRIPTION	PAGE#
A	
ABADIE STOMACH INTESTINAL TWIN CLAMP FORCEPS	346
ABDOMEN / SADDLEBAG CANNULAS	413
ABDOMINAL RETRACTORS	160-161
ABORTION FORCEPS - OVUM CURETTES	405
ABRAHAM TONSIL KNIFE	31-309
ABRE BOCA MC IVOR C/3 LAMINAS S/ SUCCAO RETRACTORS	159
ABRE BOCA RETRACTORS	159
ACCESSORIES FOR SYRINGES	409
ADLERKREUTZ DRESSING FORCEPS	65
ADLERKREUTZ TISSUE FORCEPS	62
ADSON BAYONET DRESSING FORCEPS	67
ADSON BROWN	71
ADSON BROWN TISSUE	71
ADSON DRILL GUIDE	238
ADSON ELEVATOR	201
ADSON FORCEPS	69
ADSON HAEMOSTATIC FINE POINT FORCEPS	82
ADSON HAEMOSTATIC TISSUE FORCEPS	82
ADSON NEEDLE HOLDERS	103
ADSON NERVE DURA HOOK	243
ADSON RETRACTOR	156
ADSON SUCTION TUBES	17
ADSON TISSUE & DRESSING FORCEPS	70-71
ADSON TISSUE & DRESSING FORCEPS T.C	77
ADSON TISSUE FORCEPS	71
ADSON TISSUE FORCEPS T.C	77
ADSON-BROWN TISSUE & DRESSING FORCEPS	70
ADSON-BROWN TISSUE FORCEPS T.C	77
AESCULAP SPONGE & DRESSING FORCEPS	98
AGRIS DINGMAN BREAST DISSECTOR, SET OF 2	162
AIACH FORCEPS	170
ALAN-PARKS SPECULUM	350
ALDERDYCE ELEVATORS	200
ALEXANDER BIOPSY AND SPECIMEN FORCEPS	380
ALEXANDER CHISEL	185
ALEXANDER GOUGE	185
ALEXANDER PERIOSTEAL ELEVATOR	202
ALLEN INTESTINAL CLAMP	341
ALLIGATOR FORCEPS	334
ALLIS TISSUE FORCEPS	338
ALLIS TISSUE GRASPING FORCEPS	339
ALLIS-ADAIR INTESTINAL AND TISSUE GRASPING FORCEPS	339
ALLISON LUNG SPATULA RETRACTOR	278
ALM RETRACTOR	151
AMPUTATING & RESECTION SAWS	182
AMPUTATION KNIFE	30
ANAESTHOSIS STETHOSCOPE	91
ANASTOMOSIS CLAMPS, LIGATURE FORCEPS	268
ANDERSON BEAR CLAW RETRACTOR	177
ANDERSON-ADSON RETRACTOR	156
ANDERSON-NIEVERT OSTEOTOME	187
ANDREWS-PYNCHON SUCTION TUBE	17
ANEURYSM CLAMPS	271
ANGLED BLADE PLATE	234
ANTRUM CURETTES	310
APPLYING FORCEPS FOR BULLDOG CLAMPS	264
APPLYING FORCEPS MINI	241
APPLYING FORCEPS STANDARD	241
ARCUS MARGINALIS DISSECTOR	164
AREOLA MARKERS, BREAST DISSECTORS AND ELEVATOR	162
ARRUGA NEEDLE HOLDERS	110
ARRUGA NEEDLE HOLDERS T.C	119
ARTERY SCISSORS	48
ARTHROSCOPE BASKET	433
ASH SEPTUM FORCEPS	322
ATRAUMA MICRO BULLDOG CLAMPS	264
AUFRICHT NASAL RETRACTORS WITH FIBER OPTIC	176
AUFRICHT NASAL RETRACTOR	171-172
AUFRICHT NASAL SAW	314
AUFRICHT RETRACTOR SPECULUM	323
AUFRICHT WALTER NASAL RETRACTOR	171
AUTOCLAVEABLE	427
AUTOPSY KNIFE	31
AUVARD SPECULUM & RETRACTOR	377
AUVARD SPECULUM	378
AUVARD STEINER SPECULUM	378
AYRE CONE KNIFE	31-396
B	
BABCOCK INTESTINAL & TISSUE GRASPING CLAMP FORCEPS T.C	342
BABCOCK SEIZING FORCEPS	340
BABCOCK TISSUE GRASPING FORCEPS	340
BABINSKY HAMMER	92
BABY ALLIS TISSUE FORCEPS	338
BABY CRILE-WOOD NEEDLE HOLDER	101
BABY CRILE-WOOD NEEDLE HOLDERS T.C	115
BABY METZENBAUM SUPER CUT SCISSORS	55
BABY YANKAUER SUCTION TUBE	17
BABY-DOYEN INTESTINAL FORCEPS CLAMPS	343
BABY-KOCHER INTESTINAL FORCEPS CLAMPS	342
BABY-MIKULICZ HAEMOSTATIC TISSUE FORCEPS	90
BABY-ROUX RETRACTOR	140
BACKHAUS CLIP TOWEL FORCEPS	93
BACKHAUS TOWEL FORCEPS	93
BAILEY-BABY RIB CONTRACTORS	277

DESCRIPTION	PAGE#
BAILEY-GIBBON RIB CONTRACTORS	277
BAILEY-GIGLI SAW	238
BAINBRIDGE INTESTINAL FORCEPS CLAMPS	344
BAINBRIDGE PERIPHERAL VASCULAR CLAMPS	270
BAKES COMMON BILE DUCT DILATORS, MALLEABLE	361
BALFOUR RETRACTOR	158
BALFOUR-BABY RETRACTOR	158
BALL & SOCKET TOWEL FORCEPS	93
BALLENGER KNIFE	316
BALLENGER-HAJEK PERIOSTEAL SEPTUM ELEVATORS	312
BANDAGE SCISSORS	52
BANE BONE RONGEUR	213
BARANY NOISE DRUM	299
BARNES-NEVILLE OBSTETRICAL FORCEPS	408
BARNES-NEVILLE SIMPSON	408
BARNHILL ADENOID CURETTE	315
BARON SUCTION TUBES	18
BARR CRYPT HOOK	22
BARR FISTULA PROBE	22
BARR RECTAL SPECULUM	350
BARRAQUER SOLID BLADE WIRE SPECULUM	294
BARRAQUER WIRE SPECULUMS	294
BARRAQUER CILIA FORCEPS	74
BARRAQUER MICRO NEEDLE HOLDER T.C	120
BARRAQUER MICRO NEEDLE HOLDERS	109
BARRAQUER NEEDLE HOLDERS	109,287-289
BARRAQUER SCISSORS	49
BARRAQUER-TROUTMAN NEEDLE HOLDERS	110
BARREN MCGIVNEY HEMORRHOIDAL LIGATOR FORCEPS	354
BARRETT TENACULUM FORCEPS	386
BARR-SHILFORD INTESTINAL RECTAL SPECULUM	351
BAUER RETRACTOR WITH FIBER OPTIC	176
BAUMGARTNER NEEDLE HOLDER	101
BAUMGARTNER NEEDLE HOLDERS T.C	112
BAYONET MICRO KERRISON LAMINECTOMY RONGEURS	252
BAYONET SPURLING KERRISON LAMINECTOMY RONGEURS	252
BEACHAM AMNIOTOME	386
BEAVER SCALPEL HANDLE	25
BECKMAN ADENOID CURETTE	315
BECKMAN RETRACTOR	157
BECKMANN ADENOID CURETTE	315
BECKMANN NASAL SPECULUM	305
BECKMAN-WEITLANER RETRACTOR	156
BEDPAN	430
BEEBEE WIRE CUTTING SCISSORS	46
BEER CILIA FORCEPS	74
BENDING DEVICE	232
BENGOLEA HAEMOSTATIC FORCEPS	85
BENGOLEA HAEMOSTATIC TISSUE FORCEPS	85
BENNET RETRACTOR	145
BENSAUDE INTESTINAL RECTAL SPECULUM	351
BERGER CERVICAL BIOPSY AND SPECIMEN FORCEPS	380
BERGMANN MALLETS	191
BERGMANN SCISSORS	51
BERKE PTOSIS FORCEPS	286
BERLINER HAMMER	92
BERNHARD TOWEL FORCEPS	94
BERTILLON MEASURING DEVICE	13
BEVER HANDLE	26
BEYER BONE EAR RONGEURS	321
BEYER BONE RONGEUR	213
BIGGS MAMMAPLASTY RETRACTOR	167
BIL OBSTETRICAL HOLDER	408
BILLEAU EAR LOOP	308
BIMANUAL HAND ASPIRATION	292
BIMANUAL HAND IRRIGATION	292
BIOLVAR PROBES	23
BIOPSY AND SPECIMEN FORCEPS	380
BIOPSY AND SPECIMEN FORCEPS HANDLE ONLY	382
BIOPSY CURETTES	398
BIOPSY CURETTES, ASPIRATING CURETTES	397
BIRCH TROCAR	15
BIRCHER MENISCOTOMY KNIFE	205
BIRCHER-GANSKE BONE HOLDING FORCEPS	225
BISHOP BONE CLAMP	223
BLACK LINE' KERRISON LAMINECTOMY PUNCH	261
BLADDER NECK SPREADER, BLADDER RETRACTORS	364-365-366
BLADE HOLDER BLADE BREAKER & HOLDER, WITH RATCHET LOCK	26
BLAKE DOUBLE ENDED	399
BLAKE GALL STONE FORCEPS	358
BLAKE UTERINE CURETTES	400
BLALOCK RIB CONTRACTORS	277
BLOHMKE TONSIL FORCEPS	329
BLOOD SCOOP	150
BLOUNT KNEE RETRACTOR	139
BLOUNT RETRACTOR	208
BLUMENTHAL BONE RONGEUR	212
BOHLER BONE CUTTING RONGEUR FORCEPS	217
BOHLER BONE RONGEUR	213
BOHLER KIRSCHNER EXTENSION BOWS	233
BOIES NASAL FRACTURE ELEVATOR,	312
BONE CHISELS & GOUGES	185-186-187-188-189
BONE CURETTES	195-196-197-198-199
BONE CUTTING FORCEPS	217-218
BONE CUTTING RONGEUR FORCEPS	217
BONE FILES	183
BONE HOLDING CLAMPS - BONE HOLDING FORCEPS	221
BONE HOLDING FORCEPS - REPOSITION FORCEPS	222

DESCRIPTION	PAGE#
BONE HOLDING FORCEPS	223-224-225-226-227
BONE LEVERS	207-208
BONE MILL, WITH ASSEMBLING WRENCH	170
BONE REDUCTION FORCEPS	222-223-224-225-226-227
BONE REDUCTION ORTHOPEDIC FORCEPS	222
BONE RIB SHEAR	283
BONE RONGEURS	212-213-214-215-216
BONE TAMPS	194
BONN FORCEPS	285
BONNEY DISSECTING & TISSUE FORCEPS T.C	78
BONNEY TISSUE FORCEPS	64
BONNEY UTERUS HOLDING FORCEPS	387
BONNEY VAGINAL CLAMPS	393
BONNEY-BARKER DILATORS	390
BONNEY-BERKLEY UTERUS HOLDING FORCEPS	387
BOOK WALTER RETRACTOR	262
BOUCHERON EAR SPECULUM	295
BOWL	428
BOWLBY PAEDIATRIC TRACHEAL DILATOR	331
BOWLBY TROUSSEAU TRACHEAL DILATOR	331
BOWMAN LACRIMAL PROBES DOUBLE ENDED, STERLING SILVER	22
BOWMAN PROBE	22
BOX WITH FILTER INSTRUMENTS BOX	425
BOYNTON NEEDLE HOLDERS	110
BOYNTON NEEDLE HOLDERS T.C	119
BOYS-ALLIS TISSUE FORCEPS	338
BOZEMAN DRESSING FORCEPS	393
BOZEMANN HAEMOSTATIC FORCEPS	89
BOZEMANN NEEDLE HOLDERS	102
BOZEMANN NEEDLE HOLDERS T.C	112
BRAIN RETRACTOR SELF RETAINING	239
BRAIN SPATULAS	241,242
BRAND TENDON FORCEPS	209
BRAND TENDON TUNELLING FORCEPS	206
BRAUN OBSTETRICAL FORCEPS	408
BRAUN TENACULUM FORCEPS SHARP	386
BRAUN UTERINE DEPRESSOR	399
BRAUN VAGINAL RETRACTOR	374
BRAUN, MIDWIFERY DECAPITATING HOOK	395
BRAUN-STADLER PLASTER SCISSORS	52
BRAUNSTEIN CALIPER	294
BREAST DISSECTOR ANGULATED BLADE	163
BREAST DISSECTOR OVAL SPATULATED	163
BREAST DISSECTOR SPATULATED BLADE	163
BREAST DISSECTORS AND ELEVATOR	163
BREAST ELEVATOR FOR MAMMARY PLASTY	163
BREAST RETRACTOR, DOUBLE ENDED	166
BREAST RETRACTORS	166-167-168-169
BREAST SPATULA WITH HANDLE	166
BREISKY PELVIMETER, OBSTETRICAL FORCEPS	406
BREISKY SPECULUM	375
BREISKY SPECULUM VIENNA PATTERN	375
BREMERICH CHANNEL RETRACTOR	175
BREMERICH MANDIBULAR CHANNEL RETRACTOR	174
BRIESKY SPECULUM & RETRACTOR	373
BRINKERHOFF INTESTINAL RECTAL SPECULUM	351
BRISTOW BONE LEVER	207
BRISTOW'S BONE LEVER	204
BRISTOW-BANKART HUMERAL RETRACTOR	206
BRISTOW-BANKART SOFT TISSUE RETRACTOR	206
BRODIE DIRECTOR	21
BROM HOOKLET RETRACTORS	128
BRONCHO OESOPHAGOSCOPY FORCEPS	334
BROPHY DRESSING FORCEPS	62
BROPHY TISSUE FORCEPS	62
BROWN NEEDLE HOLDER	101
BRUENING MAGNIFIER OTOSCOPE	297
BRUENING SPATUALA	150
BRUENINGS SEPTATOME	309
BRUENINGS COMPLETE	297
BRUENINGS EAR SPECULUM COMPLETE SET	297
BRUENINGS NASAL CUTTING FORCEPS	319
BRUENINGS NASAL SPECULUM	302
BRUENINGS RETRACTOR	332
BRUENINGS TONGUE DEPRESSORS	325
BRUENINGS TONSIL KNIFE	309
BRUENINGS TONSIL SNARE	301
BRUENINGS-BRUNK ANTRUM RETRACTOR	322
BRUNER RETRACTOR	143
BRUNINGS TONSIL KNIFE	31
BRUNNER INTESTINAL POLYOUS GRASPING FORCEPS	345
BRUNNER RETRACTORS WITH FIBER OPTIC	175
BRUNNER RIB SHEARS	284
BRUNS BONE CURETTE	195-196
BRUNS SCISSORS	51
BUCK EAR POLYPUS FORCEPS	318
BUCK HAMMER	02
BUCK STITCH SCISSORS	43
BUCK, EAR CURETTE	307
BUCKET WITH LID	429
BUCKLEY RETRACTOR	151
BUELAU, TROCAR	16
BUIE HIRSCHMAN ANOSCOPE INTESTINAL RECTAL SPECULUM	352
BUIE SUCTION TUBE	22
BUNNELL DRILL	228
BUNNELL TENDON STRIPPERS	205-206
BURFORD RIB RETRACTORS	281
BURKE BIOPSY FORCEPS	381

DESCRIPTION	PAGE#
BURNHAM BANDAGE PLASTER SCISSORS	51
BUSCH PLASTER SCISSORS	52
BUTTERFLY GROOVED DIRECTOR WITH TONGUE TIE PLAIN END	21
BYRD, SUCTION TUBE	17
C	
C - CLAMP FORCEPS	231
CAIRNS HAEMOSTATIC FORCEPS	82
CAIRNS-DOTTUSHING TISSUE & DRESSING FORCEPS	66
CALLIPER FIXED	294
CANNULAS	291-415-416-417
CANNULAS CANNULAS FOR INILTRATION	409
CANNULAS FOR INILTRATION	409
CANNULATED WIRE / PIN CUTTER	219
CAPENER OSTEOTOME	186
CAPLAN SEPTUM FORCEPS	323
CAPSULE FORCEPS, LIGATURE CARRYING FORCEPS	359
CAPSULE RETRACTOR	206
CAPSULOTOMY SCISSORS VANNAS	289
CARMALT FORCEPS	75
CARPENTER ENUCLEATOR	312
CARROLL NEEDLE HOLDERS T.C.	111
CARROLL PERIOSTEAL ELEVATOR	204
CARROLL POCKET GONIOMETER	13
CARROLL TENDON FORCEPS	209
CARTILAGE AND BONE INSTRUMENTS	170
CARTILAGE CUTTING BLOCK, TEFLON	170
CASPAR BONE TAMPER	194
CASPAR RETRACTOR	137
CASPAR TYPE INTERVERTEBRAL DISC RONGEURS	248
CASSETTE FOR 10 INSTRUMENTS	431
CASSETTE FOR 20 INSTRUMENTS	431
CASSETTE FOR 4 INSTRUMENTS	431
CASSETTE FOR 5 INSTRUMENTS	431
CASSETTE FOR 6 INSTRUMENTS	431
CASSETTE FOR 7 INSTRUMENTS	431
CASSETTE FOR EXTRACTION FORCEPS	431
CASSETTE FOR ROOT ELEVATOR	431
CASSETTE TRAY 15 PCS	431
CAST SPREADER MODEL USA	211
CASTANEDA MULTIPURPOSE CLAMP & ATRAUMATIC CARDIOVASCULAR FORCEPS	276
CASTANEDA RIB RETRACTORS	282
CASTROVIEJO CALIPER	294
CASTROVIEJO BLADE BREAKER & HOLDER, WITH PUSH-PULL LOCK	26
CASTROVIEJO BONE CALIPER CURVED	13
CASTROVIEJO BONE CALIPER STRAIGHT	13
CASTROVIEJO CORNEAL MICRO SCISSORS	49
CASTROVIEJO EYE SPECULUM	151
CASTROVIEJO EYE VIEW CALIPER	151
CASTROVIEJO MICRO NEEDLE HOLDER T.C	120
CASTROVIEJO NEEDLE HOLDER	109-110-289
CASTROVIEJO NEEDLE HOLDERS T.C	118-119
CASTROVIEJO OLSEN HEGAR / NEEDLE HOLDERS / SCISSORS	110
CASTROVIEJO SCISSORS	48
CASTROVIEJO SCISSORS TIC INSERT	59
CASTROVIEJO TC	287
CASTROVIEJO-EPKER CALIPER	13
CATHER TRAY PERFORATED BOX	425
CATHETERS	362
CATLIN AMPUTATION	30
CATLIN DISSECTING KNIVES	30
CAWOOD-MINNESOTA CHEEK RETRACTOR	324
CEPSULOTOMY SCISSORS	288
CERVICAL BIOPSY AND SPECIMEN FORCEPS	380-381-382-384
CERVICAL TRACTION TONGS	236
CHALAZION CLAMP	285
CHALAZION FORCEPS	285
CHANDLER BONE ELEVATOR	203
CHAPUT HAEMOSTATIC FORCEPS	95
CHAPUT TISSUE FORCEPS	339
CHARNLEY TISSUE FORCEPS	63
CHARNLEY-MUELLER	233
CHARRIERE AMPUTATION & RESECTION	32
CHARRIERE BONE SAW	182
CHARRIERE BONE SAW COMPLETE	182
CHARRIERE SAW	182
CHEATEL STERILIZING FORCEPS BOX JOINT	434
CHEATEL STERILIZING FORCEPS SCREW JOINT	434
CHEEK AND LIP RETRACTOR D/E	175
CHEEK RETRACTOR	324
CHEEK-AND LIP RETRACTOR	145
CHELSEA-EATON INTESTINAL RECTAL SPECULUM	352
CHERON FORCEPS	99
CHERRY RIB RETRACTORS	279
CHEVALIER-JACKSON FORCEPS	334
CHEVALIER-JACKSON TRACHEA TUBES	331
CHICHIRELLI (BLUMENTHAL) RONGEUR	212
CHILD HERNIA DIRECTOR	367
CHILDE TISSUE FORCEPS	75
CHISEL	184-186-187
CHISEL BLADE HANDLE	184
CHISEL BLADE KEY	184
CHISELS, OSTEOTOMES FOR RHINOPLASTIC	190
CHRISTOPHE HAEMOSTATIC FORCEPS	81
CILIA FORCEPS	74
CINELLI CHISEL	189
CIRCUMCISION SHIELD	364

DESCRIPTION	PAGE#
CITELLI BONE EAR RONGEURS	321
CLARK SPECULUMS	294
CLEVELAND BONE CUTTING RONGEUR FORCEPS	216
CLEVELAND BONE RONGEUR	213
CLEVELAND-GARDNER BONE CUTTING RONGEUR FORCEPS	217
CLIPS & APPLYING FORCEPS	241
CLIPS MAYO	23
CLOWARD INTERVERTEBRAL DISC RONGEURS	248
CLOWARD RETRACTOR	237
CLOWARD VERTIBRAL CERVICAL SPREADER	236
CLUTTON BOUGIES	362
COAKLEY ANTRUM CURETTE	310
COAKLEY UTERINE DEPRESSOR	399
COAKLEY, TROCAR	15
COARCTATION CLAMPS	267
COBB CHISEL / OSTEOTOMES	190
COBB GOUGE	190
COBB MODIF	194
COBB PERIOSTEAL ELEVATOR	204
COBB SPINAL ELEVATOR	194
COHEN NIPPERS	47
COLE-PARMER DISSECTING BLADE REMOVER FOR BLADE HANDLE	26
COLIBRI FORCEPS	285-285-287
COLLER HAEMOSTATIC FORCEPS	81
COLLIER NEEDLE HOLDERS	105
COLLIN DISSECTING KNIVES	28,30
COLLIN DRESSING HAEMOSTATIC FORCEPS	96
COLLIN FORCEPS	76
COLLIN GRASP FORCEPS	340
COLLIN KIDNEY ELEVATING STONE CLAMPS FORCEPS	357
COLLIN MALLETS	191
COLLIN OBSTETRICAL FORCEPS	404
COLLIN PELVIMETER, OBSTETRICAL FORCEPS	406
COLLIN RETRACTOR	141-159-160
COLLIN RIB SHEARS	284
COLLIN SCALPEL HANDLE # 9 BLADE	26
COLLIN SPONGE & DRESSING FORCEPS	97,100
COLLIN TISSUE GRASPING FORCEPS	340
COLLIN VAGINAL SPECULUM	370
COLLIN VIRGIN SPECULAUMS	370
COLLIN-DUVAL FORCEPS	65
COLLING DRESSING HAEMOSTATIC FORCEPS	96
COLLIN-HARTMANN RETRACTOR	132
COLLINTISSUE GRASPING FORCEPS	340
COMBINATION Mallet	191
COMPRESSION POSITIONING DRILL BIT	231
COMYN BERKELEY VULVA SELF RETAINING RETRACTOR	379
CONCAVE FREEMAN HOOK RETRACTOR	177
CONDUCTORREVERDIN NEEDLES	122
CONE KNIFE	31
CONE RETRACTOR	156
CONVENTIONAL LARYNGOSCOPE SET	04,05
CONVERSE BLADE NASAL RETRACTOR	172
CONVERSE HOOK	128
CONVERSE NASAL KNIFE	309
CONVERSE NEEDLE HOLDERS T.C	115
CONVEX FREEMAN HOOK RETRACTOR	177
COOLEY ANASTOMOSIS CLAMPS	275
COOLEY BLADE AORTIC DILATOR	278
COOLEY EYE FORCEPS	287
COOLEY INTRACARDIAC NEEDLE HOLDERS	107
COOLEY INTRACARDIAC NEEDLE HOLDERS T.C	115
COOLEY MULTI PURPOSE VASCULAR CLAMPS	276
COOLEY PEDIATRIC VASCULAR CLAMPS	275
COOLEY REVERSE CUT SCISSORS	41
COOLEY RIB RETRACTORS	279,280
COOLEY VASCULAR FORCEPS	265
COOLEY VASCULAR SCISSORS	42
COOLEY, SUCTION TUBE	17
COOLEY-BAUMGAFTEN WIRE TWISTER NEEDLE HOLDERS T.C	116
COOPER NEEDLE	123
CORD HOOK	367
CORNEAL FORCEPS	285,287
CORNEAL SCISSORS	288
CORONAL BROW LIFT RETRACTOR	177
CORWIN #3R ROUND SCALPEL HANDLE	25
CORWIN NEEDLE HOLDERS T.C	121
CORWIN ROUND #4R SCALPEL HANDLE	25
CORYLLOS RETRACTOR	142
COTTLE ALAR RETRACTOR	171
COTTLE CARTILAGE CRUSHER	170,322
COTTLE CHISEL	189
COTTLE GUIDE SUPPORT FOR OSTEOTOMES	322
COTTLE HANDLE	322
COTTLE MALLETS	191
COTTLE NASAL KNIFE	309
COTTLE NASAL SAW	314
COTTLE NASAL SPECULUM	306
COTTLE OSTEOTOMES	187,189
COTTLE PERIOSTEAL ELEVATOR	164
COTTLE PERIOSTEAL ELEVATOR/RASPATORY	165
COTTLE PERIOSTEAL SEPTUM ELEVATORS	312
COTTLE RETRACTOR	132
COTTLE SCISSORS	44
COTTLE SEPTUM ELEVATORS RASPATORY	311
COTTLE-KAZANJIAN BONE CUTTING RONGEUR FORCEPS	216
COTTLE-WALSHAM SEPTUM FORCEPS	322
COTTON CARRIER	383

DESCRIPTION	PAGE#
COTTON HOLDER	429
COUNTERSINK	230
COUPLAND SUCTION TUBE	17
COUPLING PIECE ASPIRATING CURETTE	397
CRAFOORD HAEMOSTATIC FORCEPS	85
CRAFOORD-SELLORS HAEMOSTATIC FORCEPS	86
CRAIG NASAL POLYPUS AND SEPTUM FORCEPS	317
CREGO PERIOSTEAL ELEVATOR	201
CRILE HAEMOSTATIC FINE POINT FORCEPS	80
CRILE HAEMOSTATIC FORCEPS	80
CRILE HAEMOSTATIC TISSUE FORCEPS	80
CRILE HOOKLET & SKIN HOOKS	128
CRILE NEEDLE HOLDERS	108
CRILE RETRACTOR	139
CRILE-MURRAY NEEDLE HOLDERS	106
CRILE-WOOD NEEDLE HOLDER	102
CRILE-WOOD NEEDLE HOLDERS T.C	111
CRUTCHFIELD DRILL BIT	236
CRUTCHFIELD SKULL	236
CRUTCHFIELD TRACTION TONGS	236
CUP SHAPED BRONCHO OESOPHAGOSCOPY FORCEPS	335-336
CUP SHAPED FORCEPS	334
CURETTE	198,199,292
CUSCO VIRGIN SPECULAUMS	370
CUSCO VAGINAL SPECULUM	369
CUSCO VAGINAL SPECULUM FOR VIERGES	369
CUSCO VAGINAL SPECULUM SWISS PATTERN	369
CUSHING DECOMPRESSION RETRACTOR	208
CUSHING DRESSING FORCEPS T.C	78
CUSHING HAND DRILL BIT	235
CUSHING HOOKLET RETRACTORS	133
CUSHING INTERVERTEBRAL DISC RONGEURS	247,248
CUSHING LAMINECTOMY RONGEUR	247
CUSHING NERVE DURA HOOK	242
CUSHING NERVE DURA HOOK RETRACTOR	243
CUSHING NERVE HOOK	244
CUSHING PERIOSTEAL ELEVATOR	203,204
CUSHING TISSUE FORCEPS T.C	78
CUSHING VEIN RETRACTOR	208
CUSHING, BRAIN SPATULA	241
CUSHING-KOCHER HOOKLET RETRACTORS	133
CUZZI OVUM CURETTE	405
CZERNY RECTAL SPECULUM	350
CZERNY TENACULUM FORCEPS	385
D	
D'ERRICO FORCEPS	68
DAHLGREN CRANIAL RONGEUR	238
DANDY HAEMOSTATIC FINE POINT FORCEPS	80
DANDY HAEMOSTATIC FINE POINT TISSUE FORCEPS	80
DANDY HAEMOSTATIC FORCEPS	80
DANDY HAEMOSTATIC TISSUE FORCEPS	80
DANDY NERVE DURA HOOK	243
DARLING RETRACTOR	152
DARRACH ELEVATOR	204
DARTIGUES UTERINE ELEVATING FORCEPS	357
DAUBENSPECK BONE CURETTE	197
DAVIDSON RETRACTOR	142
DAVIS DURA DISSECTOR	242,244
DAVIS GUIDE FOR GIGLI SAWS	238
DAVIS STERILIZING FORCEPS	434
DAVIS-BOYLE MOUTH GAG HANDLE	328
DAVIS-BOYLE MOUTH GAG COMPLETE SET WITH FIVE BLADES	328
DAY HOOKLET & SKIN HOOKS	128
DE BAKERY BECK MULTI PURPOSE VASCULAR CLAMPS	273
DE BAKERY BULLDOG CLAMPS	264
DE BAKERY DRESSING FORCEPS T.C	76
DE BAKERY FEMUR RETRACTOR	157
DE BAKERY LIGATURE FORCEPS	268
DE BAKERY MULTI PURPOSE VASCULAR CLAMPS	272,273,274
DE BAKERY NEEDLE HOLDERS	106
DE BAKERY NEEDLE HOLDERS T.C	116
DE BAKERY PEDIATRIC VASCULAR CLAMPS	275
DE BAKERY PERIPHERAL VASCULAR CLAMPS	269,270
DE BAKERY SUCTION TUBE	17
DE BAKERY VASCULAR FORCEPS	265
DE BAKERY VASCULAR SCISSORS	41,42
DE BAKERY-MOSQUITO VASCULAR FORCEPS	266
DE BAKERY-RANKIN VASCULAR FORCEPS	266
DE LEE OBSTETRICAL FORCEPS	407
DE LEE PELVIMETER, OBSTETRICAL FORCEPS	406
DE MARTEL SAW CONDUCTOR	238
DE MARTEL-WOLFSON ANASTOMOSIS CLAMPS	348
DE MARTEL-WOLFSON CLAMP HOLDER	348
DE MARTEL-WOLFSON CLOSING FORCEPS	348
DE VILBISS SKULL FORCEPS	238
DE VILBISS VIRGIN SPECULAUMS	370
DEAN (BLUMENTHAL) RONGEUR	212
DEAN RONGEUR	212
DEAN-DELLICATE DISSECTING SCISSORS	42
DEAVER OPERATING SCISSORS	35
DEAVER RETRACTOR	144,174
DEBAKEY RIB RETRACTOR	279
DEBAKEY CARDIOVASCULAR NEEDLE HOLDERS	107
DEBAKEY CARDIOVASCULAR NEEDLE HOLDERS T.C	116
DEBAKEY DRESSING FORCEPS T.C	78
DEBAKEY GELPI RETRACTOR	152
DEBAKEY RIB RETRACTOR	279

DESCRIPTION	PAGE#
DE-BAKEY-BAHNSON TANGENTIAL OCCLUSION FORCEPS	271
DEBAKEY-COLEY RETRACTOR	146
DEBAKEY-VASCULAR/EXTRA LIGHT NEEDLE HOLDERS T.C	116
DECKER INTERVERTEBRAL DISC RONGEURS	249
DEJERINE HAMMER	02
DELICATE WIRE CUTTER	220
DENHART MOUTH GAG	326
DENIS-BROWNE RETRACTOR	160
DERF NEEDLE HOLDERS	105
DERF NEEDLE HOLDERS T.C	115
DERMATOMES - TRANSPLANTATION KNIVES	32
DERRA MULTI PURPOSE VASCULAR CLAMPS	274
D'ERRICO-ADSON RETRACTOR	155
DESCHAMPS NEEDLE	123-124
DESJARDIM (SET 3 PIECES)	23
DESJARDINS GALL STONE FORCEPS	358
DESJARDINS HAEMOSTATIC FORCEPS	87
DESJARDINS PROBE & CATCH WITH FLEXIBLE	361
DESMARRES LID RETRACTORS	133
DIAGNOSTIC PENTOSCOPE SET	06
DIAGNOSTIC SETS	07,08,10
DICK HAEMOSTATIC FORCEPS	92
DIEFFENBACH DISSECTING KNIVES	28,30
DIEFFENBACH KNIVES	28
DIETHRICH VASCULAR FORCEPS	266
DINGMAN BONE CLAMP	222
DINGMAN CARTILAGE ABRADERS SET OF TWO	170
DINGMANN CLEFT PALATE REPAIR MOUTH GAG	327
DIRECTOR PROBE END	21
DIRECTORS	21
DISSECTING & GYNECOLOGICAL SCISSORS	36,40
DISSECTING & NASAL SCISSORS	42
DISSECTING DRESSING FORCEPS	64
DISSECTING FORCEPS	62
DISSECTING KITS	11,12
DISSECTING KNIFE WITH METAL HANDLE	29
DISSECTING KNIVES	29,30,31
DISSECTING SCISSORS INCISION OPERATING SCISSORS	35
DISSECTING SET - POPULAR	11
DISSECTING SET - PRO	11
DISSECTING SET - SENIOR	11
DISSECTING SET- ADVANCED	11
DISSECTING SET OF 12 PCS.	11
DISSECTING SET OF 6 PCS.	11
DISSECTING TISSUE FORCEPS T.C	78
DISSECTORS AND ELEVATORS	164,165,171
DITTEL URETHRAL BOUGIES AND DILATING SOUNDS	363
DIXON-LOVELACE HAEMOSTATIC FORCEPS	86
DOUBLE ACTION WIRE CUTTER	220
DOUBLE PRONG MICRO HOOK & SKIN HOOK	127
DOUGLAS CILIA FORCEPS	74
DOUGLAS TROCAR	15
DOWNING CARTILAGE KNIFE	205
DOYEN DIRECTORS	21
DOYEN INTESTINAL FORCEPS CLAMPS	343,344,345
DOYEN MALLETS	191
DOYEN MYOMA SCREW AND FISTULA HOOK	396
DOYEN NEEDLE HOLDERS	105
DOYEN OPERATING, DISSECTING SCISSORS	39
DOYEN POZZI RETRACTOR	379
DOYEN PROBES & DIRECTORS	21
DOYEN RETRACTOR	145
DOYEN RIB RASPARTORY	200
DOYEN RIB SHEARS	284
DOYEN SPECULUM & RETRACTOR	377
DOYEN SUPRA HOLLOW HANDLE	379
DOYEN TONGUE SPATULA	325
DOYEN TOWEL FORCEPS	93
DOYEN VAGINAL FLAT RETRACTOR	392
DOYEN VAGINAL RETRACTORS	148
DOYEN VAGINAL SPECULUM	374
DOYEN-BABY INTESTINAL CLAMP	343,344
DRESSING JAR	428
DRESSING JAR WITH KNOB	428
DRILL GUIDE	230
DRILL GUIDE WITH THREAD	231
DRILL POINTED GUIDE	231
DRILL SLEEVES	231
DUCKBILL EAR FORCEPS	333
DUEHRSSEN DRESSING FORCEPS	65
DUEHRSSEN TISSUE FORCEPS	65
DUKE TROCAR	15
DUMONT FORCEPS	73
DUPLOY SPONGE & DRESSING FORCEPS	97
DUPLOY SPONGE FORCEPS	99
DUPLOY TENACULUM FORCEPS	386
DUPLEX STETHOSCOPE	01
DUPLEX-BABY STETHOSCOPE	01
DURA DISSECTORS	244
DURA DISSECTORS	245
DURANTE TISSUE GRASPING FORCEPS	64
DUST BIN	430
DUVAL GRASP FORCEPS	339
DUVAL INTESTINAL & TISSUE GRASPING CLAMP FORCEPS T.C	342
DUVAL INTESTINAL AND TISSUE GRASPING CLAMP FORCEPS	342
DUVAL LUNG TISSUE FORCEPS	341
DUVAL TISSUE GRASPING FORCEPS	341
DUVAL-COLLIN GRASP FORCEPS	339

DESCRIPTION	PAGE#
E	
EAR CURETTES	307
EAR CURETTES AND SHARP SPOONS	308
EAR FORCEPS	333
EAR LOOPS - HOOKS	308
EAR POLYPUS FORCEPS	318
EAR POLYPUS SNARES	301
EAR SPECULA	296,297
EAR SPECULA, ATOMIZER	298
EAR SPECULUM	295
ECHLIN DUCKBILL BONE RONGEUR	214
EICKEN SUCTION & IRRIGATION CANNULA	19
EISELSBERG-MATHEIU NEEDLE HOLDERS T.C	121
ELLIOT OBSTETRICAL FORCEPS	407
ELSASSER NEPHROSTOMY FORCEPS	356
EMMET FISTULA HOOK	396
EMMET SPONGE & DRESSING FORCEPS	99
ENDOSCOPE BASKET	433
ENDOTHELIAL GRASPING FORCEPS	290
ENEMA CANE	430
ENGEL PLASTER SAW	182
ENGL. MODELL TOWEL FORCEPS	93
ENT MEDICAL DIAGNOSTIC SET	07,08
ENT SPECULA	07,08
ENT-DEAN SCISSORS	42
ENT-DEAN SCISSORS T/C INSERT	58
ENTNER CANNULAS	410,411,412
EPENDORF BIOPSY FORCEPS	381
EPENDORF BIOPSY AND SPECIMEN FORCEPS	380
ESMARCH KNIFE	51
ESMARCH SCISSORS	51
EUFRATE PASQUE T.C NEEDLE HOLDERS	114
EUSTACHIAN CATHETERS	20
EVANS DRESSING FORCEPS T.C	78
EVANS PELVIC NEEDLE DRESSING FORCEPS T.C	78
EVES TONSIL SNARE	301
EXTENSION BOWS	233
EXTRA 3CM NYLON FACE	191
EXTRA ORAL RETRACTOR	175
EYE FORCEPS	285,286,287
EYE HOLDERS	288
EYE INSTRUMENTS	291
EYE KNIVES	293
EYE SPECULUMS	292
F	
FACE CANNULAS	413
FANSLER OPERATING INTESTINAL RECTAL SPECULUM	352
FARABEUF BONE HOLDING FORCEPS	223
FARABEUF ELEVATOR	201
FARABEUF RETRACTOR	140,141
FARABEUF-COLLIN ELEVATOR	201
FARABEUF-LAMBOTTE BONE HOLDING FORCEPS	223
FARR WIRE RETRACTOR	151
FARRELL APPLICATOR	308
FARRELL ROUND SERRATED END	23
FAT INJECTION SYRINGES	423
FAT SUCTION SYRINGES	423
FAULKNER ANTRUM CURETTE	310
FAURE HAEMOSTATIC TISSUE FORCEPS	90
FAURE UTERINE BIOPSY FORCEPS	384
FAVALORO CORONARY SCISSORS	42
FECHTNER CONJUNCTIVA FORCEPS	286
FEHLAND INTESTINAL POLYOUS GRASPING FORCEPS	345
FEILCHENFELD FORCEPS	74
FEIN COTTON APPLICATOR	22
FEMALE BLADDER SOUNDS	393
FEMALE CATHETERS	393
FENESTRATED HANDLE	71
FERGUSON-MOON RECTAL RETRACTORS	148
FERGUSON BONE HOLDING FORCEPS	222
FERGUSON SUCTION TUBES	18
FERGUSON TUBING CLAMP	94
FERGUSON-ACKLAND MOUTH GAG	326
FERRERA BREAST AUGMENTATION RETRACTOR	167,168
FERRERA FACE LIFT RETRACTOR	174
FERRIERA STYLE RETRACTOR	166
FERRIS SMITH MICRO KERRISON LAMINECTOMY RONGEURS	250,253
FERRIS SMITH MICRO KERRISON LAMINECTOMY RONGEURS DOWNWARD	250
FERRIS SMITH MICRO KERRISON LAMINECTOMY RONGEURS UPWARD	250
FERRIS-SMITH INTERVERTEBRAL DISC RONGEURS	254
FERRIS-SMITH KERRISON LAMINECTOMY PUNCH	261
FERRIS-SMITH TISSUE FORCEPS	64
FERROZELL PERIOSTEAL ELEVATOR	203
FIBER OPTIC LARYNGOSCOPE	03
FIBER OPTIC LARYNGOSCOPE MILLER	04
FIBULA BONE HOLDING FORCEPS	227
FINGER NAIL DRILL	209
FINGER RAKE, RETRACTOR	130
FINOCCHIETTO (MODIF.) RIB RETRACTORS	280
FINOCCHIETTO NEEDLE HOLDERS	102
FINOCCHIETTO, RIB RETRACTORS	280,282
FINOCCHIETTO/BABY RIB RETRACTORS	282
FINOCCHIETTO NEEDLE HOLDERS	108
FINOCCHIETTO NEEDLE HOLDERS T.C	113,114
FINOCCHIETTO RETRACTORS	158
FINOCCHIETTO RETRACTORS	158

DESCRIPTION	PAGE#
FINSEN RETRACTOR	150
FISCH HOOKLET & SKIN HOOK	127
FISCH SUCTION & IRRIGATION CANNULA	19
FISCHER TENDON STRIPPERS	295
FISCHER TONSIL KNIFE AND DISSECTOR	309
FISTULA HOOK	396
FIXATION HOOK	293
FLAP DISSECTOR	163
FLAT NOSE K-WIRE PLIERS	210
FLAT NOSE PLIERS	209,210,211
FLETCHER SPONGE FORCEPS	98
FLEURANT TROCAR	16
FLEXIVAL ABDOMINAL SPATULA	150
FLUSH WIRE CUTTER	220
FLUSHING CURETTES	398
FOERSTER-BALLENGER SPONGE FORCEPS	100
FOMAN OPERATING SCISSORS T/C INSERT	59
FOMAN RASP	183
FOMON CHISEL	189
FOMON NASAL KNIFE	309
FOMON NASAL RETRACTOR	172
FOMON NASAL SAW	314
FOMON RASP	184
FOMON RASP WITH TUNGSTEN CARBIDE TC	313
FOMON SCISSORS	44
FORAMENOTOMY KERRISON LAMINECTOMY RONGEURS	252
FORCEPS FOR I.U.D REMOVING	392
FORCEPS JAR	429
FORIGN BODY FORCEPS	318
FORIGN BODY LEVER	318
FÖRSTER CONJUNCTIVA FORCEPS	286
FOWLER TONSIL KNIFE	31
FRAENKEL LARYNGEAL POLYPUID FORCEPS	337
FRAZIER HOOKLET & SKIN HOOK	127
FRAZIER 30° SUCTION TUBES	18
FRAZIER 45° SUCTION TUBES	18
FRAZIER NERVE DURA HOOK	243
FRAZIER NERVE DURA HOOK RETRACTOR	243
FRAZIER SUCTION TUBES	18
FREEMAN AREOLA MARKER	162
FREEMAN FLAP RETRACTOR	174
FREEMAN HOOK RETRACTOR	177
FREEMAN RETRACTOR HOOK RETRACTOR	177
FREER CHISEL	187
FREER D SEPTUM KNIFE	205
FREER ELEVATOR	199
FREER GOUGE	187
FREER NASAL KNIFE	309
FREER SEPTUM ELEVATOR	165
FREER SEPTUM ELEVATORS RASPARTORY	311
FREER SKIN HOOK	127
FREER TONSIL KNIFE	308
FRENCH TUNING FORK	299
FRENCH-EYE NEEDLE HOLDERS T.C	113
FRENCH-EYE NEEDLE HOLDER	107
FRENCH-EYE NEEDLE HOLDERS T.C	113
FRICKE ARTERY FORCEPS	93
FRIEDMANN BONE RONGEUR	211
FRIEDMANN RETRACTOR	379
FRITCH RETRACTOR	145
FRIJSCH RETRACTOR	145,146
FRONT & SIDE WIRE CUTTER	220
FRONTOGLABELLAR DISSECTOR	164
FRONTOTEMPORAL DISSECTOR	164
FRYKHOLM BONE RONGEUR	215
FUNNAL	430
G	
G LOVES BOX	425
GALIPOTS	429
GALL DUCT DILATOR	361
GALL STONE FORCEPS	358
GALLAHER BONE RASP	183
GALLAHER NASAL SAW	314
GALT BRACE HAND DRILL	235
GANSEN EAR CURETTE	308
GARRIGUE WEIGHTED VAGINAL SPECULUM	377
GASPAROTTI CANNULAS	418
GELLHORN BIOPSY FORCEPS	384
GELPI SKIN & VEGINAL RETRACTOR	157
GELPI VEGINAL RETRACTOR	157
GELPI VULVA SELF RETAINING	392
GELPI-LOKTITE RETRACTOR	153
GELPI-PERINEAL RETRACTOR	153
GEMINI MIXTER HAEMOSTATIC FORCEPS	92
GERALD TISSUE & DRESSING FORCEPS	66
GERARD TISSUE & DRESSING FORCEPS	66
GERL TYING FORCEPS	286
GERSTER BONE HOLDING CLAMP	221
GERSTER-LOWMANN BONE CLAMP	221
GIERTZ-STILLE RIB SHEARS	284
GIGLE, WIRE SAW	238
GIGLE-STULLY HANDLE FOR WIRE SAW	238
GILLIES NEEDLE HOLDERS	104
GILLIES NEEDLE HOLDERS T.C	114
GILLIES SKIN HOOK	127
GILLIES SLIM T.C NEEDLE HOLDERS WITH SCISSORS	116
GILLIES TISSUE FORCEPS	62

DESCRIPTION	PAGE#
GILLIES TISSUE FORCEPS T.C	76
GILLS - VANNAS	289
GLENOID PERFORATING FORCEPS	227
GLOVER BULLDOG CLAMPS	264
GLOVER MULTI PURPOSE VASCULAR CLAMPS	274
GLUCK RIB SHEAR	283
GOELET RETRACTOR	146
GOLDMAN SRPTUM DISPLACER	312
GOLDMAN-FOX SUPER CUT SCISSORS	55
GOLDMANN-FOX OPERATING SCISSORS T/C INSERT	58
GOOD BONE FILE / RASP	183
GOOD SCISSORS	45
GORNEY SUCTION TUBES	17
GOSSET ABDOMINAL RETRACTORS	158
GOSSET BLADDER RETRACTOR	366
GOSSET RETRACTOR	158
GOUGE	184,185,187
GRADLE CILIA FORCEPS	74
GRAEFE DRESSING FORCEPS	72
GRAEFE FIXATION FORCEPS	72
GRAEFE FORCEPS	72
GRAEFE TISSUE & DRESSING FORCEPS	66
GRAEFE TISSUE FORCEPS	72
GRAHAM NERVE DURA HOOK	243
GRASPING BRONCHO OESOPHAGOSCOPY FORCEPS	335
GRASPING FORCEPS FLEXIBLE SHAFT	354
GRAVE VAGINAL SPECULUM	369
GRAVES VAGINAL SPECULUM LEEP / LIETZ	370
GRAVES VIRGIN SPECULAUMS	370
GREEN-ARMYTAGE UTERINE ELEVATING FORCEPS	404
GRONINGEN NERVE HOOK	244
GROSS EAR CURETTE	308
GROSS EAR SPOON	308
GROSS MAIER DRESSING FORCEPS	96,97
GROSS MAIER DRESSING SPONGE & DRESSING FORCEPS	96,97
GROSSMANN AREOLA MARKER	162
GRUBER AURAL SPECULA EAR SPECULUM	296
GRUBER COMBINATION KNIFE HANDLE / PERICHONDRIUM ELEVATOR #7	165
GRUBER EAR SPECULUM	295
GRUENWALD FORCEPS	68
GRUENWALD TISSUE FORCEPS	68
GUBISCH AUFRICHT NASAL RETRACTOR	171
GUBISCH CARTILAGE CRUSHER	170
GUM & OPERATING SCISSORS	45
GUMCO CIRCUMCISION CLAMP	364
GUTHRIE HOOKLET	127
GUTMANN SECRETIONS SCOOP	367
GUYON URETHRAL BOUGIES AND DILATING SOUNDS	363
GUYON URETHRAL CATHETERS	362
GWILLIAM UTERUS HOLDING FORCEPS	387
H	
HAASE REDUCTION FORCEPS	226
HABERER STOMACH INTESTINAL TWIN CLAMP FORCEPS	346
HAEMOSTATIC FORCEPS 79,80,81,82,83,84,85,86,87,88,89,90,91,92,94,95,96,97,98,99, .	100
HAEMOSTATIC TISSUE FORCEPS	86
HAIGHT RIB RETRACTOR	280
HAJEK BALLINGER SEPTUM ELEVATOR	165
HAJEK HAMMER	192
HAJEK MALLETS	191
HAJEK RONGEUR PUNCH	321
HAJEK-CLAUS RONGEUR PUNCH	321
HAJEK-KOFLER RONGEUR PUNCH	321
HAKANSSON BONE RONGEUR	218
HALLE BONE CURETTE	195
HALLE NERVE DURA HOOK	242
HALLE SCISSORS	45
HALLE SEPTUM ELEVATOR	165
HALOGEN ILLUMINATION	03
HALSEY NEEDLE HOLDERS	105
HALSEY NEEDLE HOLDERS T.C	114
HALSTED HAEMOSTATIC FINE POINT FORCEPS	81
HALSTED HAEMOSTATIC FORCEPS	81,85
HALSTED-MOSQUITO HAEMOSTATIC FORCEPS	79
HAND DRILLS	228,229,235
HANK DOUBLE ENDED	390
HANK UTERINE DILATORS 6 SET	389
HANK UTERINE DILATORS, DOUBLE-ENDED	389
HARD WIRE CUTTER CUTS	219
HARDY NEURO-MICRO DISSECTOR	245
HARDY-DUDDY SPECULUM	378
HARRINGTON EXTRA DEEP RETRACTOR	146
HARRINGTON RETRACTOR	146
HARRINGTON RETRACTORS WITH FIBER OPTIC	176
HARRINGTON SPINAL ELEVATOR	194
HARRINGTON SPANLCHNIC RETRACTOR	146
HARRIS CAPSULE LIGATURE ANGLED SUTURE FORCEPS	359
HARTMAN EAR FORCEPS	333
HARTMANN BONE RONGEUR	213
HARTMANN CHEEK RETRACTOR	324
HARTMANN EAR FORCEPS	333
HARTMANN EAR POLYPUS FORCEPS	318
HARTMANN EAR SPECULUM	296
HARTMANN EUSTACHIAN CATHETERS	20,298
HARTMANN NASAL CUTTING FORCEPS	320
HARTMANN NASAL POLYPUS AND SEPTUM FORCEPS	317
HARTMANN NASAL SPECULUM	303

DESCRIPTION	PAGE#
HARTMANN TONSIL GUILLOTINES & PUNCH FORCEPS	316
HARTMANN TUNING FORK	299,300
HARTMANN TUNING FORKS SET	300
HARTMANN, EUSTACHIAN CATHETERS	20
HARTMANN-HALLE NASAL SPECULUM	303
HARTMANN-HOFFMANN EAR FORCEPS	333
HARTMANN-NOYES EAR FORCEPS	333
HARTMANN-WEINGARTNER EAR FORCEPS	333
HARTMANN-WULLSTEIN EAR FORCEPS	333
HAWKIN AMBLER DILATORS	390
HAYES HAND RETRACTOR	207
HAYES SIGMOID ANASTOMOSIS FORCEPS	344
HEANEY / BALLANTINE HAEMOSTATIC FORCEPS	86
HEANEY / REZAK HAEMOSTATIC FORCEPS	87
HEANEY ATRAUMATA HYSTERECTOMY FORCEPS	91
HEANEY HAEMOSTATIC FORCEPS	88
HEANEY MODIF. HAEMOSTATIC FORCEPS	88
HEANEY NEEDLE HOLDERS	104
HEANEY UTERUS HOLDING FORCEPS	387
HEANEY-GYNE NEEDLE HOLDERS T.C	117
HEANEY-KANTER HAEMOSTATIC FORCEPS	88
HEATH MALLETS	192
HEATH VASCULAR SCISSORS	42
HEAVYWEIGHT	192
HEGAR DOUBLE ENDED DILATORS	390
HEGAR UTERINE DILATOR	389,391
HEGAR UTERINE DILATOR, DOUBLE-ENDED	389
HEGAR UTERINE DILATORS 8 SET W/ROLL	389
HEGEMANN-DIETRICH VASCULAR SCISSORS	41
HEGENBARTH TISSUE FORCEPS	75
HEIFETZ, BRAIN SPATULA	241
HEIMING KIDNEY STONE FORCEPS	356
HEISS RETRACTOR	150
HEISTER MOUTH GAG	326
HELFERICH-BIER SAW	182
HEMORRHOIDAL LIGATOR-SUCTION	353
HENKE TONSIL DISSECTOR	312
HENNIG PLASTER CAST SPREADER	54
HENROTIN WEIGHTED VAGINAL SPECULUM	377
HEPP-SCHIEDL MICRO NEEDLE HOLDER	118
HERBERT MALLETS	193
HERNIA DIRECTOR, VASECTOMY FORCEPS, CLAMP & BLADDER RETRACTOR	367
HERRICK HAEMOSTATIC FORCEPS	86
HERTZLER RETRACTOR	158
HERTZLER RIB RETRACTORS	281
HERZ TENDON SEIZING FORCEPS	99
HERZFELD RETRACTOR	132
HEX HANDLE OSTEOTOME	187
HEXAGONAL HEAD	230
HEY GROVES BONE HOLDING FORCEPS	223
HEYMANN NASAL DRESSING FORCEPS	319
HEYMANN SCISSORS	44
HEYMANN-KNIGHT NASAL POLYPUS AND SEPTUM FORCEPS	317
HEYWOOD SMITH SPONGE FORCEPS	99
HEYWOOD-SMITH POLYPUS GRASPING FORCEPS	341
HEYWOOD-SMITH SPONGE & DRESSING FORCEPS	100
HIBBS	188
HIBBS CHISEL	188
HIBBS CHISEL / OSTEOTOMES	190
HIBBS CHISEL ENDOSCOPIC	190
HIBBS GOUGE	188
HIBBS GOUGS ENDOSCOPIC	190
HIBBS OSTEOTOME	188
HIBBS OSTEOTOMES ENDOSCOPIC	190
HIBBS RETRACTOR	208
HILL FERGUSON RECTAL RETRACTORS	148
HIRSCHMAN ANOSCOPE INTESTINAL RECTAL SPECULUM	352
HIRSCHMANN INTESTINAL RECTAL SPECULUM	351
HOEN FORCEPS	68
HOEN NERVE DURA HOOK	242
HOEN PERIOSTEAL ELEVATOR	203,204
HOHMANN BONE ELEVATOR	206
HOHMANN BONE LEVER	207
HOHMANN LONG SHANK RETRACTOR	207
HOHMANN RETRACTOR	207
HOHMANN-WILLIGER RETRACTOR	208
HOKE OSTEOTOME	188,189
HOLDING & FOLDING FORCEPS	285
HOLDING & FOLDING FORCEPS FOR ACRYLIC LENSES	285,286
HOLE LIPOSUCTION CANNULA	422
HOLLOWARE INSTRUMENTS	425,426,427,428,429,430,431,432
HOLSHER NERVE ROOT RETRACTOR	242
HOOKLET & SKIN HOOKS	127,128
HOOKLET BUTTONED EAR LOOPS - HOOKS	308
HOOKLET EAR LOOPS - HOOKS	308
HOOKLETS RETRACTORS	129,128,130,131,132
HORMONE IMPLANT TROCAR SET	393
HORSLEY BONE CUTTING RONGEUR FORCEPS	217
HORSLEY DURA DISSECTOR	244
HOUSE SUCTION TUBES	18
HOUZEL RETRACTOR	152
HOWARTH PERIOSTEAL ELEVATOR	202
HOWARTH SEPTUM ELEVATOR	165
HUBER RETRACTOR	332
HUBSON, BRACE HAND DRILL	235
HUDSON BRACE	229,235
HUDSON CERABELLAR EXTENSION	235
HUDSON TISSUE & DRESSING FORCEPS	70

DESCRIPTION	PAGE#
HULKA-KENWICK UTERINE ELEVATING & MANIPULATING FORCEPS	357
HUMBY DERMATOMES	32
HUMERAL HEAD RETRACTOR	206
HUNT FORCEPS	68
HUNT TUMOR-AND VESSEL FORCEPS	67
HUNTER FORCEPS	75
HUNTER UTERUS HOLDING FORCEPS	387
HURD TONSIL DISSECTOR	312
HUSON HAND DRILL BIT	235
I	
ICONOCLAST DISSECTOR	163
IMPROVED MALTZ RASP	183
INDO BOX ROUND	429
INDO BOX WITH SILVER FRAME	427
INGE LAMINA SPREADER	237
INGE RETRACTOR	236,237
INITIAL INCISION RETRACTOR	160
INSERT DRILL SLEEVE	231
INSTRUMENT BOILER	426
INSTRUMENT BOILER ELECTRIC	426
INSTRUMENT BOILER WITH STAND	426
INSTRUMENT BOX	425
INSTRUMENT TRAY	425
INSTRUMENT TRAY WITH COVER	425
INSTRUMENT TRAY WITHOUT COVER	427
INSTRUMENTS CASSETTE 5, 7, 10 PIECES CASSETTE	431
INSTRUMENTS FOR CRANIAL OPENING	238
INTESTINAL & TISSUE GRASPING FORCEPS	338,339,340,341,342,353
INTESTINAL CLAMPS	343,344,346,349
INTESTINAL RECTAL SPECULA	350,351,352,354
INTRA ORAL RETRACTOR	175
INTRACARDIAC NEEDLE HOLDERS	106
INTRACARDIAC NEEDLE HOLDERS T.C	111
IOL HOLDING FORCEPS	288
IOWA TENACULUM FORCEPS	386
IOWA, SUCTION TUBE	20
IRIS FORCEPS	63
IRIS SCISSORS	40,288
IRIS SKIN HOOKS	395
IRIS SUPER CUT SCISSORS	55
IRIS TISSUE FORCEPS	63
IUP GRASPING FORCEPS	392
IVES-FANSLER ANOSCOPE INTESTINAL RECTAL SPECULUM	352
IVES-FANSLER RECTAL SPECULUM	350
J	
JABOMA MICRO NEEDLE HOLDER	119
JACKSON BURROWS RETRACTOR	157
JACKSON INTERVERTEBRAL DISC RONGEURS	249
JACKSON LARYNGEAL FORCEPS	329
JACKSON RETRACTOR	373
JACKSON-BURROWS TISSUE & DRESSING FORCEPS	66
JACOB'S CHUCK	229
JACOBS	229
JACOBS UTERINE VULSELLUM FORCEPS	385
JACOBSON NEEDLE HOLDERS	103
JACOBSON NEEDLE HOLDERS T.C	112,119
JACOBSON NEURO-MICRO DISSECTOR	245
JAEGER EYE KNIVES	293
JAEGER LID PLATE	293
JAMESON CALIPER CHROME	294
JAMESON CALIPER	13
JAMESON NEEDLE HOLDERS	102
JANSEN BONE RONGEUR	212
JANSEN CURETTE	199
JANSEN DRESSING FORCEPS	318
JANSEN EAR CURETTE	308
JANSEN FORCEPS	68
JANSEN RETRACTOR	152
JARVIS PILE FORCEPS	383
JASEN BONE RONGEUR	212
JEFFERSON TISSUE & DRESSING FORCEPS	70
JENNINGS MOUTH GAG	326
JEWELER TYPE, DISSECTING FORCEPS	73
JOHNS-HOPKINS (POTTS MODIF.) RIB CONTRACTORS	277
JOHNSON NEEDLE HOLDERS	106
JOHNSON PROSTATIC NEEDLE HOLDER	359
JOLL (FRIEDMAN) THYROID- AND VEGINAL RETRACTOR	157
JOLL THYROID SELF RETAINING FORCEPS	392
JONES / PERFORATING TOWEL FORCEPS	93
JONES-MARTIN TOWEL CLAMP	93
JOPSON-HORNE COTTON APPLICATOR	22
JOSEPH BONE SAW / RASP	182
JOSEPH MASING SEPTUM RASPARTORY	165
JOSEPH NASAL KNIFE	309
JOSEPH NASAL SAW	172,313
JOSEPH OPERATING SCISSORS T/C INSERT	59
JOSEPH OPERATING, DISSECTING SCISSORS	39
JOSEPH RASP	313
JOSEPH SEPTUM ELEVATORS RASPARTORY	311
JOSEPH-MASING SEPTUM ELEVATORS RASPARTORY	311
JUDD MASSON BLADDER RETRACTOR	366
JUDD-ALLIS TISSUE FORCEPS	338
JULIAN NEEDLE HOLDERS T.C	117
JURASZ LARYNGEAL POLYPUD FORCEPS	337
K	
KALLMORGEN & RETRACTOR	374

DESCRIPTION	PAGE#
KALLMORGEN SPECULUM	374
KALLMORGEN SPECULUM & RETRACTOR	374
KALT NEEDLE HOLDERS	110,289
KALT NEEDLE HOLDERS T/C	120
KANADISCHES MODELL MENISCOTOMY KNIFE	205
KANE OBSTETRICAL FORCEPS	404
KAYE #3RK ROUND SCALPEL HANDLE	25
KAYE-MILLARD RETRACTOR	147
KEITH ABDOMINAL NEEDLE	125
KELLY HAEMOSTATIC FORCEPS	79
KELLY INTESTINAL RECTAL SPECULUM	351
KELLY OPERATING DISSECTING SCISSORS T/C INSERT	58
KELLY OPERATING, DISSECTING SCISSORS	39
KELLY PROCTOSCOPE INTESTINAL RECTAL SPECULUM	352
KELLY RETRACTORS	145,148,149
KELLY SPONGE & DRESSING FORCEPS	100
KERN BONE HOLDING FORCEPS	223
KERRISON BONE EAR RONGEURS	321
KERRISON CERVICAL RONGEUR	253
KERRISON RONGEUR	255,256,257,258
KEVORKIAN BIOPSY AND SPECIMEN FORCEPS	380
KEVORKIAN ENDOCERVICAL CURETTES	398,399
KEVORKIAN FLUSHING CURETTES	398
KEVORKIAN YOUNG BIOPSY FORCEPS	381
KEY HANDLE	229
KEY HERNIA DIRECTOR	367
KEY PERIOSTEAL ELEVATOR	203,204
KIDNEY STONE FORCEPS	355,356,357
KIDNEY TRAY (GERMAN PATTERN)	428
KIDNEY TRAY WITH COVER	428
KIELLAND OBSTETRICAL FORCEPS	408
KIELLAND-LUIKART OBSTETRICAL FORCEPS	408
KILIAN, SEPTUM GOUGE	187
KILIAN-CLAUS SEPTUM GOUGE	187
KILLIAN LARYNGETOMY SCISSORS	323
KILLIAN NASAL SPECULUM	304
KILLIAN NASAL SPECULUM WITH FIBER	172
KILLIAN NASAL SPECULUM WITH FIBER OPTICS ILLUMINATION	174
KILLIAN PROBES	23
KILLIAN SEPTUM ELEVATOR	165
KILLIAN SEPTUM SPECULUM	305
KILLIAN, EUSTACHIAN CATHETERS	20
KILNER HOOK	127
KILNER NEEDLE HOLDERS	105
KILNER NEEDLE HOLDERS T/C	112
KILNER-DOUGHTY MOUTH GAG	327
KILNER-DOUGHTY MOUTH GAG HANDLE	327
KILNER-DOUGHTY MOUTH GAG SET WITH 3 BLADES COMPLETE	327
KIRK MALLETS	191
KIRSCHNER EXTENSION BOWS	233
KIRSCHNER RETRACTOR	161
KIRSCHNER WIRES & STEINMANN PINS CUTTER	219
KIRSCHNER WIRES	233
KIRSCHNER-BALFOUR RETRACTOR	161
KISTLER EAR CARTILAGE RASP	183
KLAPP RETRACTOR	135
KLEINERT KUTZ ELEVATOR AND DISSECTOR	199
KLEINERT-KUTZ BONE CUTTING FORCEPS	218
KLEINERT-KUTZ BONE RASP	183
KLEINERT-KUTZ BONE RONGEUR	216
KLEINERT-KUTZ SYNOVECTOMY RONGEUR	218
KLEINERT-KUTZ TENDON RETRIEVER	206
KLINIKUM BERLIN TUBING CLAMP	94
KNIFE HANDLE (SMOOTH) FOR BLADES NOS. 60 AND 70	24
KNIGHT NASAL POLYPUS AND SEPTUM FORCEPS	317
KNOWLES PLASTER SCISSORS	52
KNUTSON URETHROGRAPHIE-INSTRUMENTS	364
KOCHER GOITRE ENUCLEATOR	330
KOCHER HAEMOSTATIC FORCEPS	83
KOCHER HAEMOSTATIC FORCEPS STRONG PATTERN	82
KOCHER HOOKLET, RETRACTORS	130
KOCHER INTESTINAL FORCEPS CLAMPS	343,344
KOCHER RETRACTOR	133,134,136
KOCHER-LANGENBECK RETRACTOR	137
KOCHER-OCHSNER HAEMOSTATIC FORCEPS	84
KOCHER'S BLADDER RETRACTOR	367
KOCHER-WAGNER RETRACTOR	136
KOERTE RETRACTOR	134,135
KOGAN - MODIF. SPECULUM	372
KOGAN ENDOCERVICAL SPATULA	372
KOGAN SPECULUM	372
KOLBEL SOFT TISSUE RETRACTOR	155
KOMPLETT	01
KONIG ELEVATOR	202
KONIG RETRACTOR	132
KONIG REVERDIN NEEDLES	122
KORTE-WAGNER RETRACTOR	134
KOTZUR CANNULAS	414
KRAATZ - BARRAQUER WIRE SPECULUM	294
KRAUS -VOSSE NASAL POLYPOUS SNARES	301
KRAUS -WILDE NASAL POLYPOUS SNARES	301
KRAUSE EAR POLYPOUS SNARES	301
KRAUSE NASAL POLYPOUS SNARES	301
KRAUSE, TROCER	15
KRISTELLER SPECULUM	373
KRISTELLER RETRACTOR	373
KRISTELLER SPECULUM & RETRACTOR	373
KRISTELLER SPECULUM TAPERED, FOR VIRGINS	373

DESCRIPTION	PAGE#
KRONECKER NEEDLE	123
KUEHNE CILIA FORCEPS	74
K-WIRE EXTRACTION PLIERS	210
L	
LA FORCE ADENOTOME PERFORATED	316
LA FORCE ADENOTOME UNPERFORATED	316
LABORDE TRACHEA DILATOR 3 PRONG	331
LACHRYMAL DILATOR	292
LACHRYMAL PROBES	292
LAHEY (SWEET) HAEMOSTATIC FORCEPS	87
LAHEY GOITER RETRACTOR	135
LAHEY GOITRE GRASPING FORCEPS	330
LAHEY NERVE DURA HOOK RETRACTOR	243
LAHEY RETRACTOR	135
LAMBERT-LOWMAN BONE CLAMP	221
LAMBOTTE BONE HOLDING FORCEPS	224
LAMBOTTE ELEVATOR	201
LAMBOTTE OSTEOTOME	187
LAMBOTTE RETRACTORS	131
LAMINECTOMY PUNCHES	247,248,249,250,251,252,253,254,255,256,257,258,259,260
LAMINECTOMY RETRACTORS	152
LANCASTER EYE SPECULUM	151
LANCET TIP	20
LANDAU SPECULUM	375
LANDAU, TROCER	15
LANDOLT DISSECTING SUCTION TUBES	17
LANDOLT FORCEPS	69
LANDOLT OPERATING	35
LANDON VAGINAL RETRACTOR	374,375
LANE BONE ELEVATOR	204
LANE BONE HOLDING FORCEPS	224
LANE BONE LEVER	207
LANE BONE PLATE HOLDING FORCEPS	225
LANE STOMACH INTESTINAL CLAMP FORCEPS	346
LANE TISSUE FORCEPS	64
LANE TISSUE GRASPING FORCEPS	342
LANGE BANDAGE SCISSORS	75
LANGE TISSUE FORCEPS	75
LANGENBECK AMPUTATION	30
LANGENBECK BONE ELEVATOR	164
LANGENBECK BONE HOLDING FORCEPS	223
LANGENBECK DISSECTING KNIVES	30
LANGENBECK EAR CURETTE	308
LANGENBECK METACARPAL SAW	182
LANGENBECK NEEDLE HOLDERS T/C	121
LANGENBECK PERIOSTEAL ELEVATOR	202
LANGENBECK PERIOSTEAL ELEVATOR	203,204
LANGENBECK POLYOUS GRASPING FORCEPS	383
LANGENBECK RETRACTOR	137,138
LARGE PIN CUTTER	220
LARRY PROBE AND GROOVED DIRECTOR	21
LARYNGEAL MIRRORS	330
LARYNGEAL MIRRORS HANDLE	330
LARYNGEAL MIRRORS WITH HANDLE	330
LARYNGEAL POLYPUD FORCEPS	337
LARYNGOSCOPE BATTERY HANDLE FOR	05
LARYNGOSCOPE BATTERY HANDLE FOR ADULT	03,04
LARYNGOSCOPE BATTERY HANDLE FOR ADULT AA BATTERIES	06
LARYNGOSCOPE BATTERY HANDLE FOR ADULT C TYPE	05
LARYNGOSCOPE FLEXIBLE (MC-COY) CONVENTIONAL SET	06
LARYNGOSCOPE SET OF CONVENTIONAL MILLER	05
LARYNGOSCOPES	03,04,05,06
LASTER-BURCH SPECULUM	294
LATERAL VAGINAL RETRACTOR	371
LATERAL VAGINAL RETRACTOR BLUE COATED LEEP / LIETZ	371
LATERALWALL RETRACTOR	371
LATHBURY-FARREL TRIANGULAR SERRATED END	23
LEAD HAND	209
LEBSCHER STERNUM CHISEL	283
LEECHWILKINSON BIOPSY FORCEPS	381
LEECHWILKINSON SUCTION BIOPSY CURETTES	398
LEEDHAM TISSUE FORCEPS	63
LEGUEU BLADDER RETRACTOR	367
LEGUEU BLADDER SPATULA	366
LEGUEU RETRACTOR	160
LEKSELL BONE RONGEUR	214,216
LEKSELL RONGEUR	214
LEKSELL-STILLE BONE RONGEUR	215
LELAND-JONES PERIPHERAL VASCULAR CLAMPS	269
LEMPERT BONE CURETTE	197
LEMPERT BONE RONGEUR	212
LEMPERT SEPTUM ELEVATORS RASPARTORY	311
LENS MANIPULATING HOOK	293
LENSE EXPRESSOR	292
LERCHE TISSUE FORCEPS	62
LESTER RETRACTOR	176
LEUR NEEDLE EXTENSIONS	393
LEVASSEUR MERRILL FIBER	175
LEWIN PERFORATING BONE HOLDING FORCEPS	222
LEWIS TONSIL SCREW	313
LEWKOWITZ LITHOTOMY FORCEPS	365
LEXER CHISEL	185
LEXER GOUGE	186,185
LEXER GOUGE TUFFNEL HANDLE	186
LEXER MODIF. CHISEL	185
LEXER MODIF. OSTEOTOME	185

DESCRIPTION	PAGE#
LEXER OPERATING SUPER CUT SCISSORS	55
LEXER OSTEOTOME	185
LEXER OSTEOTOME FLAT	186
LEYLA SELF-RETAINING BRAIN RETRACTOR	239,262
L-G INTERVERTEBRAL DISC RONGEURS	248
LICHTENBERG NEEDLE HOLDER	118
LICHTENBERG NEEDLE HOLDERS T.C	121
LICHTWITZ ANTRUM TROCAR	15
LIEBERMAN SPECULUM	294
LIGATOR RUBBER RINGS IN PACKAGE OF 100 PIECES	353
LIGATURE NEEDLE	123
LIGATURE REVERDIN NEEDLES	122
LIGATUR NEEDLES	124
LINDERMAN AMPUTATION SAW	182
LINK RONGEUR	259
LINK SIMPLECLEAN KERRISON RONGEUR	260
LINK-BEATTY RONGEUR	259
LIPOUSUCTION CANNULA SET	419,420,421
LIPOUSUCTION CANNULA SET FOR NECK	420
LIPOUSUCTION CANNULAS	410,411,412,414,415,416,417,418,419,40,421,422
LISTER BANDAGE PLASTER SCISSORS	51
LISTER BANDAGE PLASTER SCISSORS, T/C INSERT	59
LISTER BOUGIES	362
LISTER SINUS FORCEPS	95
LISTER-EXCENTRIC PLASTER SCISSORS	51
LISTON BONE CUTTING RONGEUR FORCEPS	216,217,218
LISTON DISSECTING KNIVES	30
LISTON KEY HORSLEY BONE CUTTING RONGEUR FORCEPS	217
LISTON-STILLE BONE CUTTING RONGEUR FORCEPS	218
LITTAUER / LISTON BONE CUTTING RONGEUR FORCEPS	216
LITTAUER CILIA FORCEPS	74
LITTAUER EAR POLYPUS FORCEPS	318
LITTAUER NASAL POLYPUS AND SEPTUM FORCEPS	317
LITTAUER STITCH SCISSORS	43
LITTLE RETRACTOR	135
LITTLE WOOD TISSUE GRASPING FORCEPS	342
LOCKE PHALANGEAL FORCEPS	222
LOCKHART-MUMMERY DIRECTORS	21
LOCKING PLIER	211
LOCKLIN DISSECTING SCISSORS	42
LOCKWOOD GRASP FORCEPS	341
LONG ANTERIOR KERRISON LAMINECTOMY PUNCH	261
LONG CHROME HANDLE INTESTINAL RECTAL SPECULUM	352
LONG HAEMOSTATIC TISSUE FORCEPS	89
LONGE OPERATING DISSECTING SCISSORS	35
LOPEZ-REINKE SUCTION TUBES	17
LORENZ PLASTER SCISSORS	52
LORNA TOWEL FORCEPS	93
LOVE NERVE DURA HOOK RETRACTOR	243
LOVE-GRUENWALD INTERVERTEBRAL DISC RONGEURS	247,248
LOVELACE LUNG TISSUE FORCEPS	341
LOWER HAEMOSTATIC FORCEPS	87
LOWMANN BONE CLAMP	221
LUBET-BARBON NASAL POLYPUS AND SEPTUM FORCEPS	317
LUC NASAL CUTTING FORCEPS	319
LUCAE / ENT DRESSING FORCEPS	67
LUCAE DRESSING FORCEPS	318
LUCAE EAR LOOPS - HOOKS	308
LUCAE HOOKLET & SKIN HOOKS	128
LUCAE MALLETS	191
LUCAE TISSUE & DRESSING FORCEPS	67
LUCAE TUNING FORK	299
LUCAS CHISEL	184
LUCAS CURETTE	199
LUCAS GOUGE	184
LUER BONE RONGEUR	211
LUER LOCK ADAPTER	14
LUER RETRACTOR	139
LUER SUCTION TUBE WORKING	19
LUER, TROCAR	14
LUER-KOERTE MODIF WITH MALLEABLE SHAFT	361
LUER-LOCK SUCTION & IRRIGATION CANNULA	19
LUER-STANDARD TRACHEA TUBES	331
LUER-STILLE BONE RONGEUR	215
LUETHY-BECK NEEDLE HOLDERS T.C	121
LUNG SPATULAS, AORTIC DILATORS	278
LUNIATSCHEK TONSIL TAMPON PLUGGER	313
LURE POLYOUS GRASPING FORCEPS	383
LURZ HEMORRHOUDAL SUCTION LIGATOR	353
M	
MACCOLLUM DINGMAN BREAST DISSECTOR	162,163
MACCOLLUM DINGMAN SUBMAMMARY DISSECTOR	162
MACPHAIL NEEDLE HOLDERS	108
MAGILL CATHETER INTUBATING FORCEP GOLD	01
MAGILL CATHETER INTUBATING FORCEPS	01
MAGILL SUCTION TUBE	20
MAINGOT UTERUS HOLDING FORCEPS	387
MALE CATHETERS CHARR, METAL	362
MALINIAC NASAL RETRACTOR WITH FIBER OPTIC	177
MALLEABLE RETRACTOR	150
MALLEOLLAR BONE HOLDING FORCEPS	227
MALLET #49	192
MALLETS	191,192,193
MALLET, LIGHTWEIGHT	192
MALONEY INTRA-OPERATIVE KERATOMETER TITANIUM	294
MALTZ NASAL SAW	314
MALTZ RASP	183,313

DESCRIPTION	PAGE#
MANDIBULAR CHANNEL RETRACTOR	174
MANNERFELT HOOK	128
MANNERFELT HOOKLET RETRACTORS	133
MANNERFELT MODIF. BALLENGER	187
MANNERFELT-LANGENBECK HOOK	128
MARBACH PLASTER SCISSORS	53
MARKHAM/MEYERDING RETRACTOR	152
MARKWALDER BONE CUTTING RONGEUR FORCEPS	217
MARQUARDT BONE RONGEUR	213
MARSCHIK TONSIL SEIZING FORCEPS	329
MARTEL HAEMOSTATIC FORCEPS	95
MARTIN CARTILAGE BONE HOLDING CLAMP FORCEPS	225
MARTIN NEEDLE HOLDER	118
MARTIN NERVE ROOT RETRACTOR	242
MARTIN PELVIMETER, OBSTETRICAL FORCEPS	406
MARTIN TONGUE SPATULA	325
MARTIN UTERINE SOUND	394
MARTIN VAGINAL SPECULA	378
MARTINI CURETTE	198
MARX BREAST RETRACTOR	166
MASING PERIOSTEAL SEPTUM ELEVATORS	312
MASING SEPTUM ELEVATOR	165
MASS. GENERAL HOSPITAL NEEDLE HOLDERS	103
MASSON NEEDLE HOLDER	106
MASSON NEEDLE HOLDERS T.C	118
MASSON-LUETHY NEEDLE HOLDERS	104
MASTIN GOITRE GRASPING FORCEPS	330
MATHIEU FOR CHILDREN AND VIRGINS	375
MATHIEU FOR CHILDREN AND VIRGINS FITTING	375
MATHIEU NEEDLE HOLDER T.C	120
MATHIEU NEEDLE HOLDERS	108
MATHIEU RECTAL SPECULUM	350
MATHIEU RETRACTOR	139
MATHIEU VAGINAL RETRACTOR	374
MATHIEU VAGINAL SPECULUM	374
MATHIEU-RYDER NEEDLE HOLDERS T.C	120
MATHIEU-RYDER VASCULAR NEEDLE HOLDERS T.C	120
MATSON MENISCOTOMY KNIFE	205
MAUNDER MOUTH GAG	326
MAURER-COLLIN RIB SHEARS	284
MAYFIELD BONE RONGEUR	214
MAYO DISSECTING & GYNECOLOGICAL SCISSORS	36
MAYO DISSECTING & GYNECOLOGICAL SCISSORS T/C INSERT	58
MAYO ROCHESTER NEEDLE HOLDERS	108
MAYO SCISSORS, SUPERCUT PLUS T.C.	170
MAYO UTERINE SOUND	394
MAYO VESSEL CLAMP	343
MAYO-BLAKE GALL STONE FORCEPS	358
MAYO-COLLIN RETRACTOR	141
MAYO-HARRINGTON DISSECTING & GYNECOLOGICAL SCISSORS	36
MAYO-HEGAR NEEDLE HOLDERS	101
MAYO-HEGAR NEEDLE HOLDERS T.C	113
MAYO-NOBLE DISSECTING & GYNECOLOGICAL SCISSORS	36
MAYO-ROBSON INTESTINAL CLAMP	344
MAYO-ROBSON INTESTINAL FORCEPS CLAMPS	343
MAYO-STILLE DISSECTING & GYNECOLOGICAL SCISSORS	36
MAYO-STILLE DISSECTING & GYNECOLOGICAL SCISSORS T/C INSERT	58
MC DONALD ELEVATORS	200
MC INDOE BONE CUTTING FORCEPS	218
MC INDOE BONE CUTTING RONGEUR FORCEPS	218
MC INDOE DRESSING FORCEPS	65
MC INDOE DRESSING FORCEPS T.C	78
MC GEE LATERAL VAGINAL RETRACTOR	371
MCGIVNEY HEMORRHOID GRASPING FORCEPS	353
MCGIVNEY HEMORRHOIDAL LIGATOR	353
MCGIVNEY HEMORRHOIDAL LIGATOR FORCEPS	354
MCINNIS POLYURETTE BREAST INSTRUMENT	163
MC-INTOSH FIBER OPTIC LARYNGOSCOPE BLADE	03
MC-INTOSH FIBER OPTIC LARYNGOSCOPE SET	03
MC-INTOSH FIBER OPTIC LARYNGOSCOPE SET HALOGEN ILLUMINATION	03
MC-INTOSH LARYNGOSCOPE	03,04,05
MC-INTOSH LARYNGOSCOPE CONVENTIONAL	05
MC-INTOSH LARYNGOSCOPE SET	03,04
MCKENZIE BRAIN CLIP RACK	240
MCKENZIE CLIP APPLYING FORCEPS	240
MCKENZIE HAND DRILL BIT	235
MCKENZIE INSTRUMENTS	240
MCLEAN OBSTETRICAL FORCEPS	408
MCLVOR MOUTH GAG COMPLETE SET	328
MCLVOR MOUTH GAG HANDLE	328
MCPHERSON - VANNAS	289
MCPHERSON FORCEPS	285,287
MCPHERSON NEEDLE HOLDER	289
MEAD BONE RONGEUR	213
MEAD Mallet	192
MEASURING GAUGE	234
MEASURING INSTRUMENTS	13
MEASURING JUG	429
MEDIAL RAMUS RETRACTOR	174
MEDICINE CUP GRADUATED	429
MEMORAL HEAD EXTRATOR	229
MENISCOTOMY KNIFE	205
MENISCUS CLAMP	222
MERCEDES CANNULAS	414
MESH BASKET	433
MESH CASSETTES 5 PIECES, 7 PIECES, 10 PIECES, 15PIECES & 20 PIECES	432
MESH TRAYS 05 PCS	432
MESH TRAYS 07 PCS	432

DESCRIPTION	PAGE#
MESH TRAYS 10 PCS	432
MESH TRAYS 20 PCS	432
MESH TRAYS	432
METZENBAUM NEEDLE HOLDERS	106
METZENBAUM OPERATING SCISSORS T/C INSERT	57
METZENBAUM OPERATING, DISSECTING SCISSORS	37
METZENBAUM-FINO OPERATING SCISSORS T/C INSERT	57
METZENBAUM-FINO SCISSORS	38
METZENBAUM-NELSON OPERATING SCISSORS T/C INSERT	57
METZENBAUM-NELSON SCISSORS	38
MEYERDING FINGER RETRACTOR	138
MEYERDING RETRACTOR	146,155,208
MICHEL CLIPS	76
MICHEL FORCEPS	76
MICHEL MOVEABLE MIRROR	330
MICHEL REVERDIN NEEDLES	122
MICHEL TISSUE FORCEPS	75
MICHELE TREPHINE	238
MICRO NEEDLE HOLDER	289
MICRO ADSON TISSUE & DRESSING FORCEPS T.C.	77
MICRO ADSON TISSUE FORCEPS T.C.	77
MICRO ALLIGATOR	334
MICRO ALLIGATOR SCISSORS	334
MICRO CUP FORCEPS	249
MICRO EJECTOR KERRISON LAMINECTOMY RONGEURS	251,253
MICRO FAT INJECTION CANNULAS SET	421
MICRO INSCISION FORCEPS	290
MICRO INSCISION SCISSORS	290
MICRO INSTRUMENTS FOR LARYNGO BRONCHO OESOPHAGOSCOPY	334,335,336
MICRO NEEDLE HOLDERS	110,119,288
MICRO NEEDLE TISSUE FORCEPS T.C.	78
MICRO RASP	183
MICRO RYDER NEEDLE HOLDERS	107
MICRO RYDER NEEDLE HOLDERS T.C.	111
MICRO SCISSORS	48,49,50,288
MICRO TYING FORCEPS	67
MICRO-ADSON TISSUE & DRESSING FORCEPS	70
MICRO-ADSON-BIEMER TISSUE & DRESSING FORCEPS	70
MICROVASCULAR NEEDLE HOLDERS	106
MICROVASCULAR NEEDLE HOLDERS T.C.	111
MIDDELORPF RETRACTOR	135
MIDDLETON-JANSEN SEPTUM FORCEPS	323
MIDFACE FACIAL DISSECTOR	163
MIKULICZ HAEMOSTATIC TISSUE FORCEPS	84,90
MIKULICZ RETRACTOR	145,146
MILLER ALVEOTOMY FILE	183
MILLER RASP	184
MILLER RETRACTOR	129
MILLER-COLBURN BONE FILE	183
MILLIGAN DURA DISSECTOR	242
MILLIGAN RETRACTOR	152
MILLIN BLADDER NECK SPREADER	365
MILLIN BLADDER RETRACTOR	366
MILLIN LIGATURE CARRYING FORCEPS ANGULAR	359
MILLIN PROSTECTOMY FORCEPS	359
MILLIN SUCTION TUBE	367
MILLIN VULSELLUM FORCEPS	359
MINI - NOVAK ASPIRATING CURETTE	397
MINI - TISCHLER BIOPSY AND SPECIMEN FORCEPS	380
MINI DRILL SLEEVE	230
MINI LEXER CHISEL	186
MINI LEXER OSTEOTOME	186
MINI NON ROTATING	241
MINI OPHTHALMOSCOPE	10
MINI ROTATING	241
MINI-HOHMANN BONE ELEVATOR	207
MINI-LAMBOTTE OSTEOTOME	187
MINI-ROUX RETRACTOR	140
MIXTER FORCEPS, LEE MODIF	88
MIXTER GALL STONE FORCEPS	358
MIXTER HAEMOSTATIC GALL DUCT FORCEPS	87
MIXTER-O'SHAUGNESSY HAEMOSTATIC FORCEPS	85
MOD. BONN SCISSORS	45
MOD. MARTIN DRESSING FORCEPS	61
MOD. MICHEL FORCEPS	76
MOD. USA. DRESSING FORCEPS	61
MOD. USA. TISSUE FORCEPS	61
MOD. WIEN NASAL SPECULUM	305
MODEL USA CAST SPREADER PLASTER	54
MODELL PICCOLO ROUND SERRATED	23
MODELL PICCOLO TRIANGULAR SERRATED END	23
MODIFIED-USA PLASTER SCISSORS	53
MÖELTGEN FLEXOMETER	
MOGEN CIRCUMCISION CLAMP	364
MOLLISON RETRACTOR	152
MOLT MOUTH GAG	326
MOORE DRILL AND BIT SET COMPLETE	228
MOREFELD FORCEPS	285
MORGEN PROCTOSCOPE INTESTINAL RECTAL SPECULUM	352
MORRIS RETRACTOR	149
MORSE STERNAL RETRACTOR	279
MORSE-FAVALORO STERNAL RETRACTOR	280
MORTISING CHISEL	230
MOSQUITO HAEMOSTATIC FORCEPS	79
MOUTH GAGS	326,327,328
MOUTH MIRRORS HEAD	06
MOYNIHAN GALL DUCT DILATOR	361
MOYNIHAN HAEMOSTATIC FORCEPS	83

DESCRIPTION	PAGE#
MULTI PURPOSE VASCULAR CLAMPS	272,273,274,276
MURPHY RETRACTORS	131
MUSEUX TENACULUM FORCEPS	385
MUSEUX TONSIL HOLDING FORCEPS	329
MYOMA INSTRUMENTS, FISTULA HOOKS	396
MYRTLE LEAF PROBE	23
N	
NABATOFF CABLE	263
NABATOFF HANDLE	263
NABATOFF METAL CASE	263
NABATOFF METAL OLIVE	263
NABATOFF METAL PROBE	263
NABATOFF PROBE TIP IN PLASTIC	263
NABATOFF VARICOSE VEIN STRIPPER	263
NAEGELE OBSTETRICAL FORCEPS	407
NAEGELE OBSTETRICS	404
NAGAHARA CHOPPER	292
NAGATA AURICULAR SEPTUM ELEVATOR	165
NAIL EXTRACTING FORCEPS	208
NAIL EXTRACTOR	
NAIL NIPPERS	47
NAIL RASP	183
NAIL SCISSORS	47
NAIL SPLITTING FORCEPS	209
NASAL CUTTING FORCEPS	320
NASAL KNIVES	309
NASAL POLYPUS & NASAL DRESSING FORCEPS	319
NASAL POLYPUS AND SEPTUM FORCEPS	317
NASAL POLYPUS SNARES	301
NASAL SAWS	313,314
NASAL SPECULA	302,303,304,305,306
NAUNTON MORGAN NEEDLE HOLDERS	103
NECK CANNULAS	413
NEEDLE HOLDER	287
NEEDLE CASE	427,429
NEEDLE HOLDERS (SCHWED. MODEL)	104
NEEDLE HOLDERS	101,102,104-121
NEEDLE NOSE PLIERS	209,210
NEEDLE-NOSE LOCKING PLIERS	211
NEFF MENISCOTOMY KNIFE	205
NEGUS HAEMOSTATIC FORCEPS	83
NEGUS MOUTH GAG HANDLE	327
NEGUS MOUTH GAG COMPLETE SET	327
NEIVERT NEEDLE HOLDERS	105
NEIVERT NEEDLE HOLDERS T.C.	117
NEIVERT-ANDERSON OSTEOTOME	189
NELATON DIRECTORS	21
NELATON PROBES & DIRECTORS	21
NELSON TISSUE FORCEPS	64
NELSON TROCER THORAX	14
NEONATAL VASCULAR CLAMPS	276
NERVE HOOKS - DURA HOOKS	243
NEUFELD HAMMER	191
NEURO-DUOFLEX HAMMER	02
NEURO-MICRO DISSECTORS	245,246
NEUTRAL & LOAD DRILL GUIDE	231
NEW INSTRUCTOR'S DISSECTING SET	11
NEW ORLEANS NEEDLE HOLDERS	103
NEW ORLEANS NEEDLE HOLDERS T.C.	111
NEW PORT RETRACTORS	371
NICHOLS WEIGHTED SPECULUM	378
NICHOLSVAGINALWEIGHTED SPECULUM	378
NO SCALPEL VASECTOMY HEMOSTAT FORCEPS	367
NO SCALPEL VASECTOMY RINGED FORCEPS CLAMPS	367
NOISE DRUM	299
NON-PERFORATING TOWEL FORCEPS	93
NORFOLK & NORWICH RETRACTOR	156
NORTHBENT STITCHES SCISSORS	43
NOSE PLIERS	210
NOSE SPECULUM	304
NOTO SPONGE & DRESSING FORCEPS	100
NOTT VIRGIN SPECULAUMS	370
NOVAK ASPIRATING CURETTE	397
NOVAK SUCTION	398
NOYES MICRO SCISSORS	50,287
NOYES NASAL DRESSING FORCEPS	319
NOYES SCISSORS	49
NUSSBAUM INTESTINAL FORCEPS CLAMPS	345
NUSSBAUM STOMACH INTESTINAL TWIN CLAMP FORCEPS	345
NYLON CAP	192
NYLON CAPS LEFT & RIGHT	192
NYLON HEAD MALLET	191
O	
O'BRIEN NEEDLE HOLDERS T.C.	118
O'BRIEN VASCULAR SCISSORS	82
O'SHAUGNESSY HAEMOSTATIC FORCEPS	42
O'SULLIVAN - O'CONNOR VAGINAL RETRACTOR	379
O'SULLIVAN/O'CONNOR RETRACTOR	159
OBSTETRICAL FORCEPS	407,408
OBSTETRICS	404
OBWEGESER - FREER	202
OBWEGESER ALVEOLAR (WISDOM TOOTH) RETRACTOR	173
OBWEGESER BLADE OSTEOTOME	190
OBWEGESER CHANNEL RETRACTOR	325
OBWEGESER CHEEK RETRACTOR	324
OBWEGESER CHIN RETRACTOR	174,325

DESCRIPTION	PAGE#
OBWEGESER ELEVATOR	199,202
OBWEGESER ILIAC CREST RETRACTOR	173
OBWEGESER MANDIBULAR CHANNEL RETRACTOR	174
OBWEGESER NASAL SPINE RETRACTOR	173,325
OBWEGESER NEEDLE	200
OBWEGESER OSTEOTOME	190
OBWEGESER RAMUS RETRACTOR	325
OBWEGESER RIB RASPIRATORY	165
OBWEGESER SOFT TISSUE RETRACTOR	325
OBWEGESER-FREER ELEVATOR	199
OCHSNER DRESSING FORCEPS	65
OCHSNER FORCEPS	75
OCHSNER TROCER THORAX	15
OCHSNER VASCULAR FORCEPS	266
OLDBERG INTERVERTEBRAL DISC RONGEURS	248
OLIVECRONA BRAIN SPATULA	241
OLIVECRONA DURA DISSECTOR	242
OLIVECRONA TOENNIS (SCOVILLE), CLIP FORCEPS	240
OLIVECRONA TRIGEMINAL KNIFE	31
OLIVECRONA VASCULAR SCISSORS	44
OLIVECRONA WIRE SAW	238
OLLIER RETRACTOR	135
OLSEN-HEGAR NEEDLE HOLDERS	104
OLSEN-HEGAR NEEDLE HOLDERS T.C	112
OMBREDANNE MALLETS	192
OPERATING & DISSECTING SCISSORS	35,37,38,39
OPERATING SCISSORS (FLAT PATTERN)	33
OPERATING SCISSORS	33,34,41
OPERATING SCISSORS T.C	56-59
OPERATING SCISSORS, B/B CVD, T/C INSERT	56
OPERATING SCISSORS, B/B STR. T/C INSERT	56
OPERATING SCISSORS, S/B STANDARD CVD, T/C INSERT	56
OPERATING SCISSORS, S/B STANDARD STR. T/C INSERT	56
OPERATING SCISSORS, S/S CVD, T/C INSERT	56
OPERATING SCISSORS, S/S STR. T/C INSERT	56
OPHTHALMOSCOPE	09
OPHTHALMOSCOPE HEAD	07,08
OPTIC RETRACTOR FOR VERTICAL OSTEOTOMIES	175
ORBITAL RIM DISSECTOR	164
ORINGER LIP AND CHEEK RETRACTOR	324
ORTHO MALLETS	192
ORTHOAEDICS, TENDON STRIPPERS	209
ORTHOPEDIC Mallet	192
OSTEOTOME BLADES, INTERCHANGEABLE	184
OSTEOTOME ELEVATOR	202
OSTEOTOMES	184,187
OTOSCOPE + OPHTHALMOSCOPE SET	10
OTOSCOPE HEAD	06,08
P	
PACKER MOSQUITO FORCEPS	81
PANTINGS BLADDER RETRACTOR	366
PAPER DRESSING FORCEPS	67
PARALLEL TARGET DEVICE	230
PARAMETRIUM FORCEPS, HYSTERECTOMY FORCEPS	388
PARAMETRIUM HAEMOSTATIC FORCEPS	89
PARAMETRIUM HYSTERECTOMY FORCEPS	388
PARHAM MARTIN BANDS	221
PARHAM-MARTIN BONE CLAMP	221
PARKER RETRACTOR	141
PARKER-LANGENBECK RETRACTOR	141
PARKER-MOTT RETRACTOR	141
PARTSCH CHISEL	184
PARTSCH GOUGE	185
PARTSCH MALLETS	191
PASSOW BONE TAMPER	194
PATELLA BONE SAW	183
PATELLA MALLEOLAR FORCEPS	227
PAUL HOOKLET RETRACTORS	129
PAYR CRUSHING INTESTINAL CLAMP	349
PAYR REVERDIN NEEDLES	122
PAYR-BABY CRUSHING INTESTINAL CLAMP	349
PEAN HAEMOSTATIC FORCEPS SLENDER TYPE	82
PEAPOD INTERVERTEBRAL DISC RONGEURS	254
PECK RAKE RETRACTOR	130
PEDERSON VAGINAL SPECULUM	369
PEDERSON VAGINAL SPECULUM LEEP / LIETZ	370
PEDERSON VIRGIN SPECULUMS	370
PEDIATRIC VASCULAR CLAMPS	275
PEERS-BERTMAN TOWEL FORCEPS	93
PEET SPLINTER FORCEPS	76
PELKMANN SPONGE FORCEPS	98,99
PELTESON COTTON APPLICATOR	22
PELVIC REDUCTION FORCEPS ASYMMETRIC	227
PELVIC REPOSITION FORCEPS	227
PELVIMETER, OBSTETRICAL FORCEPS	406
PENFIELD DURA DISSECTOR	245
PENFIELD ELEVATORS	200
PENN BREAST DISSECTOR	163
PENNINGTON / SIEZING HAEMOSTATIC FORCEPS	95
PENNINGTON SEPTUM ELEVATORS RASPIRATORY	311
PENNYBACKER PERIOSTEAL ELEVATOR	203
PERCUSSION HAMMERS	02
PERCY AMPUTATION SHIELD	182
PERFORATED BASKETS	433
PERFORATED TRAY	426
PERIOSTEAL ELEVATORS	164,199-204,207
PERIOSTEAL ELEVATORS, MENISCOTOMY KNIVES	205

DESCRIPTION	PAGE#
PERIOSTEAL ELEVATORS, SEPTUM ELEVATORS	312
PERIOSTEAL ELEVATORS, TAMPERS	194
PERIOSTEAL RASPIRATORIES	203
PERIOSTEAL SPREADER	164
PERIPHERAL VASCULAR CLAMPS	269,270
PERKINS RETRACTOR	154
PERTHES	230
PESTALOZZA OVUM CURETTE	405
PETRI PTERYGOID RETRACTOR WITH FIBER OPTIC	177
PHANEUF HAEMOSTATIC TISSUE FORCEPS	89
PHENOLIC HANDLE Mallet	192
PIERCE ANTRUM TROCER	15
PILER FORCEPS	383
PIN CUTTER MEDIUM	220
PIN CUTTER SMALL	220
PIN PULLER W/ GROOVE TC	219
PINARD ALUMINIUM STETHOSCOPE	01
PINARD WOODEN STETHOSCOPE	01
PIPER OBSTETRICAL FORCEPS	407
PLAIN FORCEPS	68
PLASTER SAW ELECTRONIC POWER	228
PLASTER SCISSORS	51-53
PLASTER SHEARS	54
PLASTIC EAR CANULAS	06
PLATE BENDER	232
PLATE BENDING PLIER	211
PLESTER DAUMENPLATT	18
PLESTER RETRACTOR	154
PLESTER SUCTION TUBES 17 CM	18
POLITZER EAR SPECULUM	295
POLYOUS GRASPING FORCEPS, ANASTOMOSIS	345,347,348,383
POOL SUCTION CANNULA	16
POTTS COARCTATION CLAMPS	267
POTTS LIGATURE FORCEPS	268
POTTS MULTI PURPOSE VASCULAR CLAMPS	272
POTTS MULTI PURPOSE VASCULAR CLAMPS	272
POTTS-SMITH DRESSING FORCEPS	61
POTTS-SMITH DRESSING FORCEPS T.C	78
POTTS-SMITH T.C DRESSING FORCEPS	78
POTTS-SMITH TISSUE FORCEPS	62
POTTS-SMITH VASCULAR SCISSORS	41
POZZI TENACULUM FORCEPS	386
PRATT ANTRUM CURETTE	310
PRATT HAEMOSTATIC FORCEPS	95
PRATT RECTAL SPECULUM	350
PRATT TENACULUM FORCEPS	385
PRATT UTERINE DILATORS 8/SET	389
PRATT UTERINE DILATORS, DOUBLE-ENDED	389
PRESBYTERIAN TUBING CLAMP	94
PRESTON LOGAMENTUM FLAVUM FORCEPS	222
PRINCE SCISSORS	45
PROBE MYRTLE-SHAPED	19
PROBE WITH EYE	19,23
PROBE, DOUBLE ENDED	19
PROBES AND DIRECTORS	21-23
PROFESSIONAL OTOSCOPE & OPHTHALMOLOGY SET	07
PROSTATIC RETRACTOR	360
PUNCH BRONCHO OESOPHAGOSCOPY FORCEPS	335
PUNCHES SPHENOID BONE	321
PUTTI RASP	182,183
PUTTI BONE FILE	182
PUTTI BONE RASP	182
Q	
QUERVAIN ELEVATOR	201
QUIRE EAR POLYPUS FORCEPS	318
R	
RABINER HAMMER	02
RAGNELL-DAVIS RETRACTOR	132
RALK DRILL	228
RAMATHIBODI TUBAL HOOK	372
RAMATHIBODI UTERINE MANIPULATOR	372
RAMSAY DISSECTING FORCEPS	64
RAMSAY TISSUE FORCEPS	64
RAMUS RETRACTOR	174
RANDALL KIDNEY STONE CLAMPS FORCEPS	355
RANDALL KIDNEY STONE FORCEPS	356
RANDALL SUCTION BIOPSY CURETTES	398
RANEY APPLIYG & REMOVING FORCEPS	240
RASPIRATORIES	186
RASPIRATORIES	186
RASPS WITH TUNGSTEN CARBIDE	313
RASPS, FILES	184
RAY BONE CURETTE	198
RAZOR BLADE BREAKER & HOLDER, STRAIGHT	26
RAZOR BLADE HOLDER & BREAKERS	26
RAZOR HOLLOW	32
RECAMIER UTERINE CURETTE	401,402
RECTAL BIOPSY FORCEPS	347
RECTUM VASECTOMY SET	368
RECTUM VASECTOMY SET OF 2 PCS	368
RECTUM VASECTOMY SET OF 3 PCS	368
RECTUM VASECTOMY SET OF 4 PCS	368
REDUCTION FORCEPS	227
REICHERT EPIGLOTIS RETRACTOR	323
REIL BONE HOLDING FORCEPS	227
REILL BONE REDUCTION FORCEPS	226

DESCRIPTION	PAGE#
REINER EAR SYRINGE	298
REINER EAR SYRINGE SHIELD	298
REPOSITION FORCEPS	227
REPROCUSSION FREE MALLET	193
RESANO DRESSING FORCEPS T.C	78
RESANO INTESTINAL POLYOUS GRASPING FORCEPS	345
RESECTION KNIFE	30
RETRACTOR, INSULATED BLADE	169
RETRACTORS & DRESSING FORCEPS	393
RETRACTORS	133-161,174-177,237,325,262,332,395
RETRACTORS INSTRUMENTS	173
RETRACTORS, VEIN HOOK	147
REUTHER LLIAC CREST RETRACTOR	176
REVERDIN NEEDLES	122,123,125,126
REVERDIN RETRACTOR	150
REYNOLDS OPERATING SCISSORS T/C INSERT	59
REYNOLDS TRANSAUXILLARY BREAST DISSECTOR, FENESTRATED,	162
RHEINSTADTER FLUSHING CURETTES	398
RHINOPLASTY INSTRUMENTS	178-181
RHINOPLASTY RETRACTORS	172
RHINOPLASTY SET	178-181
RIB CONTRACTORS	277
RIB RETRACTORS	279-282
RIB SHEAR	283
RIB SHEARS, STERNUM CHISEL	283,284
RIBBON RETRACTOR	150
RICHARDSON EASTMAN RETRACTOR	139
RICHARDSON RETRACTOR	148,149,176
RICHARDSON/KELLY RETRACTOR	147
RICHARDSON-EASTMAN RETRACTOR	149
RICHNAU HOLMGREN EAR SPECULUM	298
RICHTER OPERATING, DISSECTING SCISSORS	39
RICHTER-HEATH FORCEPS	76
RIECHERT SELF RETAINING BRAIN RETRACTOR	239
RIGHBY RETRACTOR	154
RING CUTTER	209
RINGMESSER	315,316
RISKIN BONE RONGEUR	214
RITTER-HALLE FORNTAL SINUS BOUGIES	322
ROBERTS HAEMOSTATIC FORCEPS	86
ROBINSON'S KNIFE	205
ROCHARD RETRACTOR	160
ROCHESTER NEEDLE HOLDERS T.C	114
ROCHESTER-CARMALT HAEMOSTATIC FORCEPS	83,84
ROCHESTER-OCHSNER HAEMOSTATIC FORCEPS	84
ROCHESTER-PEAN HAEMOSTATIC FORCEPS CURVED	84
ROCHESTER-PEAN HAEMOSTATIC FORCEPS STRAIGHT	84
ROD BENDER	232
ROEDER TOWEL FORCEPS	93
ROEGERS PARAMETRIUM HYSTERECTOMY FORCEPS	388
ROGGE STERILIZING FORCEPS	434
ROLLET (BLAIR) HOOKLET RETRACTORS	129
ROLLET HOOK	127
ROLLET HOOKLET RETRACTORS	129
ROOSEVELT STOMACH INTESTINAL TWIN CLAMP FORCEPS	346
ROSE RETRACTOR	139
ROSEN EAR SPECULUM	296
ROSEN PHCO SPLITTER	292
ROSEN SUCTION TUBE	20
ROSER-KONIG MOUTH GAG	326,328
ROSS RETRACTOR	147
ROTTGEN-RUSKIN BONE RONGEUR	215
ROTUNDA CATHERERS	393
ROUND BEDPAN	430
ROUND KNURLED SCALPEL HANDLE	25
ROUND SCALPEL HANDLE	26
ROUX RETRACTOR	140
ROUX-MAGNUS RETRACTOR	140
RUBIN OSTEOTOME	189
RUBIN SEPTAL MORSELIZER FORCEPS	170
RUBIN SEPTAL MORSELIZER FORCEPS T.C	170
RUBIN SEPTUM FORCEPS	323
RUBIO WIRE TWISTER NEEDLE HOLDERS T.C	117
RUSKIN BONE CUTTING RONGEUR FORCEPS	217
RUSKIN RONGEUR	214
RUSKIN-LISTON BONE CUTTING RONGEUR FORCEPS	218
RUSKIN-MINI BONE RONGEUR	216
RUSSIAN-MODELL TISSUE FORCEPS	65
RYDEL-SEIFFER TUNING FORK	299
RYDER FRENCH-EYE/STANDARD/MICRO NEEDLE HOLDERS T.C	115
RYDER NEEDLE HOLDERS	107
RYDER NEEDLE HOLDERS T.C	115
S	
SACHS DURA DISSECTOR	244
SACHS NERVE ELEVATOR	199
SAENGER ABORTION FORCEPS	405
SAFE CANNULA SET	422
SAFETY SUPER CUT SCISSORS	55
SAILER SCISSORS	44
SALDANHA SOLZ ABDOMINAL RETRACTOR	174
SALPINGOGRAPH	392
SAMII FORCEPS	67
SAROOT HAEMOSTATIC FORCEPS	81
SAROT NEEDLE HOLDERS	102,107
SAROT NEEDLE HOLDERS T.C	113
SATINSKY TANGENTIAL OCCLUSION FORCEPS	271
SATTERLEE AMPUTATION & RESECTION	32

DESCRIPTION	PAGE#
SATTERLEE SAW	182
SAUERBRUCH BONE RONGEUR	215
SAUERBRUCH RETRACTOR	142
SAUERBRUCH RIB SHEARS	284
SAUERBRUCH-FREY RIB SHEARS	283
SAW BLADE ONLY	209
SAWYER RETRACTORS	148
SAYRE PERIOSTEAL ELEVATOR	204
SCALER BOX	427
SCALER TRAY	427
SCALP ELEVATOR	164
SCALPEL #3P HANDLE	25
SCALPEL #3RC HANDLE	25
SCALPEL BLADES	27
SCALPEL GRIP	25
SCALPEL HANDLE #4 WITH ADJUSTABLE	25
SCALPEL HANDLE #4 WITH SCALE	24
SCALPEL HANDLE #7	24
SCALPEL HANDLE / LONG ANGLED #3LA	24
SCALPEL HANDLE 3L LONG	24
SCALPEL HANDLE 4L LONG BLADE	24
SCALPEL HANDLE 4LA	24
SCALPEL HANDLE DOUBLE ENDED #3, #4	24
SCALPEL HANDLE/ #3	24
SCALPEL HANDLE/ #4	24
SCALPEL HANDLES	24-26
SCALPEL KNIVES	28-29
SCALPEL PLASTIC HANDLE # 5	26
SCALPEL PLASTIC HANDLE # 6	26
SCALPEL PLASTIC HANDLE #8 BLADE	26
SCALPEL PLASTIC HANDLE	26
SCHAEDEL TOWEL FORCEPS	93
SCHAEDE BONE CURETTE	195
SCHAEDE ORGAN GRASPING FORCEPS	341
SCHERBACK SPECULUM	376
SCHINDLER HAEMOSTATIC TISSUE FORCEPS	88
SCHINK DERMATOMES	32
SCHLESINGER CERVICAL RONGEUR	253
SCHLESINGER INTERVERTEBRAL DISC RONGEURS	248
SCHMIEDEN NEEDLE	123
SCHMIEDEN-DICK NEEDLE	123
SCHOENBORE RETRACTOR	132
SCHRÖDER UTERINE SPOON	403
SCHROEDER BONE CURETTE	196
SCHROEDER FLUSHING CURETTES	398
SCHROEDER TENACULUM FORCEPS	386
SCHROEDER VULSELLUM TENACULUM FORCEPS	385
SCHROEDER-BRAUN TENACULUM FORCEPS	386
SCHUARDT RIB SHEARS	284
SCHUBERT BIOPSY FORCEPS	384
SCHUHKNECHT RETRACTOR	153
SCHULTZE, SALPINGOGRAPH	392
SCHULZE-BERGMANN INTESTINAL RECTAL SPECULUM	350
SCHUMACHER BIOPSY AND SPECIMEN FORCEPS	380
SCHUMACHER BIOPSY FORCEPS	380,384
SCHUMACHER PLASTER SCISSORS	53
SCHUMACHER RIB SHEARS	283
SCHUMACHER STERNUM SHEARS	220
SCHWARTZ CLIP APPLYING FORCEPS	240
SCHWARTZ VESSEL CLIP	240
SCHWARZ NASAL SPECULUM	304
SCHWENZER CHEEK RETRACTOR	176
SCISSORS	35,290
SCLERAL PLUG FORCEPS	286
SCOVILLE BONE CURETTE	197
SCOVILLE NERVE RETRACTOR	208
SCOVILLE, NERVE ROOT RETRACTOR	242
SCOVILLE-RICHTER RETRACTOR	159
SCREW DEPTH GAUGES	234
SCREW DRIVERS	230
SCUDDER INTESTINAL FORCEPS CLAMPS	345
SCULPO BREAST RETRACTORS	169
SEBILEAU PERIOSTEAL ELEVATOR	194
SEDLLOTT ELEVATOR	200
SEGOND MYOMA KNIFE	396
SEGOND MYOMATOME	31
SEGOND-LANDAU HAEMOSTATIC FORCEPS	88
SEIFFERT PROBES	23
SELETZ-GELPI RETRACTOR	153
SELF RETAINING BRAIN RETRACTOR	239
SELF-RETAINING RETRACTORS	286
SELLHEIM OBSTETRICAL LEVER	408
SELLORS RIB CONTRACTOR	277
SELVERSTONE INTERVERTEBRAL DISC RONGEURS	248
SEMB BONE CUTTING RONGEUR FORCEPS	217
SEMB BONE HOLDING FORCEPS	223,225
SEMB BONE RONGEUR	215
SEMB PERIOSTEAL ELEVATOR	202
SEMB RIB SHEARS	283
SEMKEN DRESSING FORCEPS	61
SEMKEN TISSUE FORCEPS	76
SEMM ABDOMINAL RETRACTORS	161
SEMM VAGINAL SPECULUM	369
SENN RETRACTOR	131
SENN-GREEN RETRACTOR	132
SENNING NEEDLE HOLDERS	104
SENNING NEEDLE HOLDERS T.C (SCHWED. MODEL)	111
SENN-MUELLER RETRACTOR	131

DESCRIPTION	PAGE#	DESCRIPTION	PAGE#
SEPTUM ELEVATORS - RASPARTORIES	311,324,325	STANDARD DRESSING FORCEPS	61
SEPTUM FORCEPS	323	STANDARD DRESSING FORCEPS NARROW POINT	61
SEPTUM INSTRUMENTS	322	STANDARD DRESSING FORCEPS SERRATED	61
SEPTUM NEEDLE SUCTION & IRRIGATION CANNULA	19	STANDARD DRESSING FORCEPS T.C	78
SEQUESTRUM (NIRCOSIS) BONE HOLDING FORCEPS	223	STANDARD NON ROTATING	241
SERRA GIGLI	182	STANDARD OPERATING SUPER CUT SCISSORS	55
SET SUGGESTIONS LIPOSUCTION CANNULAS	413	STANDARD OPHTHALMOSCOPE	10
SEUTIN PLASTER SCISSORS	53	STANDARD OPHTHALMOSCOPE SET	09
SEYFFERT VIRGIN SPECULAUMS	370	STANDARD OTOSCOPE + OPHTHALMOSCOPE SET	09
SHARMAN ENDOMETRIAL BIOPSY CURETTES	398	STANDARD OTOSCOPE SET	09
SHAVING MUG	430	STANDARD ROTATING	241
SHEA WITH FIBER OPTIC	175	STANDARD TISSUE FORCEPS	61
SHEEHAN OSTEOTOME	190	STAUDE - MOORE TENACULUM FORCEPS	386
SHORT REVERDIN NEEDLES	122	ST-CLAIR THOMSON NASAL SPECULUM	302
SHORTBENT STITCH SCISSORS	43	STELLBRINK BONE RONGEUR	212
SHOULDER PENETRATING GOUGE	187	STERILE SCALPEL BLADE SIZE # 10	27
SHOULDER PERCUSSION AWL	222	STERILE SCALPEL BLADE SIZE # 10A	27
SIDE CUTTER	220	STERILE SCALPEL BLADE SIZE # 11	27
SIDE PIN CUTTER	219	STERILE SCALPEL BLADE SIZE # 11P	27
SIDE WALL RETRACTORS	371	STERILE SCALPEL BLADE SIZE # 12	27
SIEGEL ROUND	25	STERILE SCALPEL BLADE SIZE # 13	27
SIEGEL ROUND SCALPEL HANDLE #3 WITH ADJUSTABLE	25	STERILE SCALPEL BLADE SIZE # 15	27
SIEGLE MAGNIFIER EAR SPECULUM COMPLETE SET	297	STERILE SCALPEL BLADE SIZE # 15A	27
SIEGLE MAGNIFIER OTOSCOPE	297	STERILE SCALPEL BLADE SIZE # 17	27
SIGMOID NPTCH RETRACTOR WITH FIBER OPTIC	177	STERILE SCALPEL BLADE SIZE # 18	27
SILVER DERMATOMES	32	STERILE SCALPEL BLADE SIZE # 20	27
SILVER RHINOPLASTIC CHISEL	189	STERILE SCALPEL BLADE SIZE # 21	27
SILVERSTEIN BREAST DISSECTOR	163	STERILE SCALPEL BLADE SIZE # 22	27
SIMON BONE CURETTE	196	STERILE SCALPEL BLADE SIZE # 23	27
SIMON DISSECTING KNIVES	30	STERILE SCALPEL BLADE SIZE # 24	27
SIMON FISTULA HOOK	396	STERILE SCALPEL BLADE SIZE # 25	27
SIMON VAGINAL RETRACTOR	374	STERILE SCALPEL BLADE SIZE # 36	27
SIMPSON - BRAUN OBSTETRICAL FORCEPS	407	STERILE SCALPEL BLADE SIZE # 40	27
SIMPSON - LUIKART OBSTETRICAL FORCEPS	407	STERILE SCALPEL BLADE SIZE # 6	27
SIMPSON OBSTETRICAL FORCEPS	407	STERILE SCALPEL BLADE SIZE # 60	27
SIMPSON UTERINE SOUND	394	STERILE SCALPEL BLADE SIZE # 70	27
SIMS DISSECTING & GYNECOLOGICAL SCISSORS	40	STERILE SCALPEL BLADE SIZE # E11	27
SIMS HANDLE	395	STERILIZING BOXES (WITH SILICON PADS)	291
SIMS RECTAL SPECULUM	350	STERILIZING DRUMS	424
SIMS SPECULUM & RETRACTOR	373	STERILIZING FORCEPS	434
SIMS UTERINE CURETTES	400,402	STERNBERG LIP AND CHEEK RETRACTOR	324
SIMS UTERINE SOUND	394	STERNBERG RETRACTOR	132
SIMS-MAIER SPONGE & DRESSING FORCEPS	98	STERNUM NEEDLE HOLDERS T.C	116
SIMS-SPECIAL UTERINE SOUND	394	STETHOSCOPES	01
SINGLEY-TUTTLE FORCEPS	65	STEVENS OPERATING SCISSORS T/C INSERT	59
SINSKEY HOOK	292	STEVENS SCISSORS	47
SINSKEY II LENS MANIPULATING HOOK	293	STEVENS TENOTOMY SUPER CUT SCISSORS	55
SINUSCOPY TROCAR	14	STEVENS TISSUE FORCEPS	72
SKENE TENACULUM FORCEPS	386	STIEGLITZ FORCEPS WITH MEGNIFYING MIRRORS	75
SKIN FIXING PLATE	32	STIEGLITZ SPLINTER FORCEPS	76
SLOTTED HAMMER	232	STILLE	185,188
SLUDER-BALLENGER TONSIL GUILLOTINES & PUNCH FORCEPS	316	STILLE BONE RONGEUR	214
SLUDER-BALLENGER TONSIL GUILLOTINES & PUNCH FORCEPS HANDLE	316	STILLE CHISEL	185,188
SMELLIE OBSTETRICAL FORCEPS	404	STILLE GOUGE	185,188
SMELLIE RETRACTORS	395	STILLE HAEMOSTATIC FORCEPS	87
SMILLIE MENISCOTOMY KNIFE	205	STILLE OSTEOTOME	185,188
SMITH (MOD. USA) PLASTER SCISSORS	52	STILLE PATTERN DRILL SET	228
SMITH PETERSON	185	STILLE PLASTER SHEARS	54,220
SMITH PETERSON OSTEOTOME	185	STILLE-BARRAYA TISSUE FORCEPS	65
SMITH-BLUE INTESTINAL RECTAL SPECULUM	350	STILLE-HORSLEY BONE CUTTING FORCEPS	218
SMITH-PETERSEN	188	STILLE-LEUR RONGEUR	215
SMITH-PETERSEN GOUGE	188	STILLE-LISTON BONE CUTTING RONGEUR FORCEPS	217,218
SMITH-PETERSEN OSTEOTOME	188	STILLE-LUER ECHLIN DUCKBILL RONGEUR	215
SMITH-PETERSON LAMINECTOMY RONGEUR	213	STILLE-LUER RONGEUR FORCEPS	214
SMITHWICH DURA DISSECTOR	244	STILLE-RUSKIN BONE RONGEUR	214
SMITHWICK CLIP APPLYING FORCEPS	240	STITCH SCISSORS	43
SMITHWICK NERVE DURA HOOK	242	STOCKMANN PENILE CLAMP	364
SOFIELD RETRACTOR	139	STONE TISSUE FORCEPS	62
SOLID COPPER HEAD MALLET	191	STONE-WATT CLOSING FORCEPS	342
SOLZ AREOLA MARKER	162	STONE-WATT INTESTINAL ANASTOMOSIS CLAMP	348
SOLZ ATRAUMATIC BREAST DISSECTOR	162	STRABISMUS HOOK	292
SOLZ BREAST HOOK DISSECTOR	162	STRANDELL-STILLE RETRACTOR	132
SOMER KIDNEY ELEVATING STONE CLAMPS FORCEPS	357	STRASSMANN KIDNEY ELEVATING STONE CLAMPS FORCEPS	357
SPARE BLADE	32	STRATTE NEEDLE HOLDERS	102,359
SPATULA	23	STRATTE NEEDLE HOLDERS T.C	114
SPATULA BREAST RETRACTOR DISSECTOR	163	STRAUSS PENILE CLAMP	365
SPECIMEN AND ASPIRATING CURETTE	397	STRUEMPFLER EAR FORCEPS	333
SPECULUMS & CALIPERS	294	SUBACROMION SPREADER	224
SPENCER CORONARY NEEDLE HOLDERS T.C	119	SUCTION AND IRRIGATION CANNULAS	19
SPENCER STITCH SCISSORS	43	SUCTION CANNULA FOR TONSILLECTOMY, ORAL	16
SPENCER-WELLS HAEMOSTATIC FORCEPS SLENDER TYPE	83	SUCTION ELEVATOR	164
SPINAL DISTRACTOR	236	SUCTION TUBE, GUIDE NEEDLE	20
SPINAL RASPARTORY	204	SUCTION TUBES	16-18
SPLINTER FORCEPS	74,75,76	SULLIVAN SCISSORS	45
SPLIT LAMP	428	SUPER CUT SCISSORS	55
SPRATT BONE CURETTE / HOLLOW HANDLE	195	SUPRA CUT DISTRACTION SCREW	237
SPREADER PLASTER	54	SUPRA CUT DISTRACTION SCREW DRIVER	237
SPRIT LAMP	429	SURGEONS NEEDLES	125,126
SPURLING KERRISON LAMINECTOMY RONGEURS	251	SUTURE RETRIEVAL HOOK	395
SPURLING INTERVERTEBRAL DISC RONGEURS	247,248,253	SUTURE TYING FORCEPS	285,287
SPURLING LAMINECTOMY RONGEURS	252,253	SWEDISH PATTERN DRESSING FORCEPS	65
SPUTUM MUG	430	SYPERT RONGEUR	216
S-SHAPED BLUNT CANNULA	16	SYSTRUNK SCISSORS	46
S-SHAPED RETRACTOR	144		
ST. CLAIR-THOMSON ADENOID CURETTE	315	T	
ST. THOMAS KNIFE	205	T.C OEHLER TISSUE FORCEPS	76
STACKE PROBES	23	TAKAHASHI NASAL CUTTING FORCEPS 3	19
STAGBEETLE BONE REDUCTION FORCEPS	222	TANGENTIAL OCCLUSION FORCEPS	271

DESCRIPTION	PAGE#
TAP SLEEVE	231
TARNIER OBSTETRICAL FORCEPS	408
TAY-BRONSON BONE CURETTE	197
TAYLOR HAMMER	02
TAYLOR RETRACTOR	208
TAYLOR SPINAL RETRACTORS	139
TEALE HERNIA DIRECTOR	367
TEALE TENACULUM FORCEPS	385
TEBBETTS BREAST AUGMENTATION FIBER OPTIC	169
TEBBETTS BREAST AUGMENTATION FIBER OPTIC RETRACTOR	168
TEBBETTS FIBER OPTIC RETRACTOR	168,169
TEBBETTS RETRACTOR	168
TECHNICAL FORCEPS	211
TEMPORAL T DISSECTOR	163
TENACULUM EMETT	395
TENACULUM FORCEPS	385,386
TENDON HOOKS RETRACTOR	135
TENDON SEIZING FORCEPS	99
TENDON STRIPPERS, BONE LEVERS	206
TENDON STRIPPERS, TECHNICAL FORCEPS	210
TENDON TUNELLING FORCEPS	209
TENNANT TYING FORCEPS	286
TENOTOMY, CAPSULOTOMY VANNAS SCISSORS	289
TESSIER RIB GRAFT RETRACTOR ADULT	176
T-HANDLE AO COUPLING	229
T-HANDLE FOR AO COUPLING	229
THIERSCH DERMATOMES	32
THIGH - LOWER LEG CANNULAS	413
THIN FOOTPLATE KERRISON LAMINECTOMY PUNCH	261
THOLE PELVIMETER, OBSTETRICAL FORCEPS	406
THOMS-ALLIS INTESTINAL AND TISSUE GRASPING FORCEPS	339
THOMS-GAYLOR BIOPSY FORCEPS	384
THOMSON WALKER BLADDER RETRACTOR	366
THOMSON WALKER NEEDLE HOLDERS	103
THOMSON WALKER PENILE CLAMP	365
THOMSON-WALKER NEEDLE HOLDERS T.C	118
THOMSON-WALKER'S PENILE CLAMPS	93
THORACIC & I.M.A RIB RETRACTORS	281
THORACIC RIB RETRACTORS	281
THORPE TISSUE & DRESSING FORCEPS	70
THUDICHUM (GOLDSMITH) NASAL SPECULUM	302,303
TIECK-HALLE NASAL SPECULUM	304
TILLEY NASAL POLYPUS AND SEPTUM FORCEPS	317
TISCHLER - MORGAN BIOPSY AND SPECIMEN FORCEPS	380
TISCHLER BABY BIOPSY FORCEPS	380
TISCHLER BIOPSY FORCEPS	381
TISSUE & DRESSING FORCEPS	61-72
TISSUE & DRESSING FORCEPS T.C	77
TISSUE FORCEPS	63,68,71
TOBOLD TONGUE DEPRESSOR	324
TOENNIS DURA DISSECTOR	244
TOENNIS HOOK & SKIN HOOK	127
TOENNIS NEEDLE HOLDERS	109
TOENNIS NEEDLE HOLDERS T.C	119
TOENNIS NERVE DURA HOOK	242
TOHOKU TOWEL FORCEPS	93
TOLEDO CANNULAS	414
TONGUE SPATULA	325
TONOMETER SET	
TONSIL INSTRUMENTS	302,318,329
TONSIL KNIFE	308
TONSIL KNIVES	308
TONSIL NEEDLE SUCTION & IRRIGATION CANNULA	19
TONSIL, NASAL SCISSORS	44
TOWEL FORCEPS	93
TOWNLEY CALIPER	13
TOYNEBEE EAR SPECULUM	295
TRACHEA DILATORS, TRACHEA TUBES	331
TRACHEAL RETRACTOR	129
TRACHEOTOMY BRONCHO-OESOPHAGOSCOPY FORCEPS SET	332
TRACHEOTOMY SET	332
TRANSORAL DISSECTOR	163
TRAUBE HAMMER	02
TRAUERS RETRACTOR	153
TRELAT ELEVATOR	201
TRELAT VAGINAL SPECULUM	369
TREHOWAN'S BONE ELEVATOR	204
TREVS TISSUE FORCEPS	62
TRIGEMINAL KNIFE	31
TROCAR	15
TROCAR BREAST TUBE	163
TROCARS	14-16
TROELTSCH DRESSING FORCEPS	318
TROELTSCH FORCEPS	69
TROEMNER HAMMER	02
TROEMNER-SIMPLEX HAMMER	02
TROELTSCH EUSTACHIAN CATHETERS	20
TROUSSEAU TRACHEA DILATOR 2 PRONG	331
TROUTMAN MICRO SCISSORS	49
TROUTMAN NEEDLE HOLDERS	109
TROUTMAN-CASTROVIEJO SCISSORS	290
TROUTMAN-CHRIS BLADE BREAKER & HOLDER ANGLED, WITH PUSH-PULL LOCK	26
TROUTMAN-CHRIS BLADE BREAKER & HOLDER WITH PUSH-PULL LOCK	26
TUBBS MITRAL VALVE AORTIC DILATOR	278
TUBING CLAMP	94
TUBING CLUMP WITH PROTECTOR	94
TUFFIER / HABERER RETRACTOR	150

DESCRIPTION	PAGE#
TUFFIER HAEMOSTATIC FORCEPS	95
TUFFIER RETRACTOR	145,146
TUFFIER RIB RETRACTORS	280,281
TUFFIER TISSUE FORCEPS	339
TUMARKIN EAR SPECULUM	296
TUNING FORKS	299,300
TUNING FORKS NEUROL WITH HAMMER	299
TUNING FORKS SET	300
TUPPERS HAND RETRACTOR SET	173
TURNBULL NIPPERS	47
TURNER-DOYEN RETRACTORS	148
TYDING TONSIL SNARE	302
U	
U.S. ARMY PATTERN	184
UCKERMANN TRACHEA TUBES	331
UCKERMANN TROCAR	14
UFFENORDE BONE CURETTE LEFT	195
UFFENORDE BONE CURETTE RIGHT	195
ULRICH BONE HOLDING FORCEPS	224
ULRICH BONE HOLDING SELF RETAINING FORCEPS	224
ULRICH SPONGE FORCEPS	98
UNI - BURKE BIOPSY AND SPECIMEN FORCEPS	382
UNI - KEVORKIAN BIOPSY AND SPECIMEN FORCEPS	382
UNI - OVAL BIOPSY AND SPECIMEN FORCEPS	382
UNI - RANDALL ASPIRATING CURETTE	397
UNI - RANDALL ASPIRATING CURETTE	397
UNI - TISCHLER BIOPSY AND SPECIMEN FORCEPS	382
UNI - TOWNSEND BIOPSY AND SPECIMEN FORCEPS	382
UNIVERSAL ABDOMINAL TROCAR SET	14
UNIVERSAL BONE RONGEUR	213
UNIVERSAL FAT INJECTION SYRINGE	423
UNIVERSAL HAMMER	192
UNIVERSAL OTOSCOPE & OPHTHALMOLOGY SET	08
UNIVERSAL PARAMEDIC SHEAR	60
UNIVERSAL ROD BENDER	232
UNIVERSAL SCISSORS	60
UNIVERSAL WIRE CUTTING SCISSORS	46
URETHRAL CATHETERS	362,363
URINAL - FEMALE	430
URINAL - MALE	430
URO-TANGENTIAL GALL STONE FORCEPS	358
USA MODELL SPECIMEN FORCEPS	380
US-ARMY RETRACTOR	139
UTERINE CURETTES	400-402
UTERINE DILATORS	389
UTERINE SCOOPS, SUCTION CURETTES & UTERINE DEPRESSOR	399
UTERINE SOUNDS	390,391,394
UTERINE SPOONS	403
UTERUS HOLDING FORCEPS	387
UTILITY STERILIZING FORCEPS	434
UTILITY TECHNICAL FORCEPS PLIERS	210
UTRATA CAPSULORHEXIS FORCEPS	285-287
V	
VACHER NASAL SPECULUM	298
VAGINAL DRESSING FORCEPS	393
VAGINAL SPECULA	369-379
VAGINAL SPECULA, VAGINAL RETRACTORS	374
VALLEIX UTERINE SOUND	394
VAN BUREN SEQUESTERUM FORCEPS	223
VAN BUREN URETHRAL SOUND	362
VAN DOREN BIOPSY FORCEPS	384
VANNAS SCISSORS	288,289
VARICOSE VEIN PROBE SET	263
VASCULAR FORCEPS	265,266
VASCULAR SCISSORS	41,42
VEBRUGGE SELF-CENTERING BONE HOLDING FORCEPS	225
VEBRUGGE BONE HOLDING FORCEPS	225,226
VERNIER CALIPER	13
VERNON-DAVID INTESTINAL RECTAL SPECULUM	351
VERONIKIS VAGINAL RETRACTORS	375
VESTIBULUM RETRACTOR	324
VICKERS MALLETS	193
VIENNA SPECULUM	304
VIRCHOW DISSECTING KNIVES	31
VITAL HEAVY DUTY PLIERS T.C	219
VITAL WIRE CUTTER	219
VITAL WIRE EXTRACTION PLIERS T.C	219
VITRECTOMY SCISSORS	290
VITREORETINAL FORCEPS	290
VOLKMAN RETRACTOR	131
VOLKMAN BONE CURETTE	195
VOLKMAN CURETTE	198
VOLKMAN RETRACTORS	131,134
VOLTOLINI NASAL SPECULUM	298
VON GRAEFE KNIFE	293
VON GRAEFE STRABISMUS & SKIN HOOKS	128
W	
WACHENFELDT TISSUE FORCEPS	75,76
WAGENER EAR LOOPS - HOOKS	308
WAGENER HOOKLET & SKIN HOOKS	128
WALB DISSECTING KNIVES	31
WALDMANN PLASTER SCISSORS	52
WALDMANN SCISSORS	53
WALLICH OVUM CURETTE	405
WALTER ALAR AND NASAL RETRACTOR	171
WALTER GOUGE	189

DESCRIPTION	PAGE#
WALTON-LISTON BONE CUTTING RONGEUR FORCEPS	218
WANGENSTEEN DRESSING FORCEPS	62
WANGENSTEEN DRESSING FORCEPS T.C.....	78
WANGENSTEEN NEEDLE HOLDERS	106
WANGENSTEEN NEEDLE HOLDERS T.C	113
WARTENBERG PINWHEEL	02
WASH BASIN	428
WASSMUND RETRACTOR	135
WATSON DERMATOMES	32
WATSON-CHEYNE ELEVATORS	200
WATSON-CHEYNE RASPATORY	312
WATSON-WILLIAMS NASAL CUTTING FORCEPS	319
WAUGH DRESSING FORCEPS	63
WAUGH TISSUE FORCEPS	63
WEBER AESTHESIOMETER	01
WEBSTER NEEDLE HOLDER	101
WEBSTER NEEDLE HOLDERS T.C	117
WECKER SCISSORS	49,290
WEIL NASAL CUTTING FORCEPS	319
WEIL-BLAKESLEY NASAL CUTTING FORCEPS	320
WEINBERG VAGOTOMY RETRACTOR (JOE'S HOE)	147
WEINGÄRTNER EAR FORCEPS	333
WEISSBARTH SPECULUM & RETRACTOR	377
WEITLANER RETRACTOR	154,155
WELL BLAKESLEY LAMINECTOMY RONGEURS	249
WELLENSCHLIFF NASAL SAW	182
WERTHEIM HAEMOSTATIC FORCEPS	92
WERTHEIM HAEMOSTATIC TISSUE FORCEPS	91
WERTHEIM HYSTERECTOMY FORCEPS	91
WERTHEIM NEEDLE HOLDERS	104
WERTHEIM NEEDLE HOLDERS T.C	112
WERTHEIM PARAMETRIUM CLAMPS	91
WERTHEIM RETRACTOR	375
WERTHEIM-CULLEN HAEMOSTATIC FORCEPS	92
WESTCOTT MICRO SCISSORS	49
WESTCOTT SCISSORS	288
WESTERMARK HAEMOSTATIC FORCEPS	89
WESTMACOTT NASAL POLYPUS AND SEPTUM FORCEPS	317
WHITE TONSIL SEIZING FORCEPS	329
WHITEHEAD MOUTH GAG	326
WHITTAKER TENACULUM 3 PRONG	395
WIDE MOUTH EJECTOR KERRISON LAMINECTOMY RONGEURS	251,253
WIEDER BREAST AND FACIAL RETRACTOR / TONGUE DEPRESSOR, SERRATED, ...	166
WIEDER BREAST AND FACIAL RETRACTOR / TONGUE DEPRESSOR, SERRATED.166	166
WIEDER TONGUE DEPRESSOR	316
WIENER HOOK & SKIN HOOK	127
WIENER NASAL SAW	314
WILDE FORCEPS	69
WILDE INTERVERTEBRAL DISC RONGEURS	248
WILDE NASAL DRESSING FORCEPS	318
WILDER LACRIMAL DILATOR	23
WILLET-MARTEL HAEMOSTATIC FORCEPS	95
WILLIAM LACRIMAL PROBES DOUBLE ENDED, STERLING SILVER	22
WILLIAM PROBE	22
WILLIAMS GRASP FORCEPS	338
WILLIAMS STYLE MICRO DISC INTERVERTEBRAL DISC RONGEURS	249
WILLIGER CURETTE	198,199
WILLIGER ELEVATOR	201
WILLIGER HAMMER	191
WILLIGER MALLETS	192
WINKELMANN CIRCUMCISION CLAMPS	364
WINTER ABORTION FORCEPS	405
WINTER TENACULUM FORCEPS	385
WINTERTON VAGINAL SPECULUM	369
WIRE BENDING FORCEPS	210
WIRE CUTTING INSTRUMENTS	219,220
WIRE CUTTING SCISSORS	46
WIRE CUTTING SCISSORS T/C INSERT	58
WIRE FORCEPS	220
WIRE GUIDE	230
WIRE INSTRUMENTS	232
WIRE RETAINING RETRACTOR	151
WIRE SPECULUMS	294
WIRE TIGHTENING NEEDLE HOLDERS T.C	117
WIRE TWISTERS NEEDLE HOLDERS T.C	116
WIRE VECTUS	292
WITH FIBER OPTIC ILLUMINATION	171
WITTNER BIOPSY AND SPECIMEN FORCEPS	380
WITTNER BIOPSY FORCEPS	380
WOLFF SPREADER PLASTER	54
WOODSON DURAL SEPARATOR/PACKER	200
WOODSON ELEVATOR/SPATULA	200
WRENCH KIRSCHNER EXTENSION BOWS	233
WRIGLEY OBSTETRICAL FORCEPS	407
WULLSTEIN RETRACTOR	153
WULLSTEIN SUCTION TUBE COMPLETE	17
Y	
YANCOSKIE RETRACTOR	177
YANKAUER NASAL SPECULUM	298
YANKAUER SUCTION TUBE	17
YASARGIL FORCEPS	68,69
YASARGIL NERVE DURA HOOK RETRACTOR	243
YASARGIL NEURO-MICRO DISSECTOR	246
YASARGILL SCISSORS	50
YEOMAN BIOPSY FORCEPS	335
YEOMANN INTESTINAL POLYOUS GRASPING FORCEPS	347

DESCRIPTION	PAGE#
YEOMANN POLYOUS GRASPING FORCEPS	383
YOUNG LOBE HOLDING FORCEPS	365
YOUNG NEEDLE	123
YOUNG PROSTATIC RETRACTOR	360
Z	
ZAUFAL-JANSEN BONE RONGEUR	213
ZIEGLER CLIA FORCEPS	74
ZIEGLER PROTECTION CAP	01
ZIESER MEAEUS CLAMP	365
ZIMMERMAN MYOTOME, CHISEL TIP	404
ZIMMERMAN MYOTOME, SPOON TIP	404
ZOLLNER EAR SPECULUM	296
ZÖLLNER, SUCTION TUBE	20
ZWEIFEL DOUBLE ENDED	399
ZWEIFEL NEEDLE HOLDERS T.C	121
ZYGOMATIC ARCH ELEVATOR	164

MANZIM
SURGICO

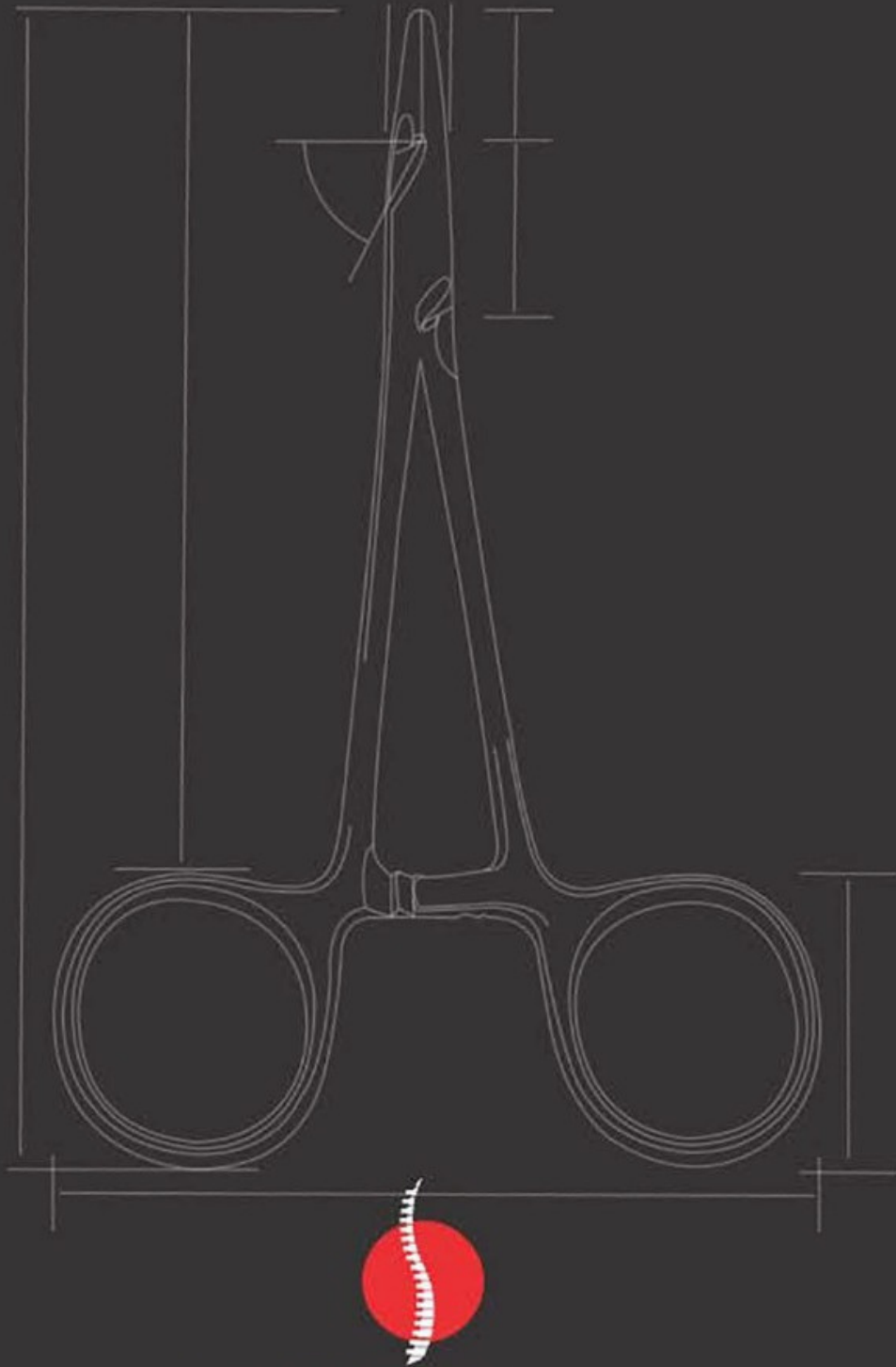

MANZIM SURGICO

We Are Manufacturer & Exporter of Surgical Instruments.

ADDRESS : R/CN 394 Near Islam Masjid Shatab Garh
P/o Small Industrial Estate Sialkot. 51310 Pakistan

TEL : 0092-52-3253436

FAX : 0092-52-3253436

MOBILE# 0092-300-5159397
0092-307-5311117

EMAIL : sales@manzimsurgico.com
info@manzimsurgico.com

WEB: www.manzimsurgico.com