

Gynecology/Obstetrics Instruments Catalogue

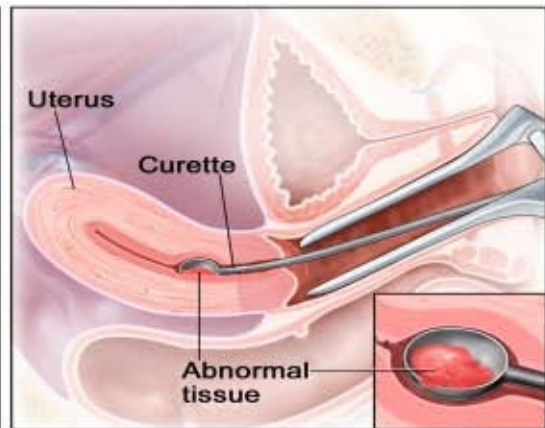

Dilatation and Curettage

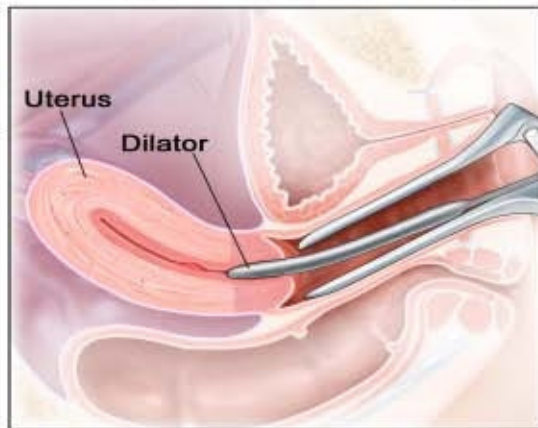
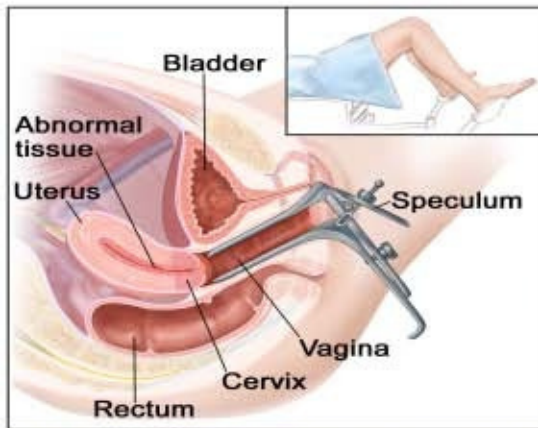

MANZIM SURGICO

Manufacturers & Exporters of Gynecology / Obstetrics Instruments.

Company Profile

Manzim surgico was founded over a quarter century ago to fill the need for old world craftsmanship, combined with our German technology and production know-how to achieve this unique combination of skills and instruments of the finest quality Manzim Surgico has devised and created New process, New quality control System .This concept has been building an enviable reputation in operating rooms throughout the world.

Products:

Manzim Surgico Strives to produce & Supply the latest and most comprehensive range of instruments, Due to rapid evolution in the field of biological science and constant revolution in surgical methodology,Manzim Surgico constantly review and update the product range with passage of time . All major production processes and performed in-house in production workshop.

Activity:

Manzim Surgico manufacture and Supply top quality Re-useable type and Single-use Gynecology/Obstetrics Instruments.

Quality Assurance:

Manzim Surgico prides itself on the rigorous quality control monitoring on every step from initial to final stage to ensure the supply of finest grade consistency instruments according to the required specifications supplied.

Certified Quality Awards:

Manzim Surgico's Production and quality comply with MD EEC 92/93 ,ISO 9001,ISO 13485 ,FDA ,CGMP,CE MARK .

Distribution:

Manzim Surgico's Instruments are distributed in South Korea,Spain, France, Germany, U.K, Rwanda, Australia,USA.

Customer Services:

Manzim Surgico is whole-heartedly committed to total customer satisfaction as our policy is Maximum Customer Satisfaction through: Best Quality Instruments, Competitive prices and on time Deliveries.

Contact No: 0092-52-3253436

Fax No: 0092-52-3253436

E-mail: support@manzimsurgico.com

info@manzimsurgico.com

Order Procedure:

When place an order by phone, fax or email please quote the following details.

- Order Number.
- Catalogue Number and description.
- Quantity
- Required Delivery Time.
- Special Marking (If any have)

Urgent Deliveries:

In case of urgency, we can dispatch orders within 1 to 2 weeks time.

Terms And Conditions:

The goods remain the property of Manzim Surgico until paid for in full. We only deal in terms of advance payment by T/T Telegraphic transfer or by irrevocable letter of credit L/C.

Guarantee:

MANZIM SURGICO Guaranteed unconditionally for three years, they clear boil and autoclave testing and are also passivated .The stainless steel to use manufacture instruments is the most suitable for the intended use of them. The fact that it will resist corrosion as it is further tested by different kind of chemical and physical testing. We use 410ss series of steel for non-cutting products and 420ss and french ss for cutting and scaling products.

Facility Address:

M/S: MANZIM SURGICO.

KHATANA STREET NEAR ISLAM MASJID,
P/O BOX 51310 S-I-E, SHATAB GARH, SIALKOT,
PAKISTAN.

TEL:0092-52-3253436

FAX:0092-52-3253436

EMAIL:info@manzimsurgico.com

sales@manzimsurgi.com

Web:www.manzimsurgico.com

Contacting Person: M.MUHAMMAD IMRAN

(Chief Executive)

Mobile # 0092-300-5159397

0092-307-5311117



G-001 Straight
G-002 Curved to side
5" (13cm)

BUSCH
Umbilical Cord
Scissors



G-003
4.25" (10.5cm)

AMERICAN
Umbilical Cord
Scissors

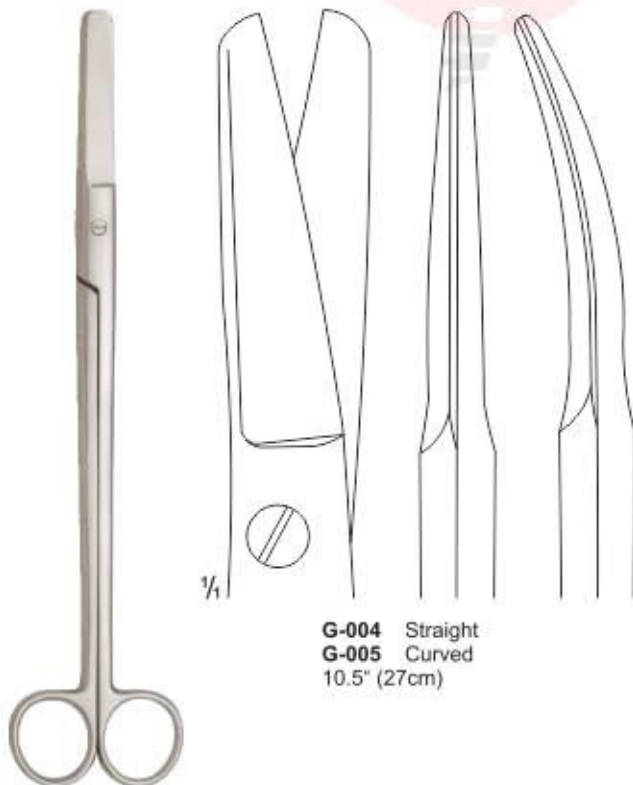

G-004 Straight
G-005 Curved
10.5" (27cm)

DUBOIS
Scissors

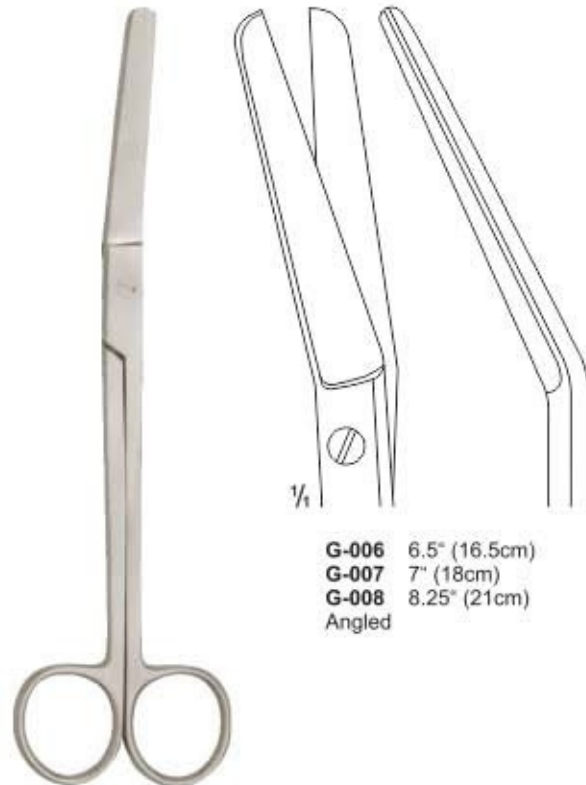

G-006 6.5" (16.5cm)
G-007 7" (18cm)
G-008 8.25" (21cm)
Angled

FERGUSSON
Uterine Scissors





SIMS
Uterine Scissors

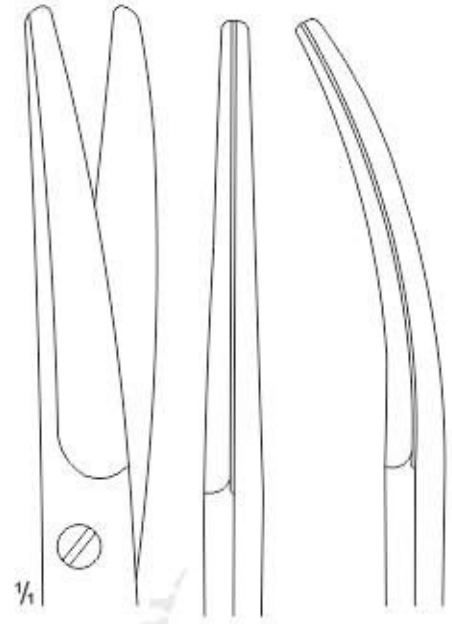

G-009 Straight
G-010 Curved
9" (23cm) Blunt/Blunt



UTERINE
Scissors

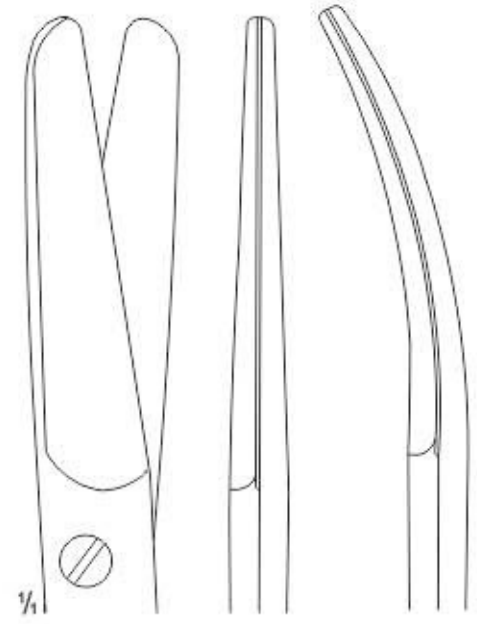

G-011 Straight
G-012 Curved
9" (23cm) Blunt/Blunt



LAWSON TAIT
Episiotomy scissors

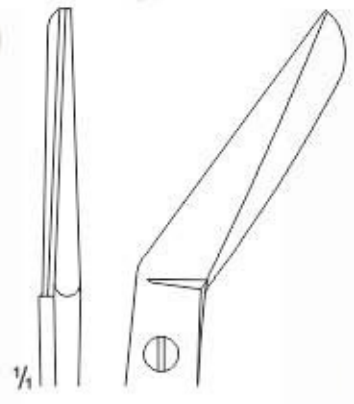

G-013
5.5" (14cm)



BRAUN STADLER
Episiotomy scissors



G-014
5.5" (14cm)

G-015
8.75" (22cm)

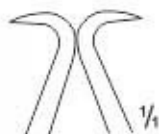

G-016
6" (15.5cm)

COMYN BERKELEY
Vulva Self Retaining



DOYEN

Supra Hollow Handle

- G-017** 3" x 11" (7.5cm x 28cm)
- G-018** 3.5" x 11" (9cm x 28cm)
- G-019** 4" x 11" (10cm x 28cm)
- G-020** 4.5" x 11" (11.5cm x 28cm)



DOYEN POZZI

Retractor

- G-021** 1 3/4" x 2" x 10"
(4.5cm x 5cm x 25.5cm)
- G-022** 1 3/4" x 3 1/2" x 10"
(4.5cm x 9cm x 25.5cm)
- G-023** 1 3/4" x 4 1/2" x 10"
(4.5cm x 11.5cm x 25.5cm)



G-024
8" (20cm)

GELPI
Vulva Self Retaining



DOYEN

Vaginal Flat Retractor

- G-025** 1 1/8" x 4" x 9"
(1.75cm x 10cm x 23cm)



JOLL Thyroid Self Retaining
G-026 6" (15.5cm)



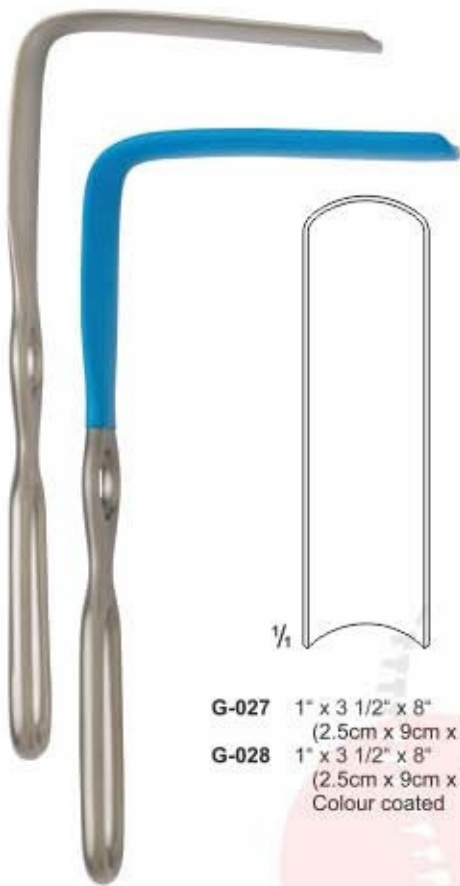

G-027 1" x 3 1/2" x 8"
(2.5cm x 9cm x 20cm)
G-028 1" x 3 1/2" x 8"
(2.5cm x 9cm x 20cm)
Colour coated

LANDON
Vaginal Retractor



G-029
1 1/2" x 3 3/4" x 10 3/4"
(3cm x 9.5cm x 27.5cm)

WERTHEIM
Retractor



G-030
7" (18cm)
Fine
Colour Coated

IRIS
Skin Hooks



G-031
10" (25.5cm)
Fine
Colour Coated

IRIS
Skin Hooks



G-032
9" (23cm)
bic

TENACULUM EMETT



G-033
10.25" (26cm)
bic

TENACULUM 3 PRONG



G-034
7.25" (18.5cm)
bic

WHITTAKER

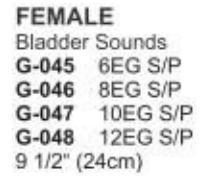
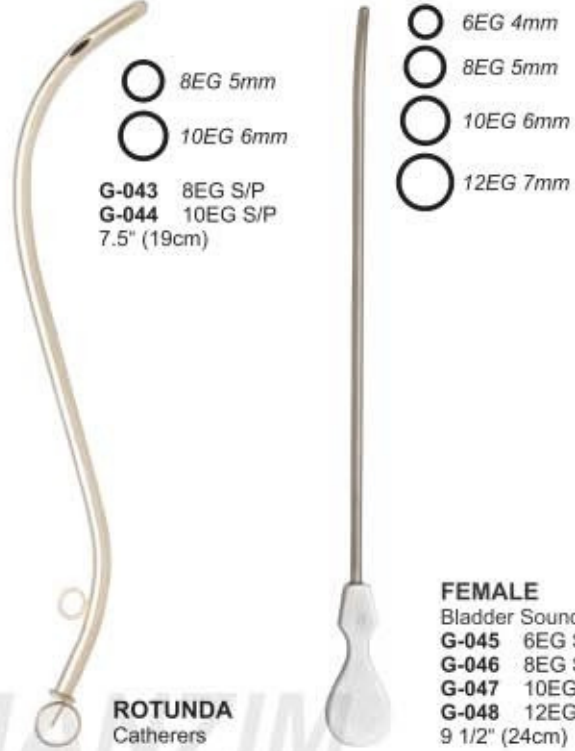

NEEDLE EXTENSIONS

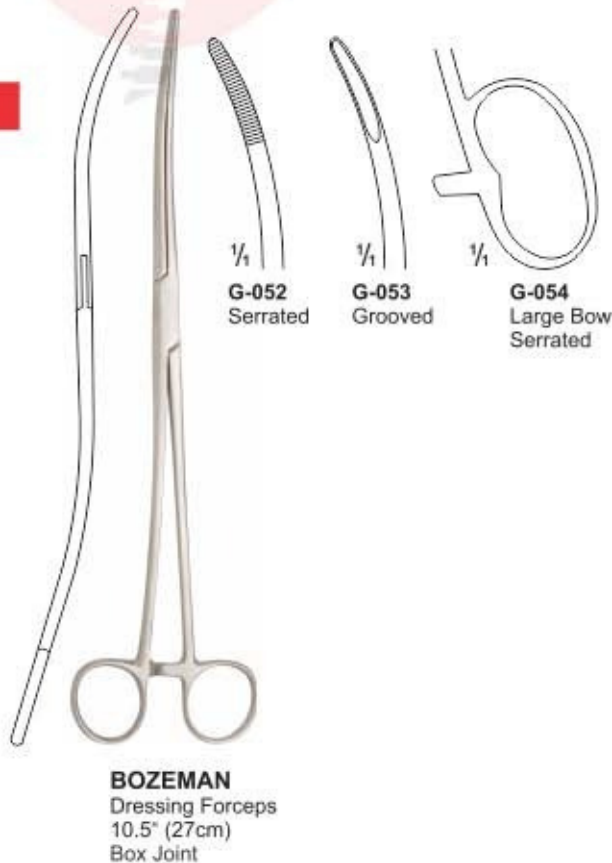



AUVARD
Speculum



G-057
38mm x 105 mm
Large Fixed weight



G-058
38mm x 105 mm
Large Fixed weight
Colour Coated



G-059
38mm x 105 mm
Small Loose weight

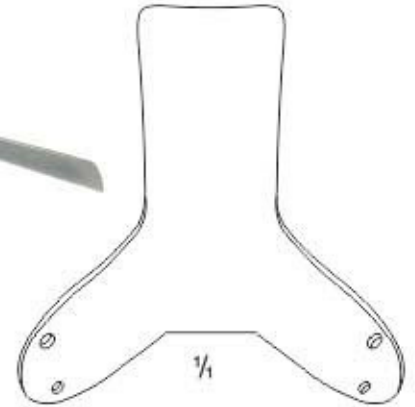

- G-060** 38mm x 75 mm
Small Fixed weight
- G-061** 38mm x 105 mm
Large Fixed weight
- G-062** 38mm x 105 mm
Large Fixed weight
Colour Coated
- G-063** 38mm x 75 mm
Small Loose weight
- G-064** 38mm x 105 mm
Small Loose weight



- COLLIN**
Speculum
- G-065** 30mm x 85mm
Small
 - G-066** 35mm x 100mm
Medium
 - G-067** 40mm x 110mm
Large



- CUSCO**
Virgin Speculum
- G-068** 15mm x 65mm
 - G-069** 15mm x 85mm
 - G-070** 25mm x 80mm, Small
 - G-071** 30mm x 90mm, Medium
 - G-072** 30mm x 115mm, Medium
 - G-073** 35mm x 95mm, Large



- CUSCO**
Virgin Speculum
- G-074** 17mm x 75mm Side Screw
 - G-075** 22mm x 80mm Small Side Screw
 - G-076** 25mm x 100mm Medium Side Screw
 - G-077** 27mm x 105mm Large Side Screw



CUSCO

Virgin Speculum
Laser black

- G-078** 15mm x 65mm
- G-079** 25mm x 80mm, Small
- G-080** 30mm x 90mm, Medium
- G-081** 35mm x 95mm, Large



GRAVES (Brewer)

Virgin Speculum

- G-082** 20mm x 75mm, Small
- G-083** 35mm x 95mm, Medium
- G-084** 35mm x 115mm, Large



GRAVES

Virgin Speculum
Color Coated, Straight

- G-085** 20mm x 75mm, Small
- G-086** 35mm x 95mm, Medium
- G-087** 35mm x 115mm, Large



GRAVES WIDE

Virgin Speculum
Color Coated, Straight

- G-088** 33mm x 105mm, Medium
- G-089** 34mm x 115mm, Large





Graves Vaginal Speculum Leep / Lietz
G-090 Small
G-091 Medium
G-092 Large
G-093 X-large



Pederson Vaginal Speculum Leep / Lietz
G-094 Small
G-095 Medium
G-096 Large
G-097 X-Large



WEISMAN
 Virgin Speculum
 Color Coated
G-098 35mm x 100mm, Left Open
G-099 35mm x 115mm, Right Open



PEDERSON
 Virgin Speculum
 Color Coated
G-100 17mm x 100mm, Narrow
G-101 13mm x 75mm, Small
G-102 22mm x 100mm, Medium
G-103 25mm x 120mm, Large



GRAVES WIDE

Virgin Speculum
Wide Pattern
G-104 33mm x 105mm, Medium
G-105 34mm x 115mm, Large

MANZIM
SURGICO

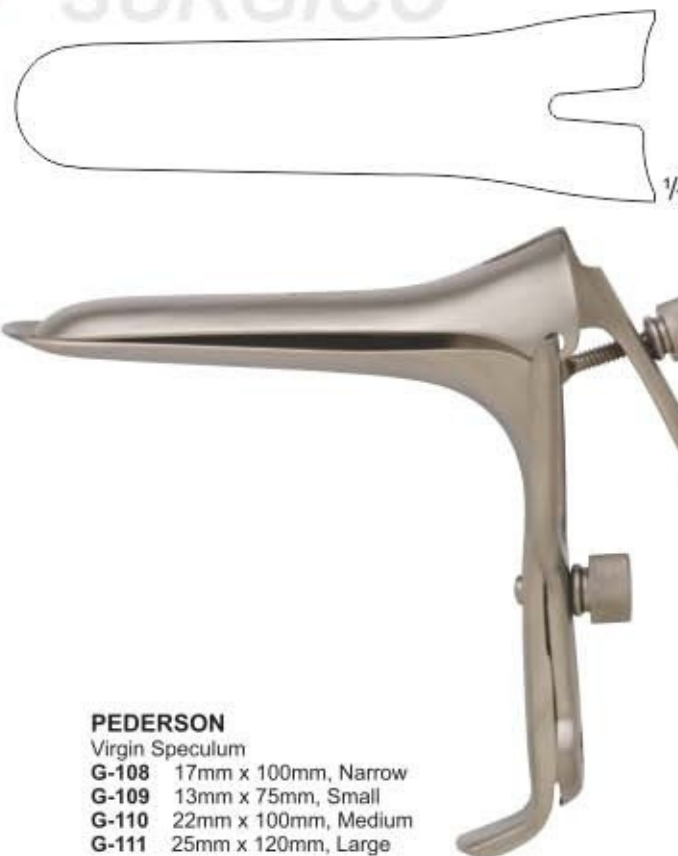

PEDERSON

Virgin Speculum
G-108 17mm x 100mm, Narrow
G-109 13mm x 75mm, Small
G-110 22mm x 100mm, Medium
G-111 25mm x 120mm, Large

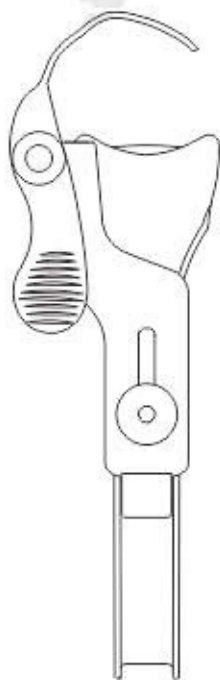
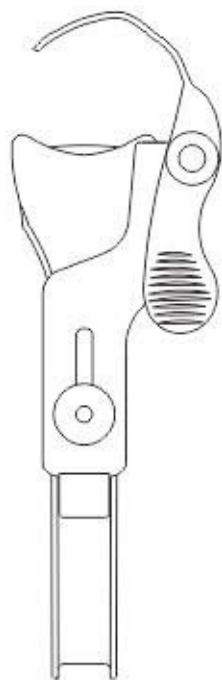

WEISMAN GRAVES

Virgin Speculum
G-106 35mm x 115mm
Left Open

WEISMAN GRAVES

Virgin Speculum
G-107 35mm x 115mm
Right Open



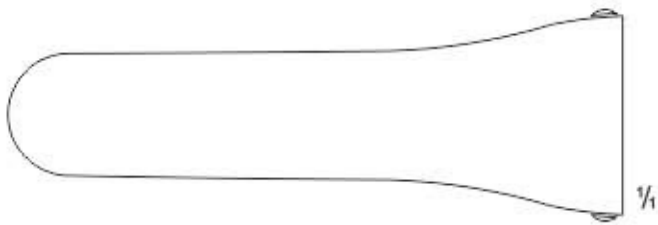

WINTERTON
Vaginal Speculum
G-112
23mm x 115mm

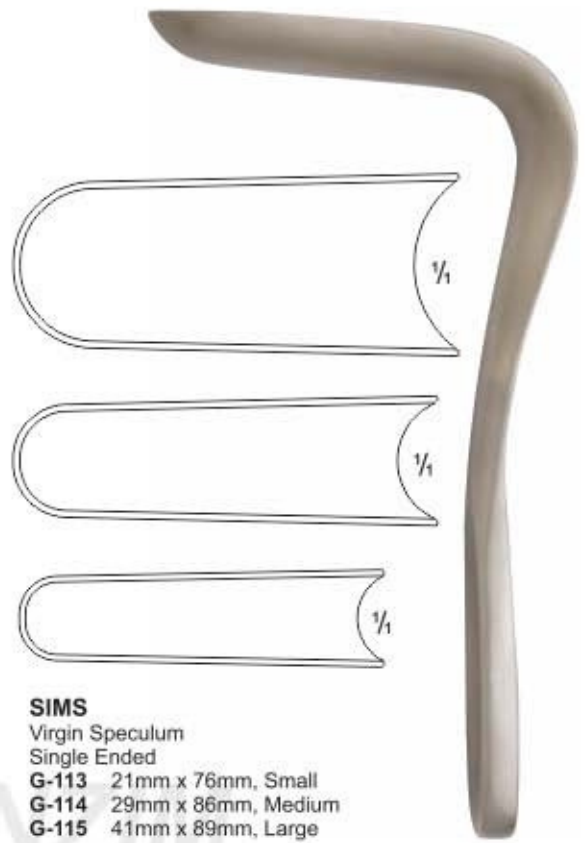

SIMS
Virgin Speculum
Single Ended
G-113 21mm x 76mm, Small
G-114 29mm x 86mm, Medium
G-115 41mm x 89mm, Large



SIMS
Virgin Speculum
Single Ended, Colour Coated
G-116 21mm x 76mm, Small
G-117 29mm x 86mm, Medium
G-118 41mm x 89mm, Large

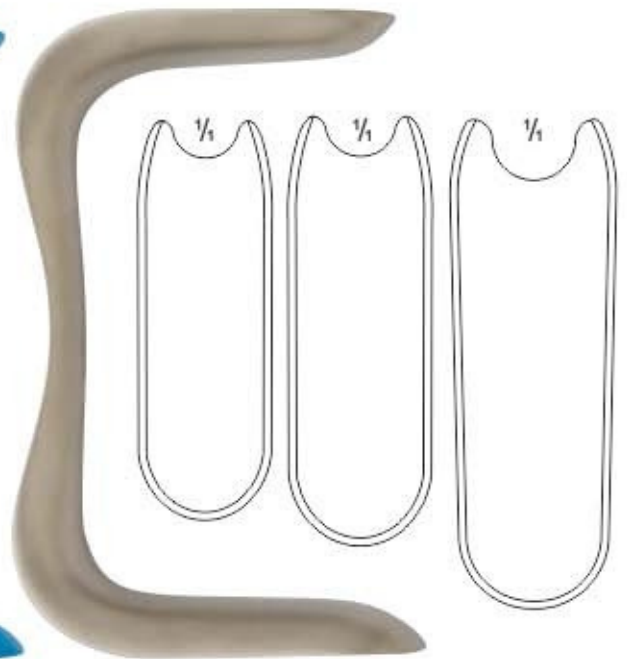

SIMS
Virgin Speculum
Double Ended, Colour Coated
G-119 26mm x 70mm, Small
30mm x 75mm
G-120 30mm x 75mm, Medium
35mm x 80mm
G-121 36mm x 80mm, Large
40mm x 90mm

SIMS
Virgin Speculum
Double Ended, Colour Coated
G-122 26mm x 70mm, Small
30mm x 75mm
G-123 30mm x 75mm, Medium
35mm x 80mm
G-124 36mm x 80mm, Large
40mm x 90mm



VAGINAL
Lateral Wall
Retractor
G-125
9.75" (25cm)
Wall retraction
Max. 2



VAGINAL
Lateral Wall
Retractor
G-126
9.75" (25cm)
Wall retraction
Max. 2

MANZIM
SURGICO



VAGINAL
Lateral Wall
Retractor
G-127
9.75" (25cm)
Wall retraction
Max. 3



VAGINAL
Lateral Wall
Retractor
G-128
9.75" (25cm)
Wall retraction
Max. 3





BURKE BIOPSY FORCEPS
G-129
8.5" (21.5cm) Shaft

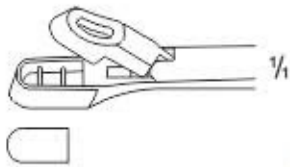

EPPENDORF BIOPSY FORCEPS
G-130
8" (20cm) Shaft

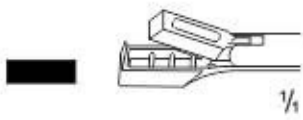

**KEVORKIAN YOUNG BIOPSY
FORCEPS**
G-131
10" (25.5cm) Shaft



**LEECHWILKINSON BIOPSY
FORCEPS**
G-132
8" (20cm) Shaft Round



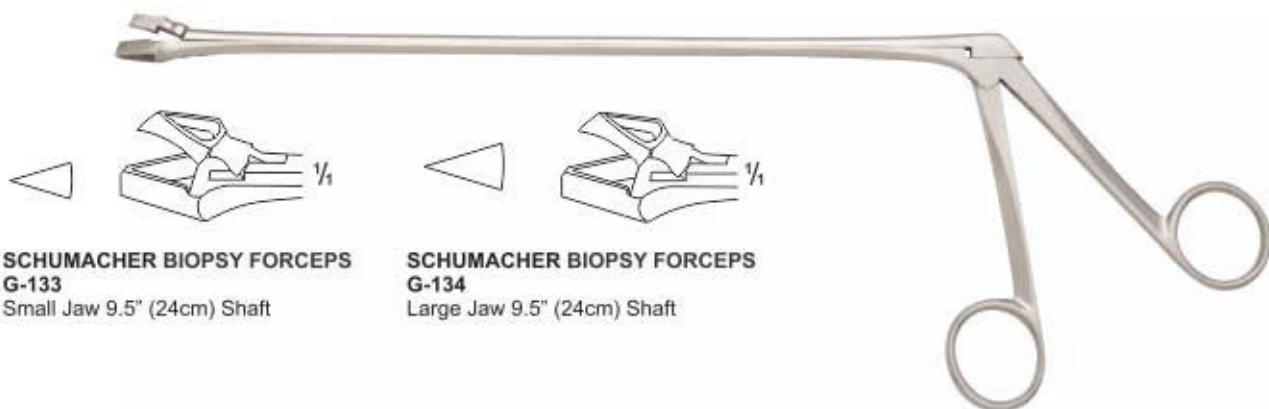

**SCHUMACHER BIOPSY FORCEPS
G-133**
Small Jaw 9.5" (24cm) Shaft

**SCHUMACHER BIOPSY FORCEPS
G-134**
Large Jaw 9.5" (24cm) Shaft

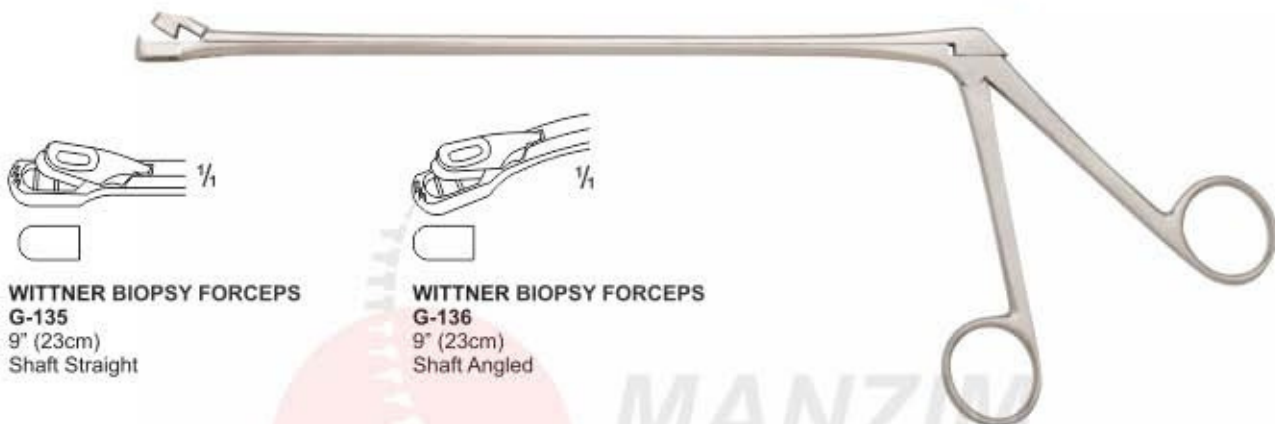

**WITNER BIOPSY FORCEPS
G-135**
9" (23cm)
Shaft Straight

**WITNER BIOPSY FORCEPS
G-136**
9" (23cm)
Shaft Angled

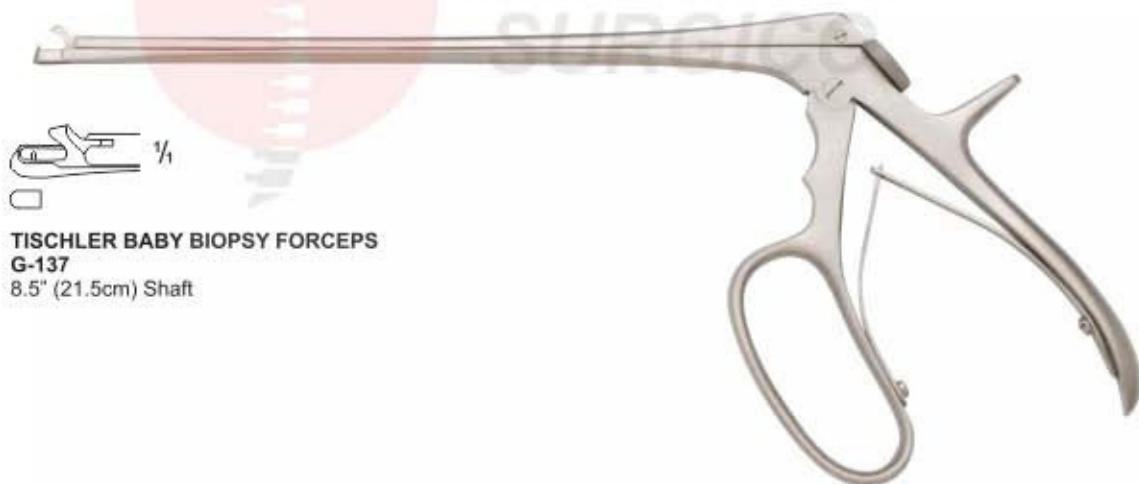

**TISCHLER BABY BIOPSY FORCEPS
G-137**
8.5" (21.5cm) Shaft



**TISCHLER BIOPSY FORCEPS
G-138**
8.5" (21.5cm) Shaft



**IUCD REMOVAL FORCEPS
G-139**
8" (20CM)
Shaft Serrated Jaw

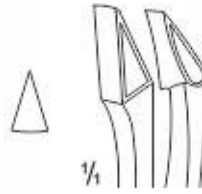
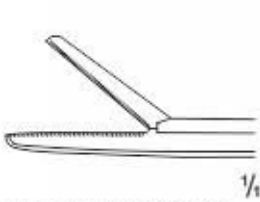

**SCHUMACHER
BIOPSY FORCEPS
G-140** 9.5" (24cm)
Small Jaw Box Joint

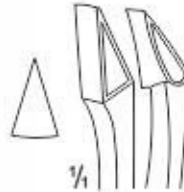

**SCHUMACHER
BIOPSY FORCEPS
G-141** 9.5"(2.4cm)
Large Jaw Box Joint



**THOMS-GAYLOR
BIOPSY FORCEPS
G-142** 8.75" (22cm)
Box Joint

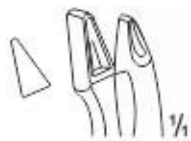

**VAN DORAN
BIOPSY FORCEPS
G-143** 10.5" (27cm)
Box Joint

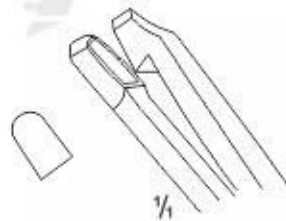

**SCHUBERT
BIOPSY FORCEPS
G-144** 10.25" (20cm)
Box Joint

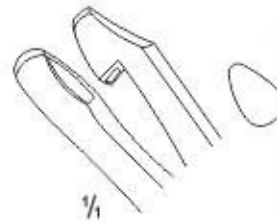

**FAURE BIOPSY
FORCEPS
G-145**
9.5" (21.5cm)

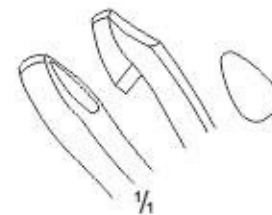

**FAURE BIOPSY
FORCEPS
G-146**
8.25" (21.5cm)

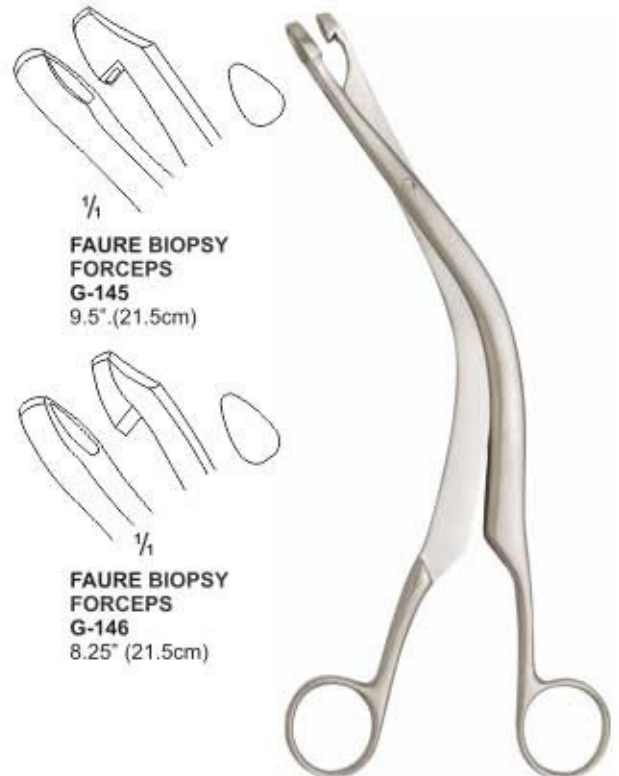

Many varieties of Dilators are available. Only showing in this catalogue the most popular European and North American designs.

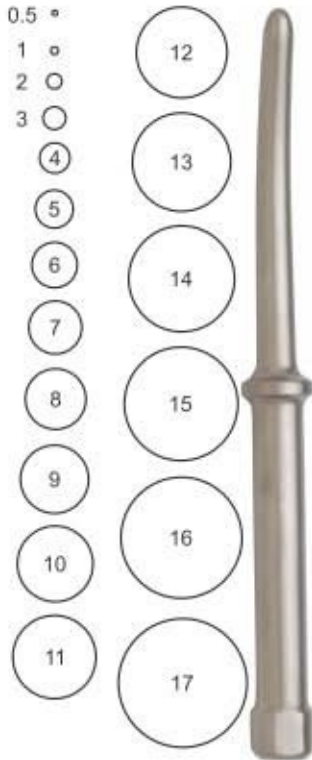

**BONNEY-BARKER
DILATORS**

- G-147 7.25" (18.5cm) 3-4-5mm
- G-148 7.25" (18.5cm) 4-5-6mm
- G-149 7.25" (18.5cm) 5-6-7mm
- G-150 7.25" (18.5cm) 6-7-8mm
- G-151 7.25" (18.5cm) 7-8-9mm
- G-152 7.25" (18.5cm) 8-9-10mm
- G-153 7.25" (18.5cm) 9-10-11mm
- G-154 7.25" (18.5cm) 10-11-12mm
- G-155 7.25" (18.5cm) 11-12-13mm
- G-156 7.25" (18.5cm) 12-13-14mm
- G-157 7.25" (18.5cm) 13-14-15mm
- G-158 7.25" (18.5cm) 14-15-16mm
- G-159 7.25" (18.5cm) 15-16-17mm
- G-160 7.25" (18.5cm) 16-17-18mm
- G-161 7.25" (18.5cm) 17-18-19mm
- G-162 7.25" (18.5cm) 18-19-20mm
- G-163 Set-16 7.5" (19mm)
- G-164 Canvas Roll



HANK DOUBLE ENDED

- G-165 10.5" (27cm) 9/10mm
- G-166 10.5" (27cm) 11/12mm
- G-167 10.5" (27cm) 13/14mm
- G-168 10.5" (27cm) 15/16mm
- G-169 10.5" (27cm) 17/18mm
- G-170 10.5" (27cm) 19/20mm
- G-171 Set 6 D/e 9/10-19/20mm



**HAWKIN AMBLER
DILATORS**

- G-172 6.75" (17cm) 3-6mm
- G-173 6.75" (17cm) 4-7mm
- G-174 6.75" (17cm) 5-8mm
- G-175 6.75" (17cm) 6-9mm
- G-176 6.75" (17cm) 7-10mm
- G-177 6.75" (17cm) 8-11mm
- G-178 6.75" (17cm) 9-12mm
- G-179 6.75" (17cm) 10-13mm
- G-180 6.75" (17cm) 11-14mm
- G-181 6.75" (17cm) 12-15mm
- G-182 6.75" (17cm) 13-16mm
- G-183 6.75" (17cm) 14-17mm
- G-184 6.75" (17cm) 15-18mm
- G-185 6.75" (17cm) 16-19mm
- G-186 6.75" (17cm) 17-20mm
- G-187 6.75" (17cm) 18-21mm
- G-188 Set of 16, 3/6-18/21mm
- G-189 Canvas Roll Only

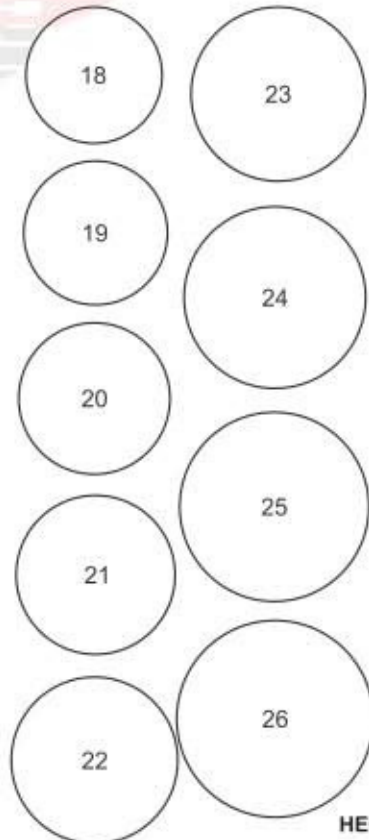

HEGAR SINGLE ENDED

- G-190 7.25" (18.5cm) 2mm
- G-191 7.25" (18.5cm) 3mm
- G-192 7.25" (18.5cm) 4mm
- G-193 7.25" (18.5cm) 5mm
- G-194 7.25" (18.5cm) 6mm
- G-195 7.25" (18.5cm) 7mm
- G-196 7.25" (18.5cm) 8mm
- G-197 7.25" (18.5cm) 9mm
- G-198 7.25" (18.5cm) 10mm
- G-199 7.25" (18.5cm) 11mm
- G-200 7.25" (18.5cm) 12mm
- G-201 7.25" (18.5cm) 13mm
- G-202 7.25" (18.5cm) 14mm
- G-203 7.25" (18.5cm) 15mm
- G-204 7.25" (18.5cm) 16mm
- G-205 7.25" (18.5cm) 17mm
- G-206 7.25" (18.5cm) 18mm
- G-207 7.25" (18.5cm) 19mm
- G-208 7.25" (18.5cm) 20mm
- G-209 7.25" (18.5cm) 21mm
- G-210 7.25" (18.5cm) 22mm
- G-211 7.25" (18.5cm) 23mm
- G-212 7.25" (18.5cm) 24mm
- G-213 7.25" (18.5cm) 25mm
- G-214 7.25" (18.5cm) 26mm
- G-215 Set of 12 S/E 3-14mm
- G-216 Set 12 S/E Canvas Only





- G-217 8" (20cm) 1/2mm
- G-218 8" (20cm) 3/4mm
- G-219 8" (20cm) 5/6mm
- G-220 8" (20cm) 7/8mm
- G-221 8" (20cm) 9/10mm
- G-222 8" (20cm) 11/12mm
- G-223 8" (20cm) 13/14mm
- G-224 8" (20cm) 15/16mm
- G-225 8" (20cm) 17/18mm
- G-226 8" (20cm) 19/20mm
- G-227 8" (20cm) 21/22mm
- G-228 8" (20cm) 23/24mm
- G-229 8" (20cm) 25/26mm
- G-230 Set 8 Double Ended 3/4mm-17/18mm
- G-231 Set 12 Double Ended 1/2mm-23/24mm
- G-232 Set 8 Double Ended Canvas Only
- G-233 Set 12 Double Ended Canvas Only

HEGAR DOUBLE ENDED DILATORS



- G-234 11.5" (29cm) 13/15 FG
- G-235 11.5" (29cm) 17/19 FG
- G-236 11.5" (29cm) 21/23 FG
- G-237 11.5" (29cm) 25/27 FG
- G-238 11.5" (29cm) 29/31 FG
- G-239 11.5" (29cm) 33/35 FG
- G-240 11.5" (29cm) 37/39 FG
- G-241 11.5" (29cm) 41/43 FG
- G-242 Set 8 Double Ended 13/15-41/43 FG

As an ongoing process, all dilators are being made from stainless steel, some like the Hawkin Amblers are still supplied in electroplated versions. All dilators are available in set configurations. We have listed the most popular set combinations.

PRATT DOUBLE ENDED DILATORS



- | | |
|----------------|----------------|
| G-243 1.0mm Ø | G-267 13.5mm Ø |
| G-244 1.5mm Ø | G-268 14.0mm Ø |
| G-245 2.0mm Ø | G-269 14.5mm Ø |
| G-246 2.5mm Ø | G-270 15.0mm Ø |
| G-247 3.0mm Ø | G-271 15.5mm Ø |
| G-248 3.5mm Ø | G-272 16.0mm Ø |
| G-249 4.0mm Ø | G-273 16.5mm Ø |
| G-250 4.5mm Ø | G-274 17.0mm Ø |
| G-251 5.0mm Ø | G-275 17.5mm Ø |
| G-252 6.0mm Ø | G-276 18.0mm Ø |
| G-253 6.5mm Ø | G-277 18.5mm Ø |
| G-254 7.0mm Ø | G-278 19.0mm Ø |
| G-255 7.5mm Ø | G-279 19.5mm Ø |
| G-256 8.0mm Ø | G-280 20.0mm Ø |
| G-257 8.5mm Ø | G-281 21.0mm Ø |
| G-258 9.0mm Ø | G-282 22.0mm Ø |
| G-259 9.5mm Ø | G-283 23.0mm Ø |
| G-260 10.0mm Ø | G-284 24.0mm Ø |
| G-261 10.5mm Ø | G-285 25.0mm Ø |
| G-262 11.0mm Ø | G-286 26.0mm Ø |
| G-263 11.5mm Ø | G-287 27.0mm Ø |
| G-264 12.0mm Ø | G-288 28.0mm Ø |
| G-265 12.5mm Ø | G-289 29.0mm Ø |
| G-266 13.0mm Ø | G-290 30.0mm Ø |

Hegar Uterine Dilator single ended

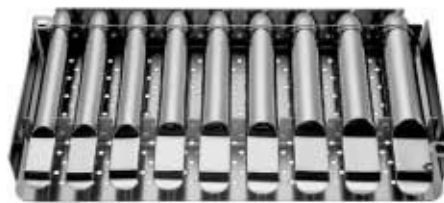

Hegar Uterine Dilator single ended
G-291 4 mm - 17 mm Ø
8 Pieces per set
G-292 1 mm - 26 mm Ø
24 Pieces per set



Hegar Uterine Dilator single ended
G-293 4 mm - 17 mm Ø
24 pieces per set

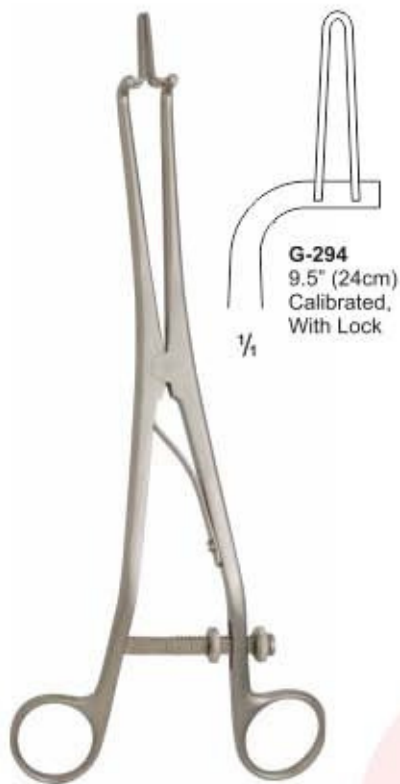

KOGAN VULSELLUM FORCEPS

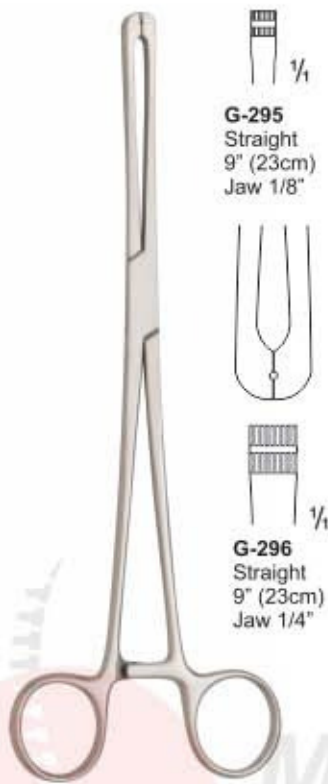

ATRAUMA VULSELLUM FORCEPS



ATRAUMA VULSELLUM FORCEPS
G-297 11.5" (29cm) 1/4" (0.5cm) Jaw + Sound

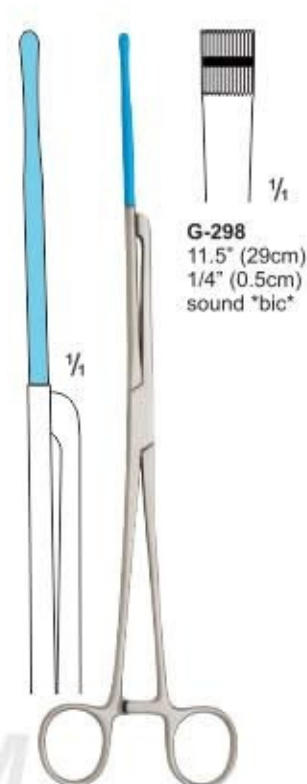

ATRAUMA VULSELLUM FORCEPS



CERVICAL DISSECTING FORCEP

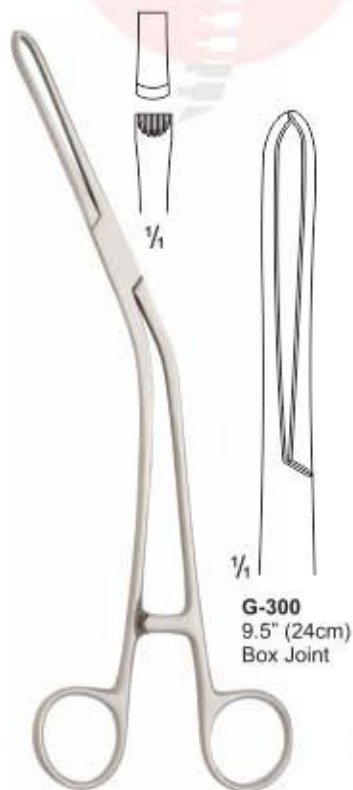

Bierer Vulsellum Tenaculum Forceps Angled

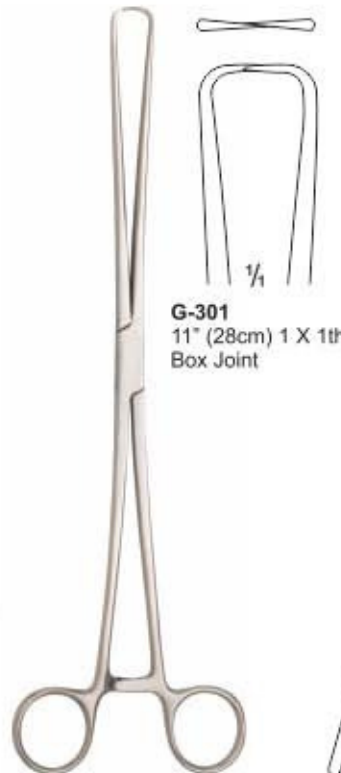

DUPLAY VULSELLUM FORCEPS

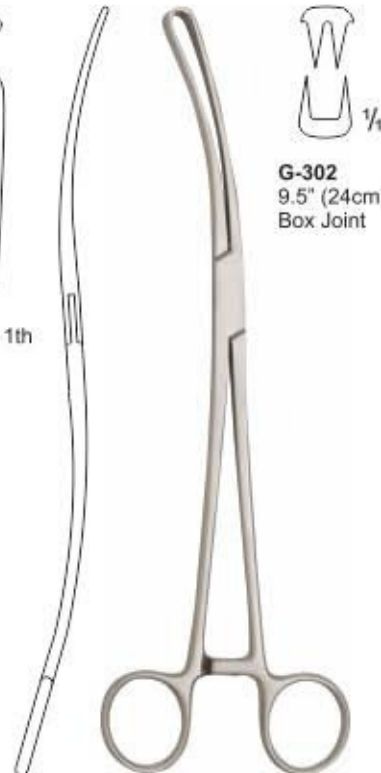

LEWER VULSELLUM FORCEPS
(Also known as 'Museum')





G-303
10" (25.5cm) 1 X
Box Joint

BRAUN VULSELLUM FORCEPS



G-304
9.5" (24cm) 1 X 1
Box Joint

LUER VULSELLUM FORCEP



G-305
9.5" (24cm) 1 X 1th Box
Joint "bic"

LUER VULSELLUM FORCEP



LUER VULSELLUM FORCEPS + SOUND
G-306 12" (30.5cm) Box Joint

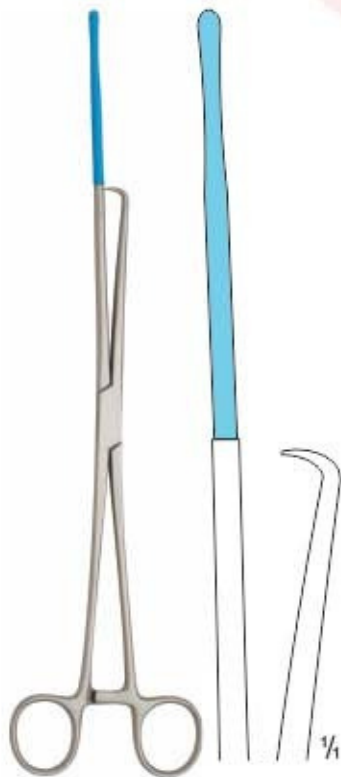

LUER VULSELLUM FORCEPS + SOUND
G-307 12" (30.5cm)



G-308
10.5" (27cm)
1 X 1th

ROTUNDA VULSELLUM FORCEPS

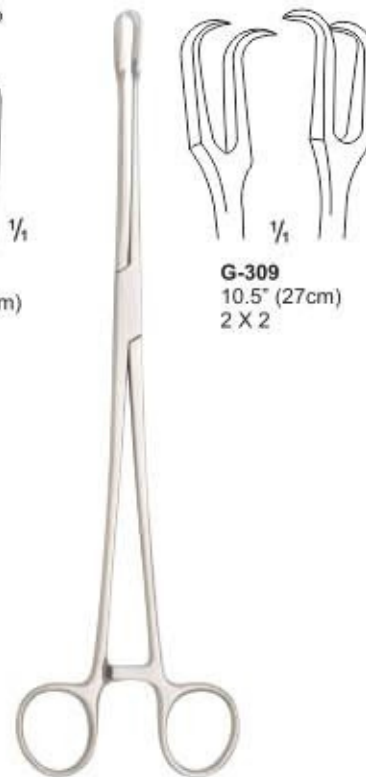

G-309
10.5" (27cm)
2 X 2

SCHROEDER VULSELLUM FORCEP



G-310 Straight
10.5" (27cm)
G-311 Curved
7" (18cm)
G-312 Curved
9.5" (24cm)

TEAL VULSELLUM FORCEPS



RECAMIER



G-313
No. 00, 5mm



G-314
No. 0, 6mm



G-315
No. 1, 7mm



G-316
No. 2, 8mm



G-317
No. 3, 9mm



G-318
No. 4, 11mm



G-319
No. 5, 12mm



G-320
No. 6, 14mm



G-321
No. 8, 16mm



G-322
No. 13, 25mm



G-323
No. 14, 30mm



G-324
No. 15, 35mm



G-325
No. 16, 40mm



G-326
No. 9, 19mm



G-327
No. 10, 20mm

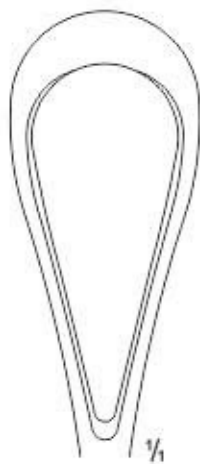

G-328
No. 11, 21mm

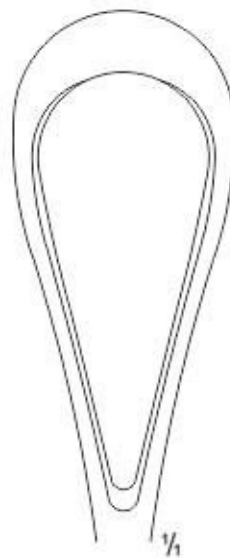

G-329
No. 7, 15mm

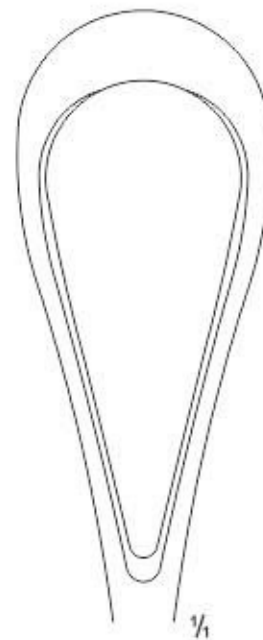

G-330
No. 12, 23mm





RECAMIER

RECAMIER RIGID

- G-331 00 5MM SHARP 12.5" (32CM)
- G-332 0 6MM SHARP 12.5" (32CM)
- G-333 1 7MM SHARP 12.5" (32CM)
- G-334 2 8MM SHARP 12.5" (32CM)
- G-335 3 9MM SHARP 12.5" (32CM)
- G-336 4 11MM SHARP 12.5" (32CM)
- G-337 5 12MM SHARP 12.5" (32CM)
- G-338 6 14MM SHARP 12.5" (32CM)
- G-339 7 15MM SHARP 12.5" (32CM)
- G-340 8 16MM SHARP 12.5" (32CM)
- G-341 9 19MM SHARP 12.5" (32CM)
- G-342 10 20MM SHARP 12.5" (32CM)
- G-343 11 21MM SHARP 12.5" (32CM)
- G-344 12 23MM SHARP 12.5" (32CM)
- G-345 13 25MM SHARP 12.5" (32CM)
- G-346 14 30MM SHARP 12.5" (32CM)
- G-347 15 35MM SHARP 12.5" (32CM)
- G-348 16 40MM SHARP 12.5" (32CM)

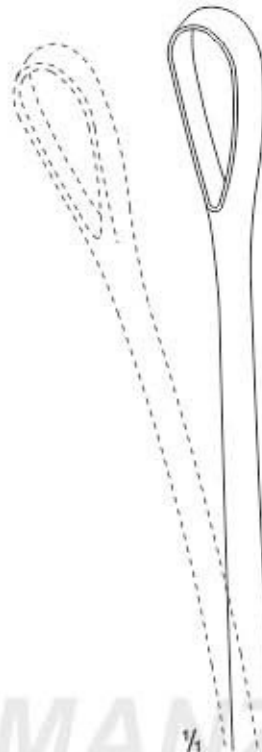

RECAMIER MALLEABLE

- G-349 00 5MM SHARP 12.5" (32CM)
- G-350 0 6MM SHARP 12.5" (32CM)
- G-351 1 7MM SHARP 12.5" (32CM)
- G-352 2 8MM SHARP 12.5" (32CM)
- G-353 3 9MM SHARP 12.5" (32CM)
- G-354 4 11MM SHARP 12.5" (32CM)
- G-355 5 12MM SHARP 12.5" (32CM)
- G-356 6 14MM SHARP 12.5" (32CM)
- G-357 7 15MM SHARP 12.5" (32CM)
- G-358 8 16MM SHARP 12.5" (32CM)
- G-359 9 19MM SHARP 12.5" (32CM)
- G-360 10 20MM SHARP 12.5" (32CM)
- G-361 11 21MM SHARP 12.5" (32CM)
- G-362 12 23MM SHARP 12.5" (32CM)
- G-363 13 25MM SHARP 12.5" (32CM)
- G-364 14 30MM SHARP 12.5" (32CM)
- G-365 15 35MM SHARP 12.5" (32CM)
- G-366 16 40MM SHARP 12.5" (32CM)



RECAMIER

RECAMIER RIGID

- G-367 00 5mm Blunt 12.5" (32cm)
- G-368 0 6mm Blunt 12.5" (32cm)
- G-369 1 7mm Blunt 12.5" (32cm)
- G-370 2 8mm Blunt 12.5" (32cm)
- G-371 3 9mm Blunt 12.5" (32cm)
- G-372 4 11mm Blunt 12.5" (32cm)
- G-373 5 12mm Blunt 12.5" (32cm)
- G-374 6 14mm Blunt 12.5" (32cm)
- G-375 7 15mm Blunt 12.5" (32cm)
- G-376 8 16mm Blunt 12.5" (32cm)
- G-377 9 19mm Blunt 12.5" (32cm)
- G-378 10 20mm Blunt 12.5" (32cm)
- G-379 11 21mm Blunt 12.5" (32cm)
- G-380 12 23mm Blunt 12.5" (32cm)
- G-381 13 25mm Blunt 12.5" (32cm)
- G-382 14 30mm Blunt 12.5" (32cm)
- G-383 15 35mm Blunt 12.5" (32cm)
- G-384 16 40mm Blunt 12.5" (32cm)

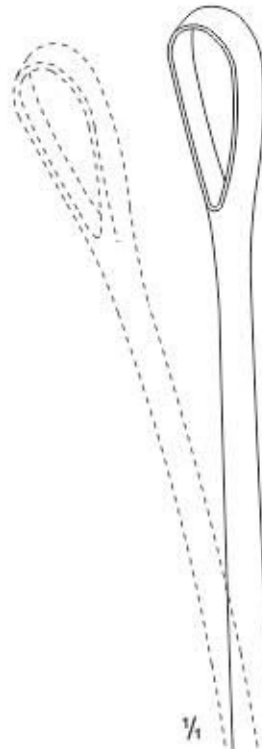

RECAMIER MALLEABLE

- G-385 00 5mm Blunt 12.5" (32cm)
- G-386 0 6mm Blunt 12.5" (32cm)
- G-387 1 7mm Blunt 12.5" (32cm)
- G-388 2 8mm Blunt 12.5" (32cm)
- G-389 3 9mm Blunt 12.5" (32cm)
- G-390 4 11mm Blunt 12.5" (32cm)
- G-391 5 12mm Blunt 12.5" (32cm)
- G-392 6 14mm Blunt 12.5" (32cm)
- G-393 7 15mm Blunt 12.5" (32cm)
- G-394 8 16mm Blunt 12.5" (32cm)
- G-395 9 19mm Blunt 12.5" (32cm)
- G-396 10 20mm Blunt 12.5" (32cm)
- G-397 11 21mm Blunt 12.5" (32cm)
- G-398 12 23mm Blunt 12.5" (32cm)
- G-399 13 25mm Blunt 12.5" (32cm)
- G-400 14 30mm Blunt 12.5" (32cm)
- G-401 15 35mm Blunt 12.5" (32cm)
- G-402 16 40mm Blunt 12.5" (32cm)



RECAMIER

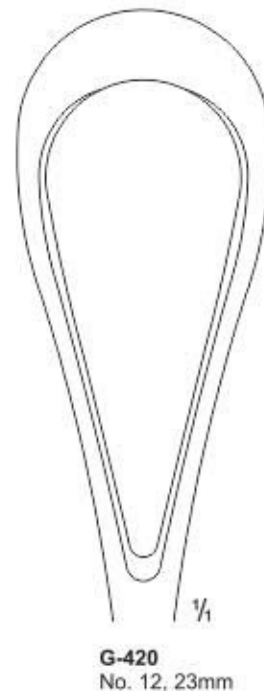
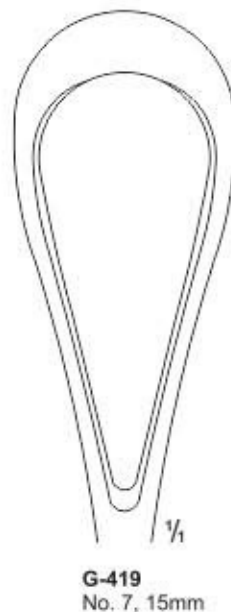
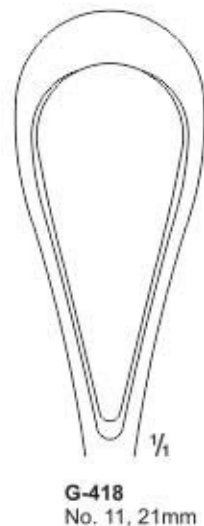
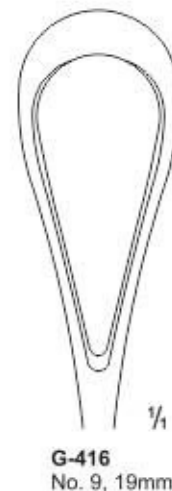
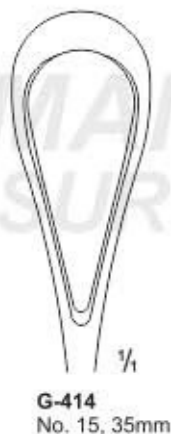
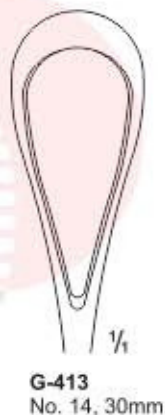
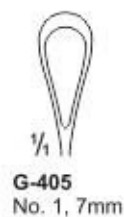
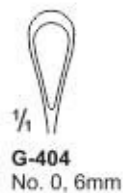



**SIMS
SINGLE ENDED
SHARP**

G-421
Small 1/4" (6mm)
Sharp 10" (25.5cm)



G-424
Small 1/4" (6mm)
Blunt 10" (25.5cm)



G-422
3Medium 3/8" (9mm)
Sharp 10" (25.5cm)



G-425
Medium 3/8" (9mm)
Blunt 10" (25.5cm)



G-423
Large 1/2" (12mm)
Sharp 10" (25.5cm)



G-426
Large 1/2" (12mm)
Blunt 10" (25.5cm)



**SIMS
SINGLE ENDED
BLUNT**

G-427
Small (1/4" X 3/16")
(6mm X 5mm) Sharp
Sharp 10" (25.5cm)

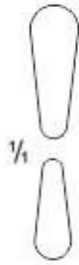

G-428
Medium (3/8" X 1/4")
(9mm X 6mm) Sharp
Sharp 10" (25.5cm)



G-429
Large (1/2" X 3/8")
(12mm X 9mm) Sharp
Sharp 10" (25.5cm)

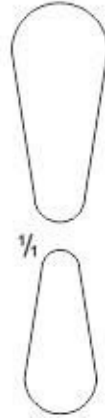

G-430
12" (30.5cm)

**KEVORKIAN
ENDOCERVICAL
CURETTES
With Basket Square**



**KEVORKIAN
ENDOCERVICAL
CURETTES
With Basket Round**

G-431
12" (30.5cm)

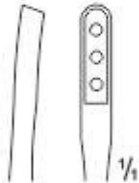

**KEVORKIAN
ENDOCERVICAL
CURETTES
Without Basket Square**

G-432
12" (30.5cm)



**SIMS
DOUBLE ENDED
S/S**

G-433
Small (1/4" X 3/16")
(6mm X 5mm) Sharp
Blunt 10" (25.5mm)



G-434
Medium (3/8" X 1/4")
(9mm X 6mm) Sharp
Blunt 10" (25.5mm)



G-435
Large (1/2" X 3/8")
(12mm X 9mm) Sharp
Blunt 10" (25.5mm)

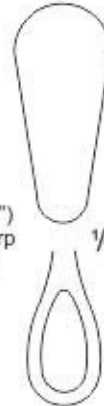

**SIMS
DOUBLE ENDED
SHARP BLUNT**

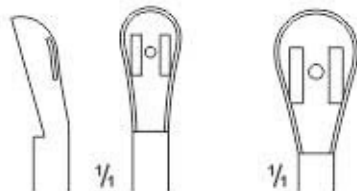

G-436
Small 11.5" (29cm)
5/16" (8mm) Sharp

G-437
Medium 11.5" (29cm)
7/16" (11mm) Sharp

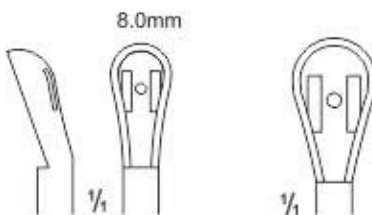

G-439
Small 11.5" (29cm)
5/16" (8mm) Blunt

G-440
Medium 11.5" (29cm)
7/16" (11mm) Blunt

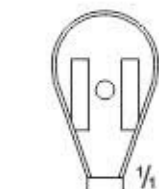

G-438
Large 11.5" (29cm)
9/16" (14mm) Sharp



G-441
Large 11.5" (29cm)
9/16" (14mm) Blunt



G-442
12 FG 4mm
10" (25.5cm)

RHEINSTADTER
FLUSHING CURETTES

RHEINSTADTER
FLUSHING CURETTES

LEECHWILKINSON
SUCTION BIOPSY CURETTES



1 ● G-443
2 ● G-444
3 ● G-445
4 ● G-446

1mm 10" (25.5cm)
2mm 10" (25.5cm)
3mm 10" (25.5cm)
4mm 10" (25.5cm)



2 ● G-447
3 ● G-448
4 ● G-449

2mm 10" (25.5cm)
3mm 10" (25.5cm)
4mm 10" (25.5cm)



10FG 3.3mm

G-450
10FG 9"
(23cm) C/P

NOVAK SUCTION
BIOPSY CURETTES

RANDALL SUCTION
BIOPSY CURETTES

SHARMAN ENDOMETRIAL
BIOPSY CURETTES

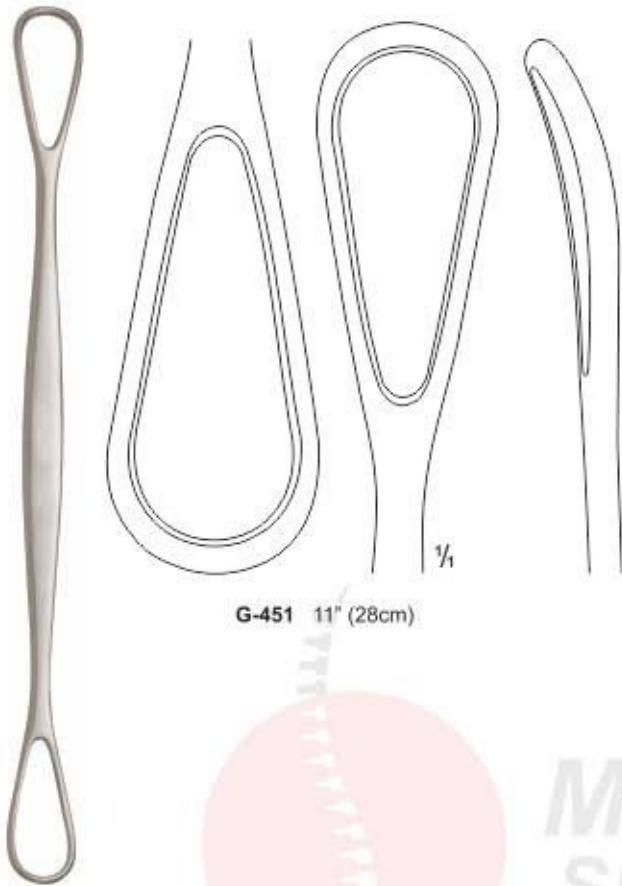

G-451 11" (28cm)

**BRAUN UTERINE
DOUBLE ENDED**

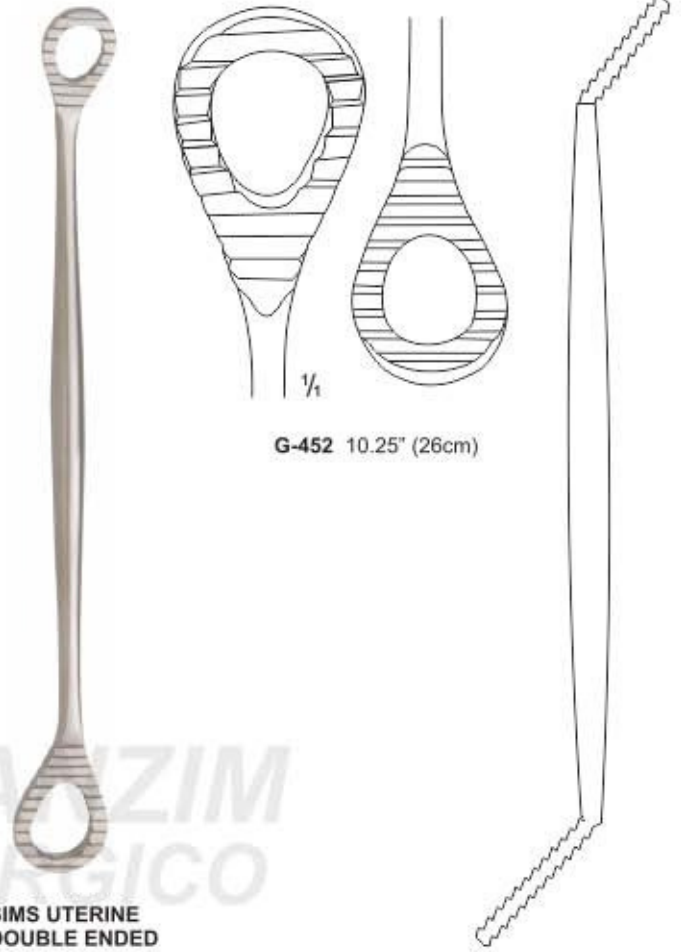

G-452 10.25" (26cm)

**SIMS UTERINE
DOUBLE ENDED**

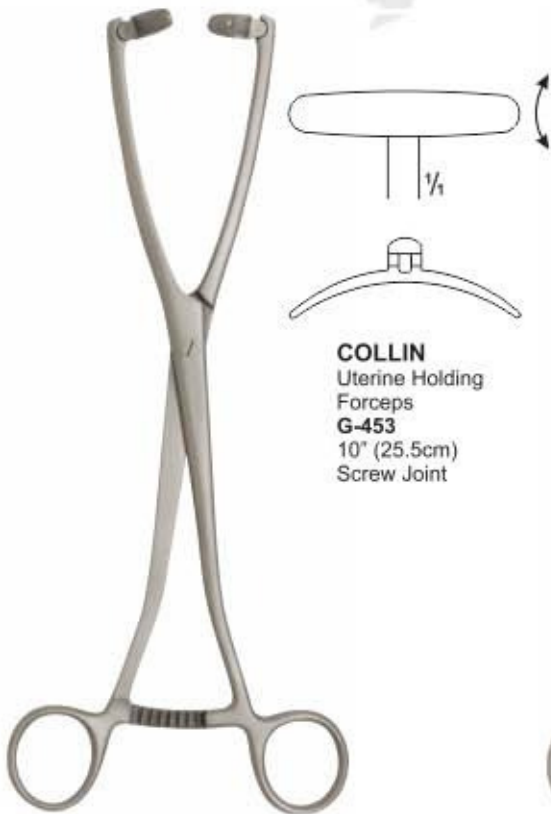

COLLIN
Uterine Holding
Forceps
G-453
10" (25.5cm)
Screw Joint



DARTIGUE
Uterine Holding
Forceps
G-454
10.5" (27cm)
Screw Joint

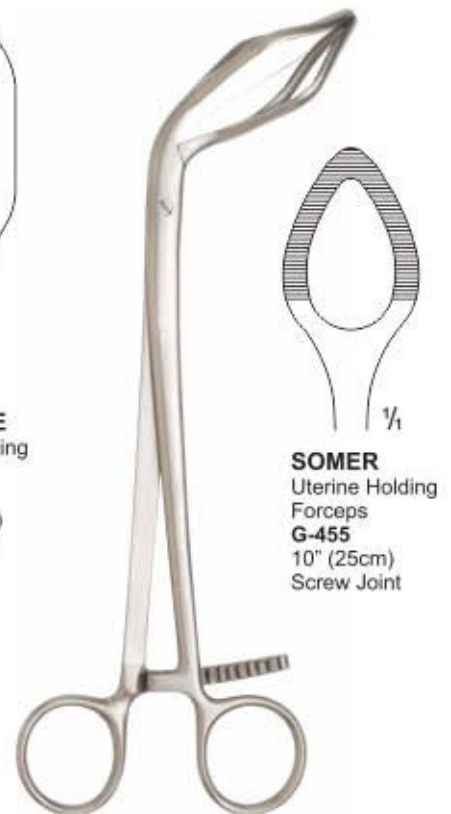

SOMER
Uterine Holding
Forceps
G-455
10" (25cm)
Screw Joint



G-456
8" (20cm)
1 x 2th, Angled
Screw Joint

BONNEY



G-457
8" (20cm)
1 x 2th, Curved
Screw Joint

BONNEY-BERKLEY

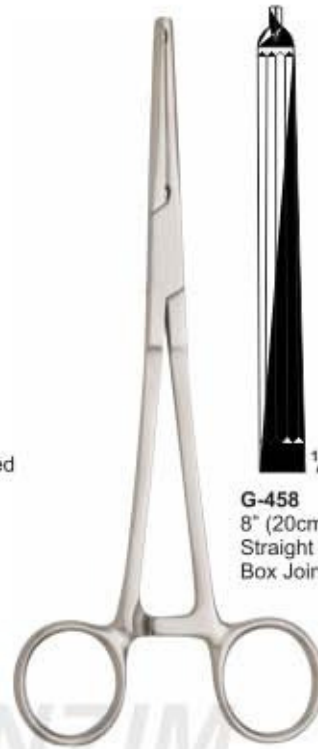

G-458
8" (20cm)
Straight
Box Joint

GWILLIAM



G-459
8" (20cm)
Curved
Box Joint



G-460
8" (20cm)
Curved
1 tooth
Box Joint

HEANEY



G-461
8" (20cm)
Curved
2 Teeth
Box Joint



G-462
9" (23cm)
Curved
Box Joint

HUNTER



G-463
8" (20cm)
Straight
Box Joint

MAINGOT



G-464
8" (20cm)
Curved
Box Joint





McCULLAGH

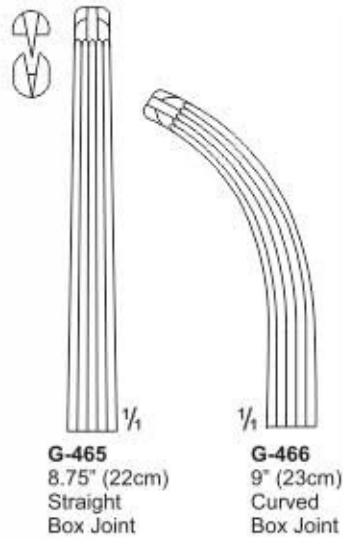

NAV RATILL

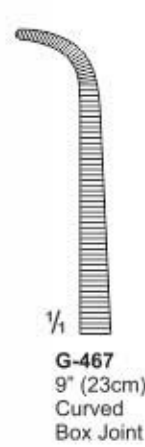

WERTHEIM

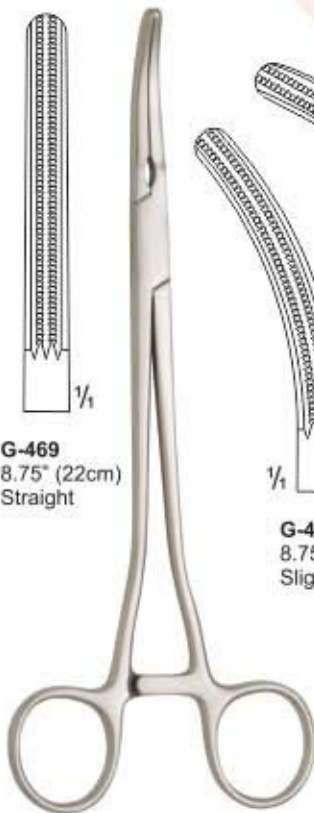
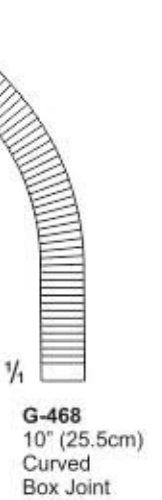

PARAMETRIUM

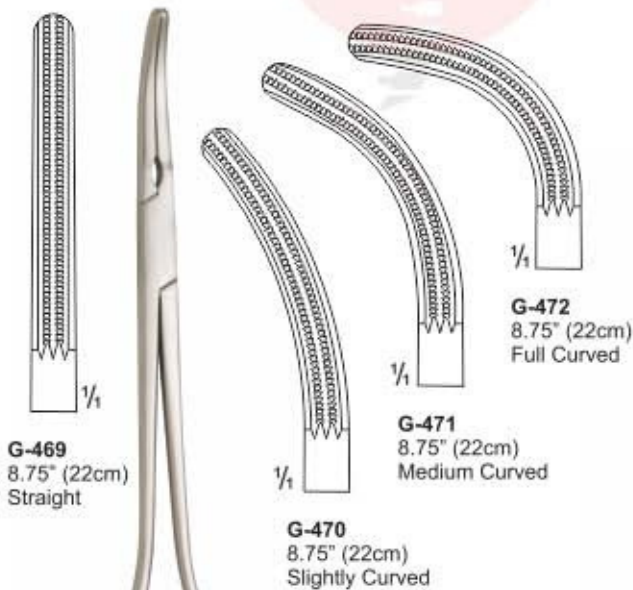

BONNEY POLYPUUS

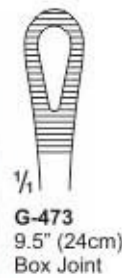

KELLY POLYPUUS

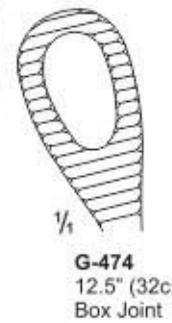

POLYPUUS

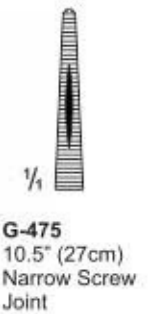

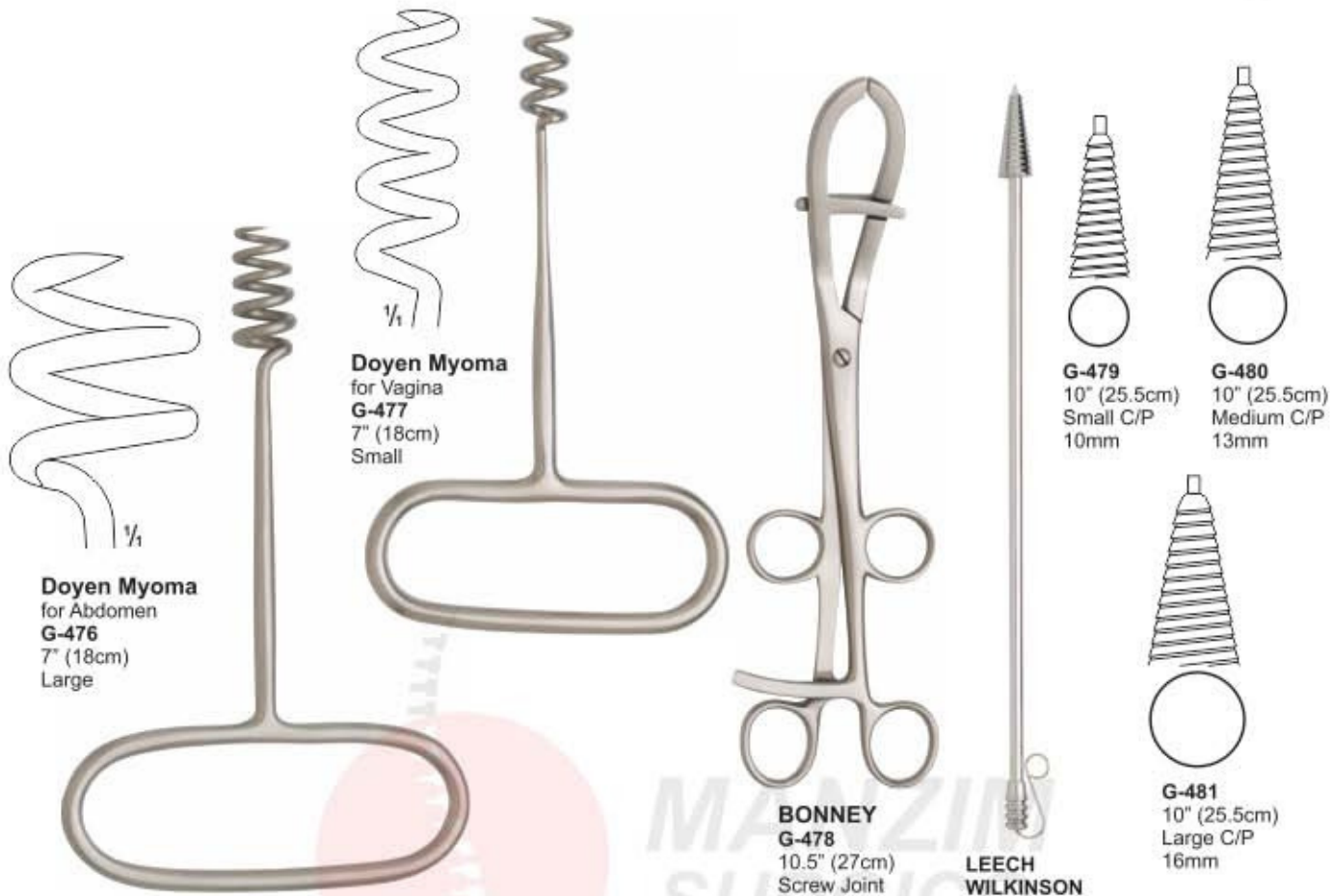

Doyen Myoma
for Vagina
G-477
7" (18cm)
Small

Doyen Myoma
for Abdomen
G-476
7" (18cm)
Large

BONNEY
G-478
10.5" (27cm)
Screw Joint

LEECH WILKINSON

G-479
10" (25.5cm)
Small C/P
10mm

G-480
10" (25.5cm)
Medium C/P
13mm

G-481
10" (25.5cm)
Large C/P
16mm

INSUFFLATION CANNULAS

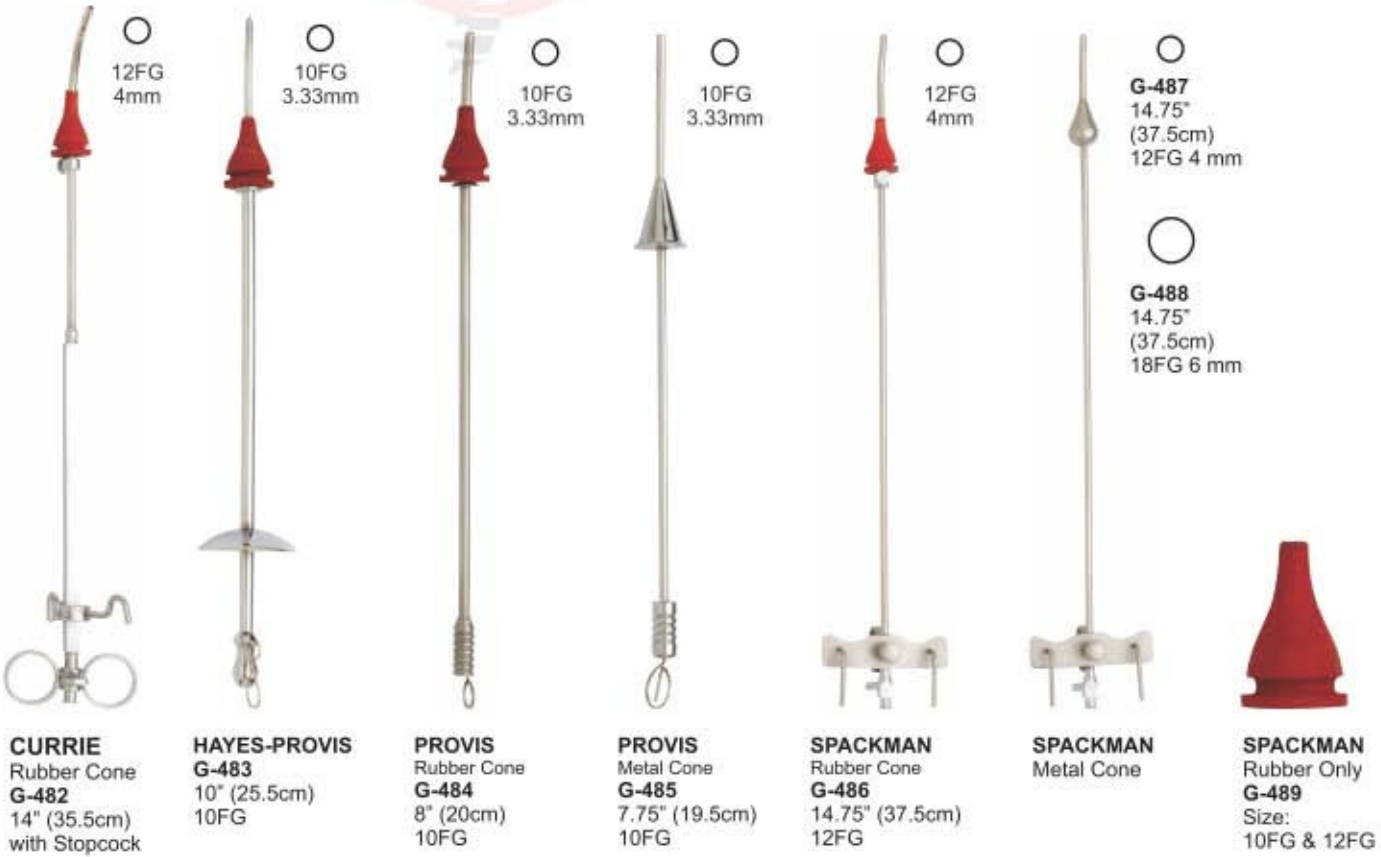

CURRIE
Rubber Cone
G-482
14" (35.5cm)
with Stopcock

HAYES-PROVIS
G-483
10" (25.5cm)
10FG

PROVIS
Rubber Cone
G-484
8" (20cm)
10FG

PROVIS
Metal Cone
G-485
7.75" (19.5cm)
10FG

SPACKMAN
Rubber Cone
G-486
14.75" (37.5cm)
12FG

SPACKMAN
Metal Cone

SPACKMAN
Rubber Only
G-489
Size:
10FG & 12FG



G-490
12" (30.5cm)
Tip 4mm S/p

GALABIN



G-491
11" (28cm)
Tip 3mm S/p

HORROCK



G-492
12" (30.5cm)
Tip 4mm S/p

SIMPSON



G-493
12.5" (32cm)
Tip 4mm S/p

SIMS



G-494
12.5" (32cm)
Tip 5mm

GRAFENBERG



G-495
8" (20cm)
Straight
Screw Joint

GREEN-ARMYTAGE

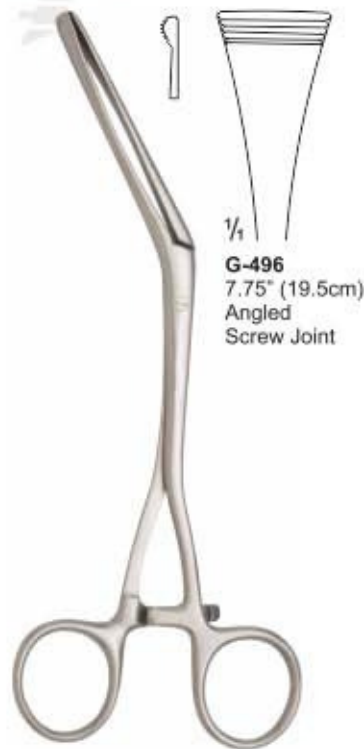

G-496
7.75" (19.5cm)
Angled
Screw Joint

GREEN-ARMYTAGE



G-497
13.75" (35cm)
8EG 5mm, S/l

DREWSMYTHE



G-498
10.25" (26cm)
Box Joint

GOODWIN



BRAUN
Cranioclast
G-499
16.5" (35cm)



WINTER
Cranioclast
G-500
16.5" (35cm)



G-501
11" (28cm)
8mm

G-502
11" (28cm)
10mm

G-503
11" (28cm)
12mm

G-504
11" (28cm)
14mm

G-505
11" (28cm)
16mm

BIERER
UTERUS EVACUATION /
ASPIRATION CURETTES

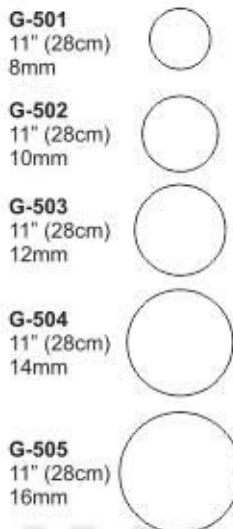
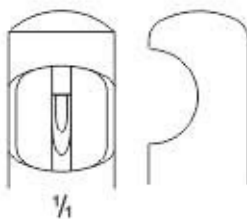

CARTON
Mucous Evacuator
G-506
9" (23cm)

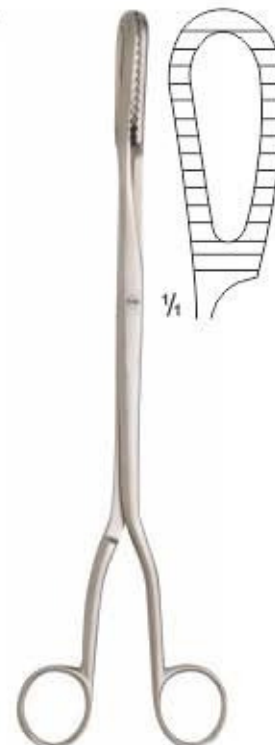

BIERER
Ovum Forceps
G-507
11" (28cm), Screw joint



GREENHALGH
Ovum Forceps
G-508
9.5" (24cm), Screw joint



HEYWOOD SMITH
Ovum Forceps
G-509
10.5" (27cm), Screw joint



MCLINTOCK
Ovum Forceps
G-510 Curved
9.5" (24cm), Screw joint



WILLETT
Placenta Forceps
G-511 Curved
7.5" (19cm), Screw joint

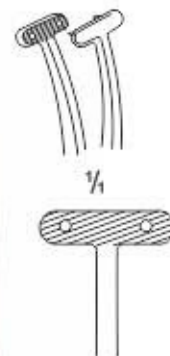



ANDERSON
Midwifery Forceps
G-512
15" (38cm)



BARNES
Neville Midwifery
Forceps
G-513
15" (38cm)



DE LEE
Midwifery Forceps
G-514
12" (30.5cm)



HAIG
Ferguson
Midwifery Forceps
G-515
14" (35.5cm)



KIELLAND
Midwifery Forceps
G-516
16" (40.5cm)



KIELLAND LUIKART
Midwifery Forceps
G-517
15.5" (39.5cm)



MILNE MURRAY
Midwifery Forceps
G-518
13" (33cm)



SIMPSON
Midwifery Forceps
G-519 11" (28cm)
G-520 15" (38cm)



TARNIER
Midwifery Forceps
G-521
15.75" (40cm)



WRIGLEY
Midwifery Forceps
G-522
11" (28cm)



BREISKY
G-523
13" (33cm)



MARTIN
G-524
13.5" (34.5cm)



DENMAN
G-525 Screw Joint
10.5" (25.5cm)



SIMPSON
G-526 Screw Joint
10.5" (25.5cm)



UMBILICAL
G-527
3.75" (9.5cm)



PINARD
Stethoscopes
G-528
5" (13cm) Plastic Black



PINARD
Stethoscopes
G-529
6" (15cm) Aluminium



DESCRIPTION	PAGE #
A	
American Umbilical Cord Scissors	01
Anderson Midwifery Forceps	30
Atrauma Vulsellum Forceps	17
Auvard Speculum	06
B	
Barnes Neville Midwifery Forceps	30
Bierer Ovum Forceps	29
Bierer Uterus Evacuation / Aspiration Curettes	29
Bierer Vulsellum Tenaculum Forceps	17
Bonney Hysterectomy Clamps	27
Bonney Polypus Forceps	26
Bonney Uterus Holding Forceps	25
Bonney Vaginal Clamps	05
Bonney-barker Dilators	15
Bonney-berkeley Uterus Holding Forceps	2
Bozeman Dressing Forceps	05
Braun Cranioclast	29
Braun Stadler Episiotomy Scissors	02
Braun Uterine Double Ended	24
Braun Vulsellum Forceps	18
Breisky Ovum	31
Burke Biopsy Forceps	12
Busch Umbilical Cord Scissors	01
C	
Carton Mucous Evacuator	29
Cervical Dissecting Forcep	17
Collin Speculum	06
Collin Uterine Holding Forceps	24
Cornyn Berkeley Vulva Self Retaining	03
Currie Rubber Cone	27
Cusco Virgin Speculum	06-07
D	
Dartigue Uterine Holding Forceps	24
De Lee Midwifery Forceps	30
Denman Placenta Forceps	31
Doyen Myoma For Abdomen	27
Doyen Myoma For Vagina	27
Doyen Pozzi Retractor	03
Doyen Supra Hollow Handle	03
Doyen Vaginal Flat Retractor	03
Drewsmythe Iucd Uterine Hooks	28
Dubois Scissors	01
Duplay Vulsellum Forceps	17
E	
Eppendorf Biopsy Forceps	12
F	
Faure Biopsy Forceps	14
Female Bladder Sounds	05
Female Catherers	05
Fergusson Uterine Scissors	01
G	
Galabin Uterine Sounds	28
Gelpi Vulva Self Retaining	03
Goodwin Iucd Removal Forceps	28
Grafenberg	28
Graves (brewer) Virgin Speculum	07
Graves Vaginal Speculum Leep / Lietz	08
Graves Virgin Speculum	07
Graves Wide Virgin Speculum	07
Graves Wide Virgin Speculum	09
Green-armytage Iucd Removal Forceps	28
Greenhalgh Ovum Forceps	29
Gwilliam Uterus Holding Forceps	25
H	
Haig Ferguson Midwifery Forceps	30
Hank Double Ended	15
Hawkin Ambler Dilators	15
Hayes-provis	27
Heaney Uterus Holding Forceps	25
Hegar Double Ended Dilators	16
Hegar Single Ended	15
Hegar Uterine Dilator	16
Heywood Smith Ovum Forceps	29
Hormone Implant Trocar Set	05
Horrock Uterine Sounds	28
Hunter Uterus Holding Forceps	25
I	
Iris Skin Hooks	04
Iucd Removal Forceps	14
J	
Joll Thyroid Self Retaining	03
K	
Kelly Polypus Forceps	26
Kevorkian Endocervical Curettes	22

DESCRIPTION	PAGE #
Kevorkian Young Biopsy Forceps	12
Kielland Luikart Midwifery Forceps	30
Kielland Midwifery Forceps	30
Kogan Vulsellum Forceps	17
L	
Landon Vaginal Retractor	04
Lawson Tait Episiotomy Scissors	02
Leech Wilkinson Hysterectomy Clamps	27
Leechwilkinson Biopsy Forceps	12
Leechwilkinson Suction Biopsy Curettes	23
Luer Needle Extensions	05
Lewer Vulsellum Forceps	17
Luer Vulsellum Forceps + Sound	18
Luer Vulsellum Forceps	18
M	
Maingot Uterus Holding Forceps	25
Martin Ovum	31
Mccullagh Hysterectomy Clamps	26
McIntock Ovum Forceps	29
Milne Murray Midwifery Forceps	30
N	
Navrathil Hysterectomy Clamps	26
Novak Suction Biopsy Curettes	23
P	
Parametrium Hysterectomy Clamps	26
Pederson Vaginal Speculum Leep / Lietz	08
Pederson Virgin Speculum	08-09
Pinard Stethoscopes	31
Polypus Forceps	26
Pratt Double Ended Dilators	16
Provis Metal Cone	27
Provis Rubber Cone	27
R	
Randall Suction Biopsy Curettes	23
Recamier Uterine Curettes	19-21
Rheinstadter Flushing Curettes	23
Rotunda Catherers	05
Rotunda Vulsellum Forceps	18
S	
Schroeder Vulsellum Forcep	18
Schubert Biopsy Forceps	14
Schumacher Biopsy Forceps	13-14
Sharman Endometrial Biopsy Curettes	23
Simpson Midwifery Forceps	30
Simpson Placenta Forceps	31
Simpson Uterine Sounds	28
Sims Double Ended S/s	22
Sims Double Ended Sharp Blunt	22
Sims Single Ended Blunt	22
Sims Single Ended Sharp	22
Sims Uterine Double Ended	24
Sims Uterine Scissors	02
Sims Uterine Sounds	28
Sims Virgin Speculum	10
Somer Uterine Holding Forceps	24
Spackman Metal Cone	27
Spackman Rubber Cone	27
Spackman Rubber Only	27
T	
Tamier Midwifery Forceps	30
Teal Vulsellum Forceps	18
Tenaculum 3 Prong Skin Hooks	04
Tenaculum Emmett Skin Hooks	04
Thoms-gaylor Biopsy Forceps	14
Tischler Baby Biopsy Forceps	13
Tischler Biopsy Forceps	13
U	
Umbilical Dilators	31
Uterine Scissors	02
V	
Vaginal Dressing Forceps	05
Vaginal Lateral Wall Retractor	11
Van Doran Biopsy Forceps	14
W	
Weisman Graves Virgin Speculum	09
Weisman Virgin Speculum	08
Wertheim Hysterectomy Clamps	26
Wertheim Retractor	04
Whittaker Skin Hooks	04
Willet Placenta Forceps	29
Winter Cranioclast	29
Winterton Vaginal Speculum	10
Wittner Biopsy Forceps	13
Wrigley Midwifery Forceps	30



MANZIM SURGICO

We Are Manufacturer & Exporter of Gynecology/Obstetrics Instruments.

ADDRESS : R/CN 394 Near Islam Masjid Shatab Garh
P/o Small Industrial Estate Sialkot. 51310 Pakistan

TEL : 0092-52-3253436

FAX : 0092-52-3253436

MOBILE# 0092-300-5159397
0092-307-5311117

EMAIL : info@manzimsurgico.com
sales@manzimsurgico.com

WEB: www.manzimsurgico.com